

Hand-held LCR Meter

LCR-914/915/916 Series

USER MANUAL

GW INSTEK PART NO. 82CR-g1600MD1



ISO-9001 CERTIFIED
MANUFACTURER

GW INSTEK

This manual contains proprietary information, which is protected by copyright. All rights are reserved. No part of this manual may be photocopied, reproduced or translated to another language without prior written consent of Good Will company.

The information in this manual was correct at the time of printing. However, Good Will continues to improve products and reserves the right to change specification, equipment, and maintenance procedures at any time without notice.

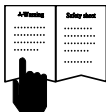

Read First **Safety Information**

Understand and follow the operating instructions carefully. Use the meter only as specified in this manual; otherwise, the protection provided by the meter may be impaired.

WARNING

Identifies hazardous conditions and actions that could cause **BODILY HARM** or **DEATH**.

CAUTION

Identifies conditions and actions that could **DAMAGE** the meter or equipment under test.

WARNING

- When using test leads or probes, keep your fingers behind the finger guards.
- Remove test leads from the Meter before opening the battery door or the Meter case.
- Use the Meter only as specified in this manual or the protection by the Meter might be impaired.
- Always use the correct terminals, switch positions, and ranges for measurements.
- Do not apply more than the rated voltage, as marked on Meter, between terminals or between any terminal and earth ground.
- Use caution with voltages above 30 Vac rms, 42 Vac peak, or 60 Vdc. These voltages pose a shock hazard.
- To avoid false readings that can lead to electric shock and injury, replace the battery when the low battery indicator appears.
- Discharge all high-voltage capacitors before testing.
- Do not use the Meter around explosive gas or vapor.
- To reduce the risk of fire or electric shock do not expose this product to rain or moisture.

**CAUTION**

- Never connect a source of voltage that could result in damage to the meter and the equipment under test.
- Do not expose the Meter to extremes in temperature or high humidity.

Symbols as Marked on the Meter and the Instruction Manual

	Risk of electric shock
	See instruction manual
	DC measurement
	Battery
	Fuse
	Earth
	AC measurement
	Conforms to EU directives
	Do not discard this product or throw away.

Maintenance

Do not attempt to repair this Meter. It contains no user serviceable parts. Repair or servicing should only be performed by qualified personnel.

Cleaning

Periodically wipe the case with a dry cloth and detergent. Do not use abrasives or solvents.

Meter Description

Front Panel Illustration

1. LCD display: 20000/2000 counts.
2. Function buttons.
3. 5-Wire input terminal for SMD test probe or DIP part.
4. 2-Wire input terminal for Alligator Clips.

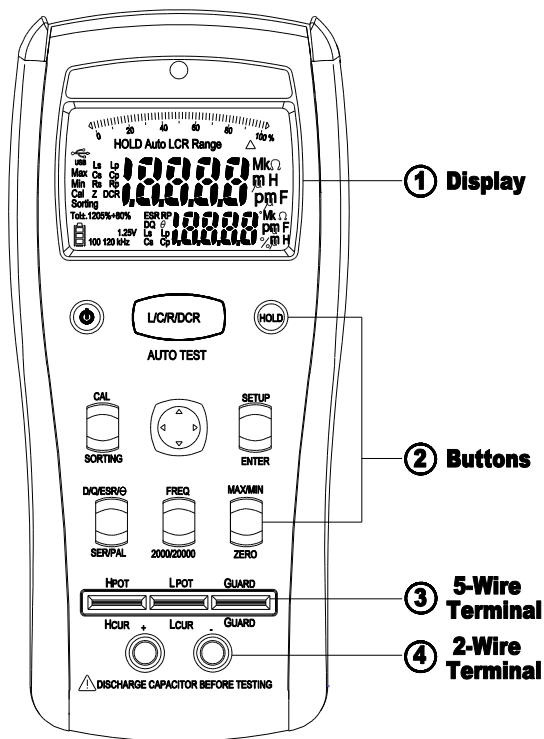

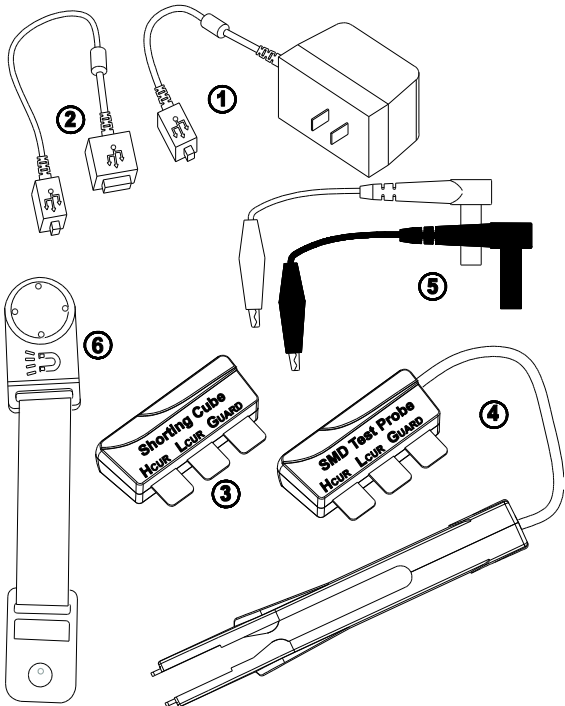
Package Contents

1. 5V AC Adapter (only LCR-916).
2. USB Cable (only LCR-916).
3. Shorting Cube.
4. SMD Test Probe (only LCR-916).
5. Alligator Clip Set.
6. Hanging Kit (only LCR-915/916).

Measuring Principles

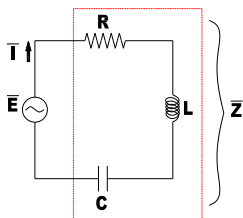

$$\bar{E} = R + j(X_L - X_C)$$

$$\bar{Z} = \sqrt{R^2 + (X_L - X_C)^2} \leq \tan^{-1} \left(\frac{X_L - X_C}{R} \right)$$

$$X_L = 2\pi fL = \omega L$$

$$X_C = \frac{1}{2\pi fC} = \frac{1}{\omega C}$$

$$\theta = \tan^{-1} \left(\frac{X_L - X_C}{R} \right)$$

$$Q = \frac{I}{D} = \tan \theta$$

Series Measurement



$$Z = R_s + jX_s$$

Parallel Measurement

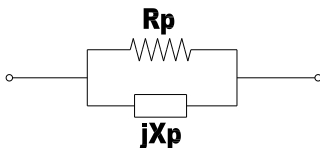

$$Y = \frac{1}{R_P} + \frac{1}{jX_P}$$

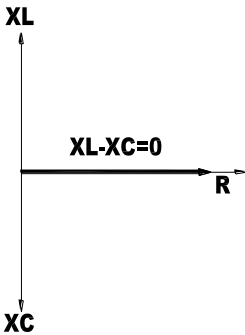
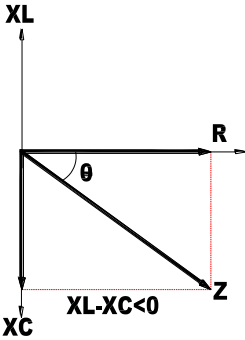
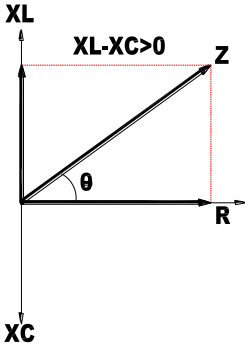
Phase Drawing

Making 5-Wire Measurements with the SMD Test Probe

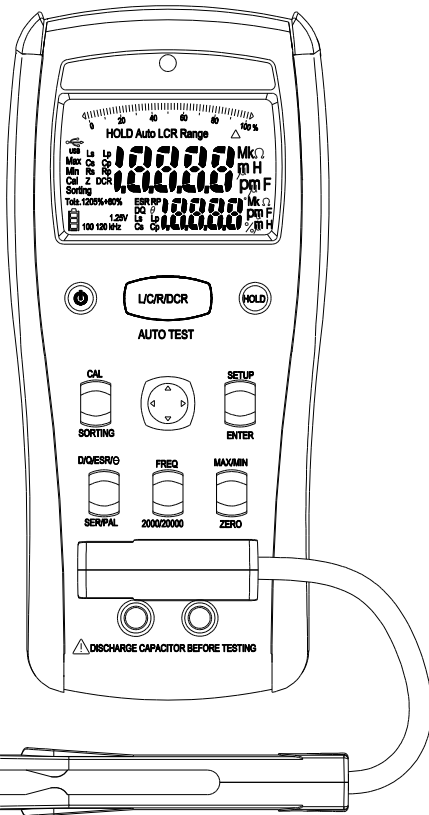

Making 4-Wire Measurements with the 5-Wire Terminal

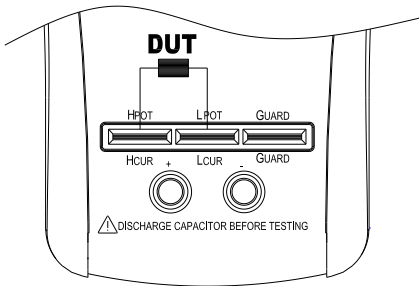

Making 2-Wire Measurements with the Alligator Clip Set

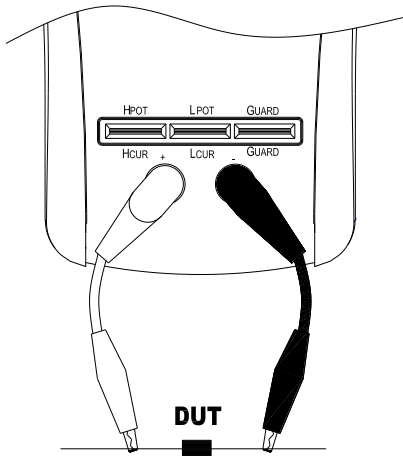

Measuring L/C/R/DCR

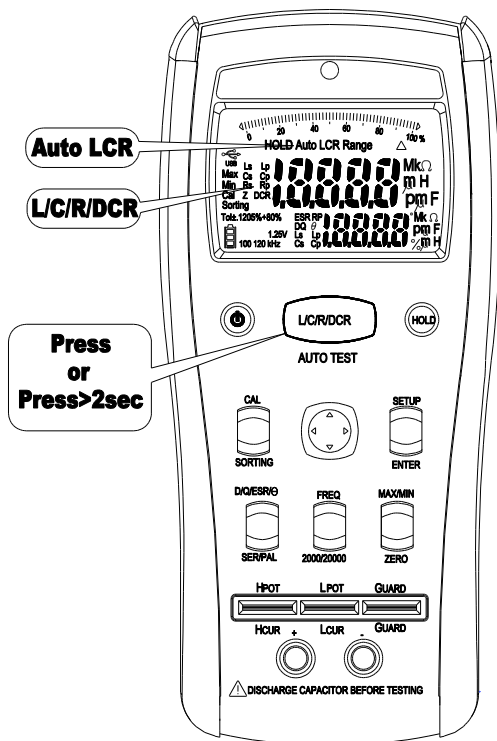

- Press the L/C/R/DCR button to select the measurement function.
- Press the L/C/R/DCR button for 2 seconds to enter the Auto L/C/R function.

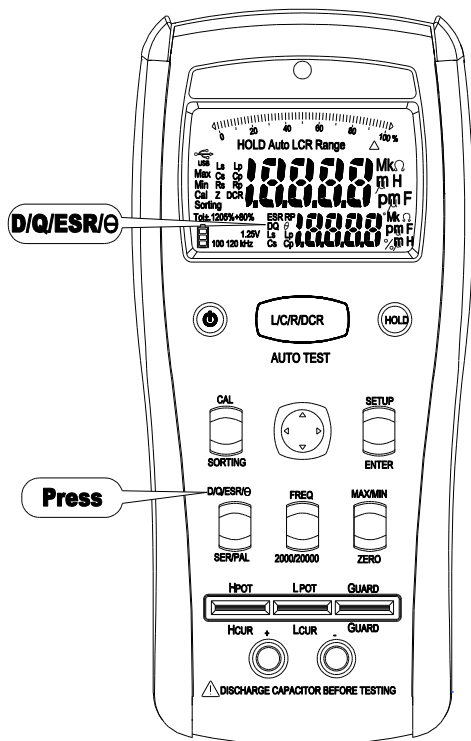
Measuring D/Q/ESR/ θ 

- Press the D/Q/ESR/ θ button to select the measurement function.

Selecting the Test Frequency

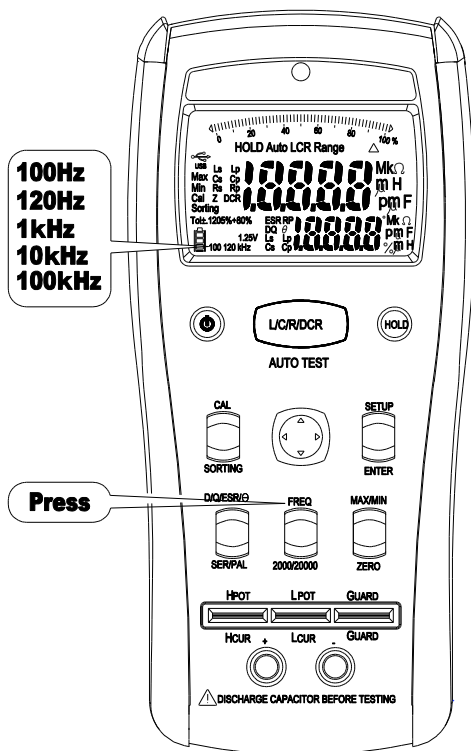

- Press the FREQ button to select the test frequency.
- The selectable frequency range depends on the model:
 - LCR-914: 100Hz, 120Hz, 1kHz.
 - LCR-915: 100Hz, 120Hz, 1kHz, 10kHz.
 - LCR-916: 100Hz, 120Hz, 1kHz, 10kHz, 100kHz.

Selecting the Series / Parallel Measurement Function

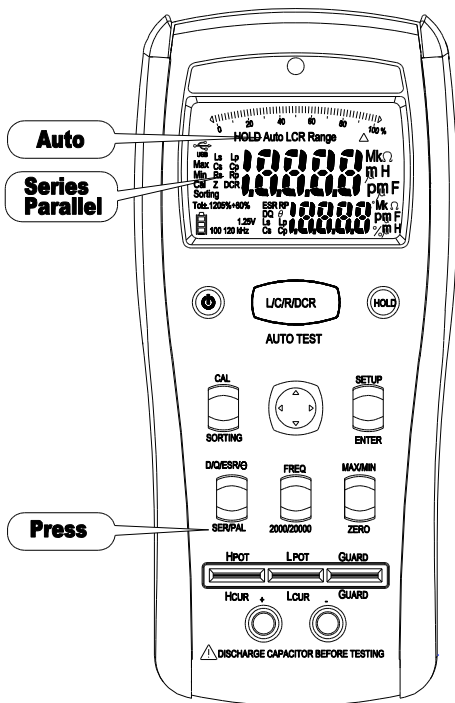

- At the L/C/R measuring function, it defaults to Auto Series / Parallel measuring function.
- Press the SER/PAL button to select the measuring function.

Selecting the Display Count

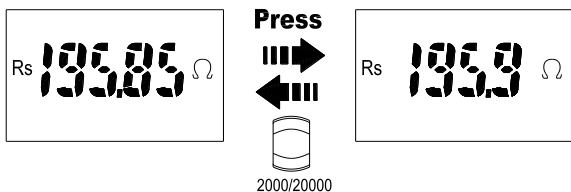

- Press the 2000 /20000 button to select the display count.

Zero

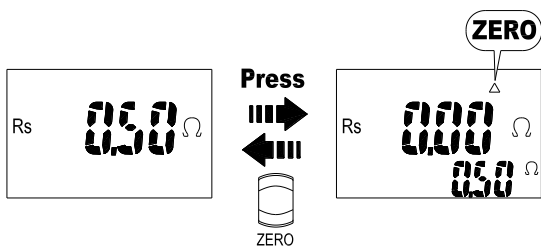

The Zero mode records the current input value as a reference and displays the reference on the sub display. Any inputs after this will be subtracted from the reference value and displayed on the main display. To use the Zero mode, follow the steps below.

1. Press the Zero button to enter Zero mode. The “Δ” symbol appears on the display.
2. Press the Zero button again to record a new input value as a reference.
3. Hold the Zero button for 2 seconds to exit this mode.

Display Hold

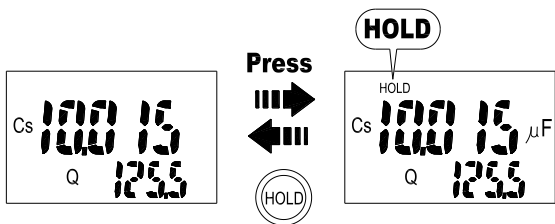

- Press the HOLD button to hold the reading on the meter, press the button again to return.

Display MAX/MIN

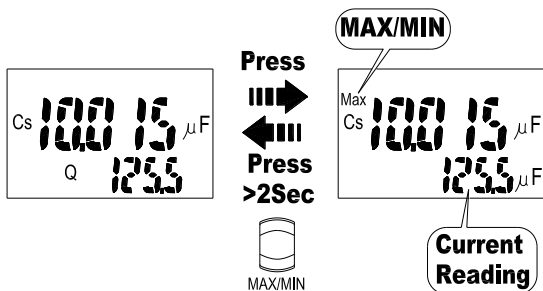

The MAX/MIN mode records the maximum and the minimum input values. When the inputs go below the recorded minimum value or above the recorded maximum value, the meter beeps and records the new value.

To use the MAX/MIN mode, follow the steps below:

1. Press the MAX/MIN button to enter the MAX/MIN mode. The "MAX" icon appears on the display. The maximum value is shown on the main display and the current value is shown on the sub display.
2. Press the MAX/MIN button to select the MAX or MIN mode.
3. Press the MAX/MIN button for 2 seconds to exit this mode.

Note: This function is only for LCR-916.

Calibration

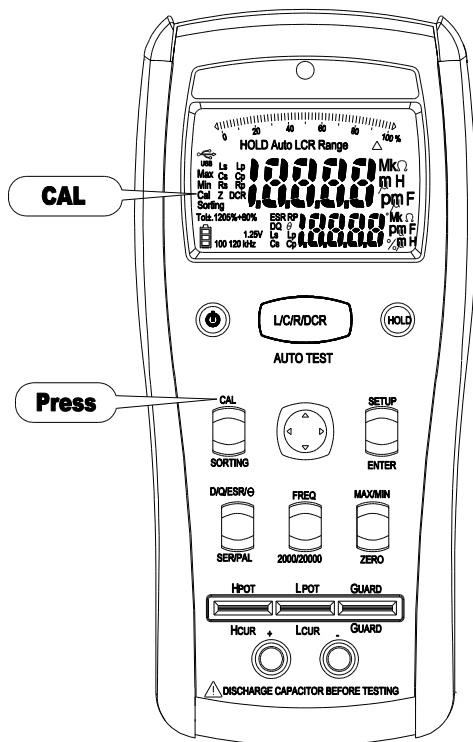

In order to achieve the best measurement results, calibration is essential. To calibrate the meter, press the CAL button.

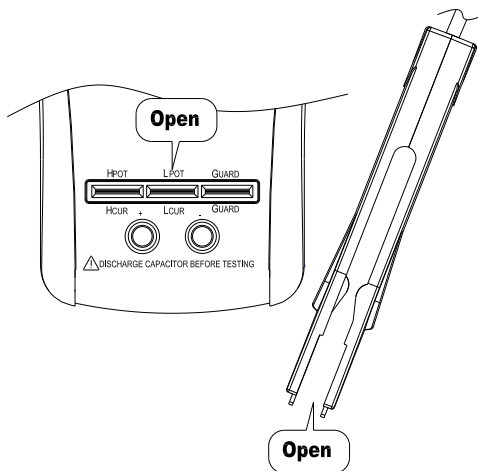
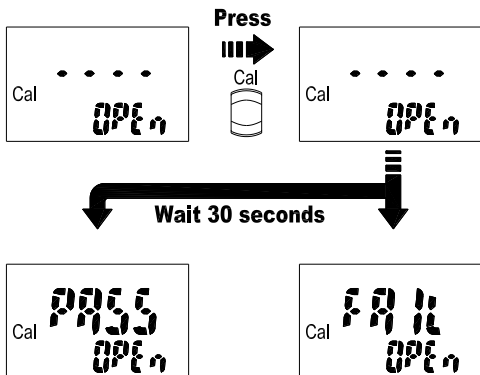

When “OPEn” appears on the sub display, make the terminal or the SMD test probe open, and press the CAL button to start the open calibration. About 30 seconds later, the result of the open calibration appears on the main display. If the result is “pass”, press the CAL button to proceed to the next step. If the result is “fail”, press the CAL button to exit the function.

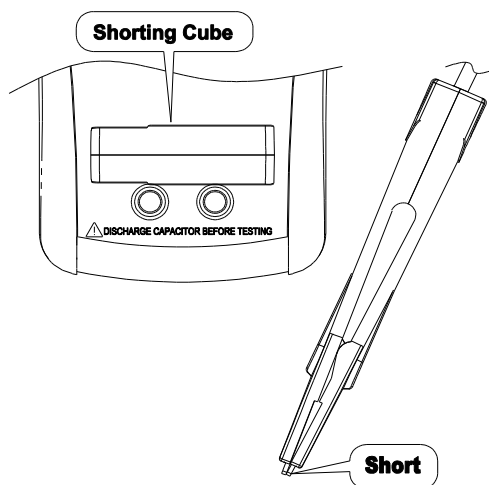
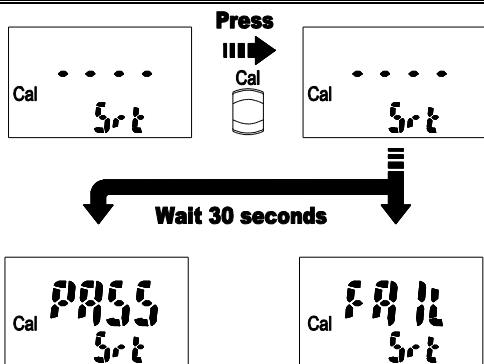

When “Srt” appears on the sub display, short the terminals or the SMD test probe, and then press the CAL button to start the short calibration. About 30 seconds later, the result of the short calibration appears on the main display. If the result is “pass”, press the CAL button to complete the calibration. If the result is “fail”, press the CAL button to exit the function.

Sorting

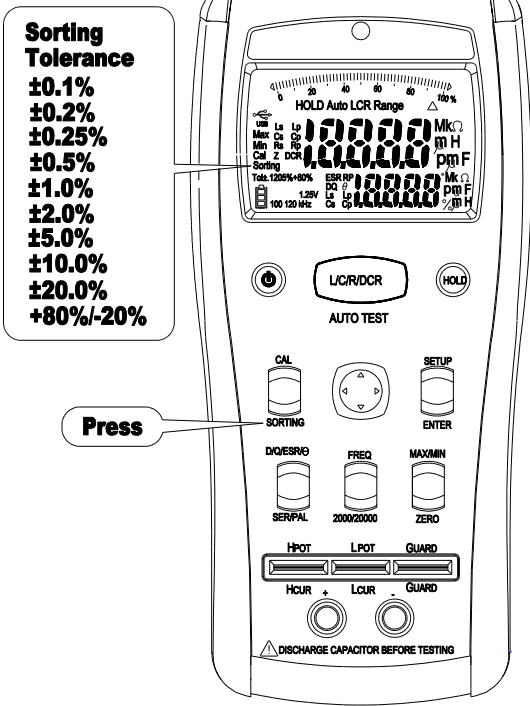

To check the accuracy of a part, press the SORTING button to enter the sorting mode. The sorting result appears on the main display, and the current value appears on the sub display.

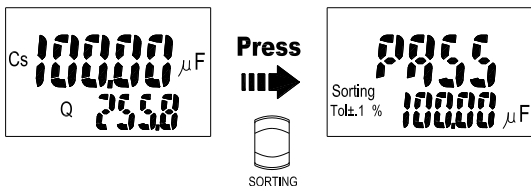

The default sorting standard value is the current value, and the default tolerance is $\pm 1.0\%$.

Setup Sorting Standard

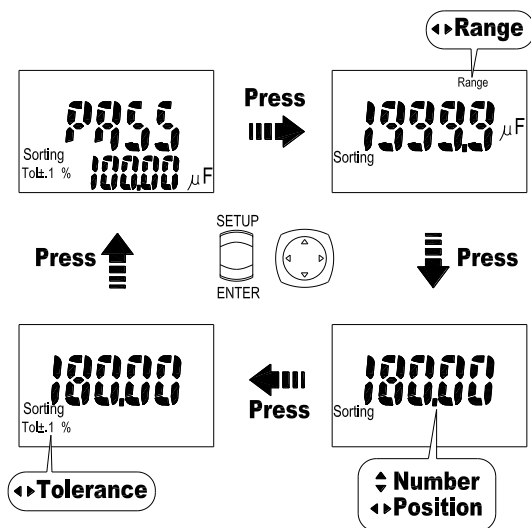

To setup the sorting standard value, follow the steps below:

1. Press the SETUP button to enter the setup mode.
2. Press \triangleleft and \triangleright button to setup the range of the standard value. Then press the ENTER button to save the setup value and enter the next step.
3. Press \triangle , ∇ , \triangleleft and \triangleright button to setup the standard value. Then press the ENTER button to save the setup value and enter the next step.
4. Press \triangleleft and \triangleright button to setup the tolerance value. Then press the ENTER button to save the setup value and exit this mode.

Battery Replacement

Refer to the following figure to replace the batteries :

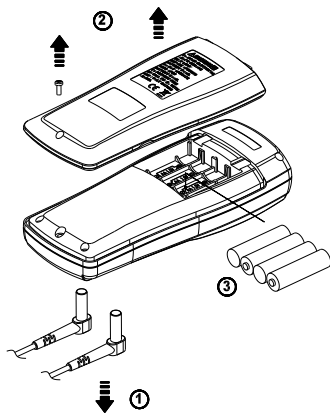

Caution

- Replace the batteries as soon as the low battery indicator  appears, to avoid false reading.
- 1.5V x 4 alkaline batteries.

External Power Source

Save battery power by using the external power source.

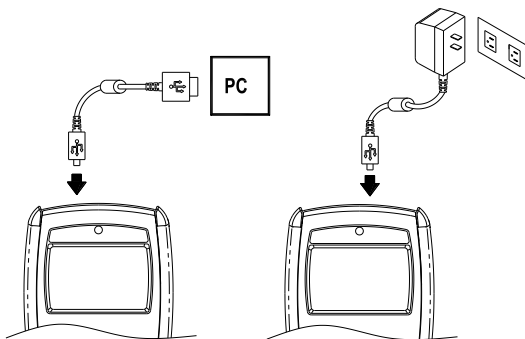

Caution

- Use the 5V AC adapter only as specified in this manual.
- Do not use other power sources with the meter.

Specifications

General Specifications

Maximum voltage applied to any terminal:

30V_{DC} or 30V_{AC} rms

Display: 2000/20000 counts

Overrange Indication: OL

Battery Life: 80 hours

Low Battery Indicator: "  " is displayed when the battery voltage drops below the operating voltage.

Low battery voltage: Approx. 4.5V

Auto Power Off: 10 minutes.

Operating Temperature: No-condensation $\leq 10^{\circ}\text{C}$,

11 $^{\circ}\text{C}$ ~ 30 $^{\circ}\text{C}$ ($\leq 80\%$ RH),

30 $^{\circ}\text{C}$ ~ 40 $^{\circ}\text{C}$ ($\leq 75\%$ RH),

40 $^{\circ}\text{C}$ ~ 50 $^{\circ}\text{C}$ ($\leq 45\%$ RH)

Storage Temperature:

-20 $^{\circ}\text{C}$ to 60 $^{\circ}\text{C}$, 0 to 80% R.H. (batteries not fitted)

Temperature Coefficient:

0.15 x (Spec.Accy) / $^{\circ}\text{C}$, < 18 $^{\circ}\text{C}$ or > 28 $^{\circ}\text{C}$.

Measurement: Samples 1.25 times per second normal.

Altitude: 6561.7 ft (2000m).

Weight: (630g) including battery.

Dimensions (W x H x D):

95mm x 207mm x 52mm with holster.

Accessories:

	Accessory	LCR-916	LCR-915	LCR-914
1.	Shorting Cube	Standard	Standard	Standard
2.	2Wire Alligator Clip Set	Standard	Standard	Standard
3.	Magnetic Hang Kit	Standard	Standard	Optional
4.	Battery	Standard	Standard	Standard
5.	User Manual	Standard	Standard	Standard
6.	SMD Test Probe	Standard	Optional	Optional
7.	AC Adapter	Standard	Optional	Optional
8.	USB Cable	Standard	Optional	Optional
9.	PC Software CD	Standard	Optional	N/A
10.	4Wire DIP Clip Set	Optional	Optional	Optional

Power Requirements: 1.5V x 4 IEC LR6 or AA size.

External Power Requirements: DC 5V (USB cable or AC adapter)

Pollution Degree: 2

Safety: Complies with EN 61010-1, IEC 61010-1

EMC: EN 61326-1

Shock Vibration: Sinusoidal vibration per MIL-T- 28800E (5 ~ 55 Hz, 3g maximum).

Drop Protection: 4 feet drop to hardwood on concrete floor.
Indoor Use.

Electrical Specifications

(1) Test Frequency

Selectable Frequencies	Accuracy
100 Hz	± 0.02%
120 Hz	± 0.02%
1 kHz	± 0.02%
10 kHz ^[1]	± 0.02%
100 kHz ^[2]	± 0.02%

[1] The 10kHz test frequency is only for the LCR-915/916.

[2] The 100kHz test frequency is only for the LCR-916.

(2) Test Signal

AC Signal Level: 600mVrms

AC Signal Accuracy: ±10%

DC Bias Level: 1V

DC Bias Accuracy: ±10%

(3) Test Cable

Model	Length	Bandwidth	Type
SMD Test Probe	60cm	1MHz	5-Wire
4-Wire Test Probe	60cm	1MHz	5-Wire
Alligator Clip Set	15cm	1kHz	2-Wire

Accuracy: ±(A x B)(% of reading)

A: Basic Accuracy as specified by

B: Test Cable Accuracy

$B(\%) = 1 + (L \times F \times T)$

L(m): Cable length

F(MHz): Test frequency

T: Cable type. If the cable is 5-wire type, then "T" is 40, else "T" is 4,000.

When measuring by basic accuracy, the following conditions must be met:

1. Ambient temperature: 23°C ± 5°C < 80% RH.
2. Test cable length: 0m
3. Open and short calibration has been performed
4. $D \leq 0.1$ for C, L measurements; $Q \leq 0.1$ for R measurements.

See the operation manual for additional details.

(4) Inductance

Frequency	Range	Accuracy
100Hz 120Hz	20.000mH	$\pm (0.5\% + 5d)$
	200.00mH	$\pm (0.2\% + 2d)$
	2000.0mH	
	20.000H	
	200.00H	
	2000.0H	$\pm (0.5\% + 2d)^{[3]}$
	20.000kH	$\pm (1.0\% + 2d)^{[3]}$
1kHz	2000.0uH	$\pm (0.5\% + 5d)$
	20.000mH	$\pm (0.2\% + 2d)$
	200.00mH	
	2000.0mH	
	20.000H	
	200.00H	$\pm (0.5\% + 2d)^{[3]}$
	2000.0H	$\pm (1.0\% + 2d)^{[3]}$
10kHz ^[1]	200.00uH	$\pm (0.5\% + 5d)$
	2000.0uH	$\pm (0.2\% + 2d)$
	20.000mH	
	200.00mH	$\pm (2.0\% + 2d)$
	2000.0mH	$\pm (5.0\% + 2d)$
	20.000H	
100kHz ^[2]	20.000uH	$\pm (0.5\% + 5d)$
	200.00uH	$\pm (0.2\% + 2d)$
	2000.0uH	
	20.000mH	$\pm (2.0\% + 2d)$
	200.00mH	$\pm (5.0\% + 2d)$

[1] The 10kHz test frequency is only for the LCR-915/916.

[2] The 100kHz test frequency is only for the LCR-916.

[3] When using the external power, the accuracy is unspecified.

Input Protection: $30V_{DC}$ or $30V_{AC}$ rms

Minimum Resolution: 0.001uH in the 20.000uH range.

Measuring Time: 1 ~ 6 seconds

Note: If $D > 0.1$, the accuracy should be multiplied by $\sqrt{1+D^2}$

(5) Capacitance

Frequency	Range	Accuracy	
100Hz 120Hz	2000.0pF	$\pm (0.5\% + 5d)^{[3]}$	
	20.000nF ^[3]	$\pm (0.2\% + 2d)$	
	200.00nF		
	2000.0nF		
	20.000uF		
		200.00uF	$\pm (0.5\% + 2d)$
		2000.0uF	$\pm (1.0\% + 2d)$
		20.000mF	$\pm (2.0\% + 2d)$
1kHz	2000.0pF	$\pm (0.5\% + 5d)^{[3]}$	
	20.000nF ^[3]	$\pm (0.2\% + 2d)$	
	200.00nF		
	2000.0nF		
		20.000uF	$\pm (0.5\% + 2d)$
		200.00uF	$\pm (1.0\% + 2d)$
		2000.0uF	$\pm (2.0\% + 2d)$
10kHz ^[1]	200.00pF	$\pm (0.5\% + 5d)$	
	2000.0pF	$\pm (0.2\% + 2d)$	
	20.000nF		
	200.00nF		
	2000.0nF		
		20.000uF	$\pm (2.0\% + 2d)$
		200.00uF	$\pm (5.0\% + 2d)$
100kHz ^[2]	20.000pF	$\pm (0.5\% + 20d)$	
	200.00pF	$\pm (0.2\% + 2d)$	
	2000.0pF		
	20.000nF		
	200.00nF		
		2000.0nF	$\pm (2.0\% + 2d)$
		20.000uF	$\pm (5.0\% + 2d)$

[1] The 10kHz test frequency is only for the LCR-915/916.

[2] The 100kHz test frequency is only for the LCR-916.

[3] When using the external power, the accuracy is unspecified.

Input Protection: 30V_{DC} or 30V_{AC} rms

Minimum Resolution: 0.001pF in the 20.000pF range.

Measuring Time: 1 ~ 6 seconds

Note: If $D > 0.1$, the accuracy should be multiplied by $\sqrt{1 + D^2}$

(6) Resistance

Frequency	Range	Accuracy
100Hz 120Hz	200.00Ω	± (0.2% + 5d)
	2.0000kΩ	± (0.2% + 2d)
	20.000kΩ	
	200.00kΩ	
	2.0000MΩ	
	20.000MΩ	± (0.5% + 2d) ^[3]
	200.00MΩ	± (1.0% + 2d) ^[3]
1kHz	20.000Ω	± (0.5% + 5d)
	200.00Ω	± (0.2% + 2d)
	2.0000kΩ	
	20.000kΩ	
	200.00kΩ	
	2.0000MΩ	± (2.0% + 2d) ^[3]
	20.000MΩ	
10kHz ^[1]	20.000Ω	± (0.5% + 5d)
	200.00Ω	± (0.2% + 2d)
	2.0000kΩ	
	20.000kΩ	
	200.00kΩ	
	2.0000MΩ	± (2.0% + 2d)
	20.000MΩ	± (5.0% + 2d)
100kHz ^[2]	20.000Ω	± (0.5% + 5d)
	200.00Ω	± (0.2% + 2d)
	2.0000kΩ	
	20.000kΩ	
	200.00kΩ	± (2.0% + 2d)
	2.0000MΩ	± (5.0% + 2d)

[1] The 10kHz test frequency is only for the LCR-915/916.

[2] The 100kHz test frequency is only for the LCR-916.

[3] When using the external power, the accuracy is unspecified.

Input Protection: 30V_{DC} or 30V_{AC} rms

Minimum Resolution: 0.001Ω in the 20.000Ω range.

Measuring Time: 1 ~ 6 seconds

Note: If $Q > 0.1$, the accuracy should be multiplied by $\sqrt{1+Q^2}$

(7) DCR

Range	Resolution	Accuracy
200.00Ω	0.01Ω	± (0.2% + 5d)
2.0000kΩ	0.0001kΩ	± (0.2% + 2d)
20.000kΩ	0.001kΩ	
200.00kΩ	0.01kΩ	
2.0000MΩ	0.0001MΩ	
20.000MΩ	0.001MΩ	± (0.5% + 2d) ^[2]
200.00MΩ	0.01MΩ	± (1.0% + 2d) ^{[1][2]}

[1] < 50dgt rolling.
 [2] When using the external power, the accuracy is unspecified.

Input Protection: 30V_{DC} or 30V_{AC} rms

Minimum Resolution: 0.01Ω in the 200.00Ω range.

Measuring Time: 2 ~ 12 seconds

(8) D & Q

Definition Q=1/D

Range: 2.000 ~ 2000

Minimum Resolution: 0.001 in the 2.000 range.

Accuracy: Accuracy of Main Reading x (1+D)

Input Protection: 30V_{DC} or 30V_{AC} rms

Note: When equipped with the external power the accuracy is unspecified.

(9) ESR

The specification for ESR is the same as Resistance.

(10) θ

Range	Resolution	Accuracy
-90.0° ~ 90.0°	0.1°	± (0.2% + 5d)

Input Protection: 30V_{DC} or 30V_{AC} rms

Note: When equipped with the external power the accuracy is unspecified.