

HIOKI

POWER ANALYZER PW3390



High Accuracy Power Analysis.
Anywhere, Anytime.



3 year
Warranty



Scan QR Code to
Watch Video

Ver 2.00
Newly Added Functions

High Accuracy and Mobility. A New Value for Power Analysis.

The first-generation Power Analyzer 3390 debuted in 2009 with a collection of the latest measurement technologies packed into a compact design.

Pair with Hioki current sensors and take them anywhere to immediately make highly accurate measurements.

This was the unique value of the 3390.

Now, Hioki has enhanced this value while refining the measurement technology even further.

Proper accuracy and bandwidth to precisely measure inverter output.

Phase shift function for the exact measurement of high frequency, low power factor power.

A broad current sensor lineup that expands the range of measurement possibilities.

Refinements that empower you to conduct precise power analysis in any situation.



Complete Pursuit of Measurement Accuracy and High Frequency Characteristics

The PW3390 delivers 4 input channels and $\pm 0.04\%$ basic accuracy for power - the top instrument in its class. Achieve more precise measurements of the power and efficiency of high efficiency equipment used in power electronics. Further, a 200 kHz measurement band and flat amplitude and phase characteristics up to high frequencies enable the precise measurement of power at top frequency levels and low power factor.

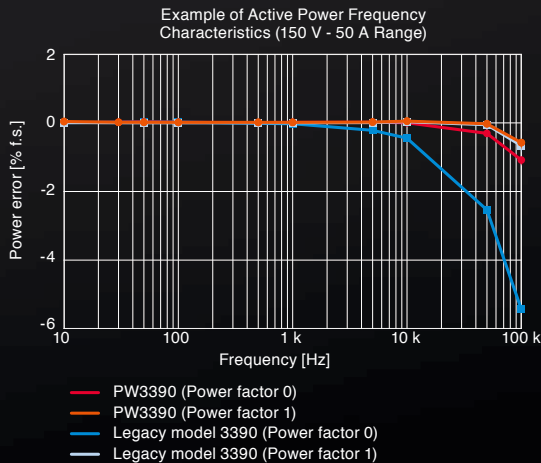

Power Analysis Engine That Achieves High-Speed Simultaneous Calculation on 5 Systems

Precisely capture input waveforms with 500 kS/s high-speed sampling and a high resolution 16-bit A/D converter. The power analysis engine performs independent digital processing for 5 systems: period detection, wideband power analysis, harmonic analysis, waveform analysis, and noise analysis. High-speed simultaneous calculation processing enables both precise measurements and a 50 ms data refresh rate.

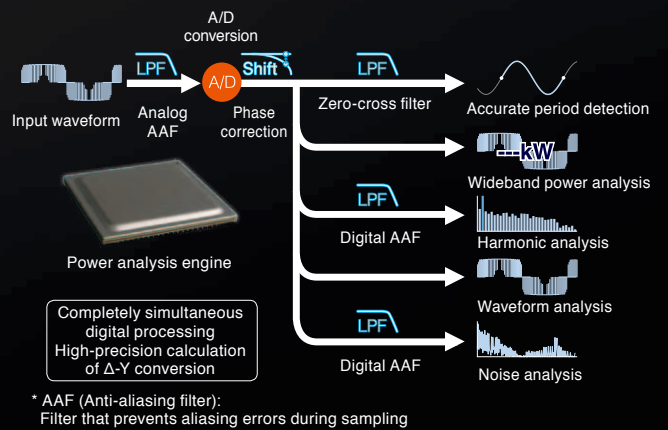

Current Sensors for the Thorough Pursuit of High Accuracy. Achieve Superior Accuracy for High-Frequency, Low Power Factor Power.

High Accuracy Pass-Through Sensor

Pass-through sensors deliver accuracy, broad-band performance, and stability. Measure currents of up to 1000 A with a high degree of accuracy across a broad range of operating temperatures.



High Accuracy Clamp Sensor

Clamp for quick and easy connections. Conduct extremely accurate measurements of large currents to a maximum of 1000 A over a wide operating temperature range.



High Accuracy Direct Wiring Sensor

Newly developed DCCT method delivers expansive measurement range and superior measurement accuracy at a rating of 50 A.



Built-in Current Sensor Phase Shift Function

Equipped with new virtual oversampling technology. Achieve phase shift equivalent to 200 MS/s while maintaining a high speed of 500 kS/s, as well as a high resolution of 16 bits. Set and correct the phase error of the current sensor at a resolution of 0.01°. Use of the phase shift function results in a dramatic reduction of measurement error. This allows the measurement of high-frequency, low-power factor power included in the switching frequency of inverter output, which is difficult to measure with conventional equipment.

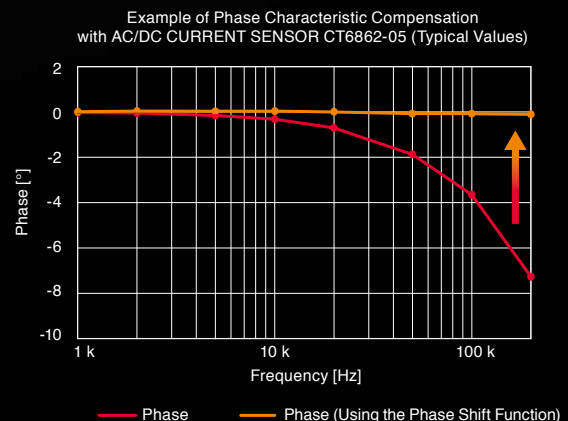

* Virtual oversampling: Technology that uses a sampling frequency several hundred times higher than the actual sampling frequency to perform virtual deskewing



Scan QR Code to Watch a Video of our Full Lineup of Current Sensors



Scan QR Code to Download Technical Brief About Current Sensor Phase Shift

In the Laboratory or in the Field

Take Highly Accurate Measurements Even in Tough Temperature Conditions

Severe temperature environments, such as engine rooms with intense temperature changes and constant temperature rooms, can hinder high accuracy measurements. The extremely accurate pass-through and clamp type sensors both feature excellent temperature characteristics and a wide operation temperature range to help address these challenges.



Max. 6000 A Measurement on 50 Hz/60 Hz Lines

The CT7040 AC FLEXIBLE CURRENT SENSOR series can measure commercial power lines up to 6000 A, including solar power conditioner output. Even thick cables can be wired easily among crowded wiring or in narrow locations.



Acquire Data from up to 8 Synchronized Units (32 Channels)

When you connect CONNECTION CABLE 9683 to multiple PW3390 units, the control signals and internal clocks synchronize. From the master unit, you can control the measurement timing on the PW3390 units that are set as slaves. With interval measurement, you can save synchronized measurement data to a CF card or a PC to achieve simultaneous measurements across a larger number of systems.

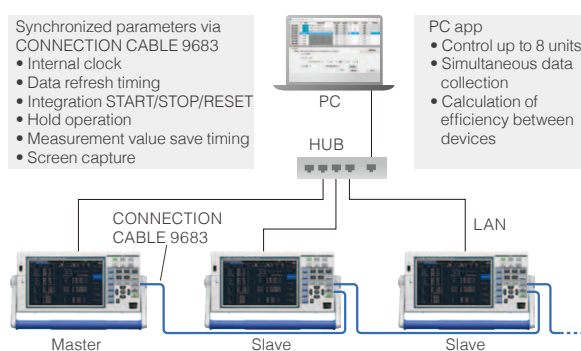

Achieve High Accuracy Measurement Even in the Field

Dramatically compact and light-weight form factor achieved by concentrating the calculation functions in the power analysis engine. Highly accurate measurements normally achieved in the laboratory are now also possible in the field.



External Power Supply Not Needed for Sensor Connections

Power can be supplied to the current sensor from the main unit, so there is no need to provide a separate external power supply for the current sensor. Connected sensors are recognized automatically, for reliable and quick measurements.



Wiring Displays and Quick Setup Lets You Begin Measuring Immediately

Perform wiring while checking wiring diagrams and vectors on the screen. Optimum settings are performed automatically simply by selecting a connection and using the quick setup function.

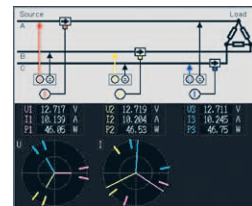

Extensive Interface for Linking with External Devices

Wide variety of built-in interfaces, including LAN, USB (communication, memory), CF cards, RS-232C, synchronization control, and external control.

D/A output* delivers analog output at 50 ms for up to 16 parameters. The voltage and current waveform** for each channel can also be output.

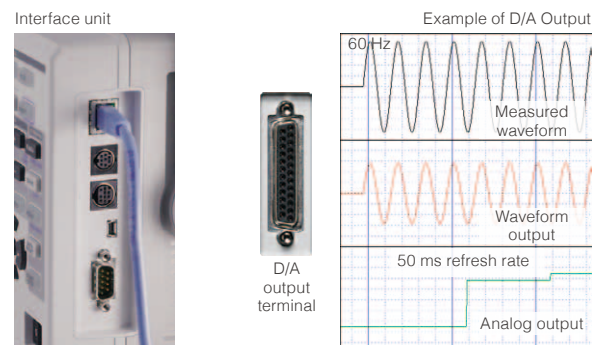

* Built-in for PW3390-02 and PW3390-03

** During waveform output, accurate reproduction is possible at an output of 500 kS/s and with a sine wave up to 20 kHz.

Switch Screens with a Single Touch, Accessing a Variety of Power Analysis Methods

The power analysis engine allows the simultaneous, parallel calculation of all parameters. Access a variety of analysis methods simply by pressing the page keys to switch screens.



Page Keys

Vector

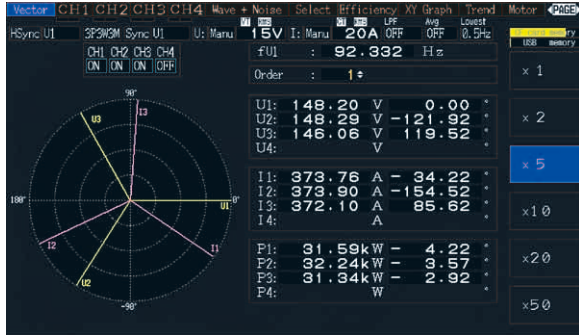

Confirm the voltage/current/power/phase angle for each channel order on a vector graph and as numerical values.

Selection Display

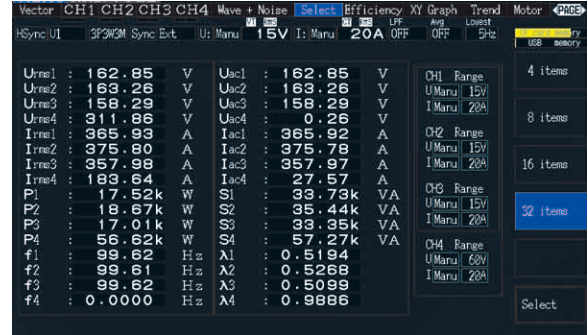

Select 4/8/16/32 display parameters individually for each screen, and summarize them on a single screen.

Waveform



Display voltage/current waveforms for 4 channels at a high speed of 500 kS/s or a maximum length of 5 seconds. Waveform data can be saved.

Noise



Display FFT results for voltage and current as graphs and numerical values, up to a maximum of 200 kHz. This is perfect for the frequency analysis of inverter noise.

Harmonics Graph



Display harmonics up to the 100th order for voltage/current/power in bar graphs. Confirm the numerical data for the selected order at the same time.

Trend



Choose up to eight measurement parameters and display a graph of their variations over time. You can also save a screenshot of the graph.

Efficiency and Loss



Using active power values and motor power values, confirm efficiency η [%] and loss [W] and total efficiency for each inverter/motor on a single unit at the same time.

X-Y Graph

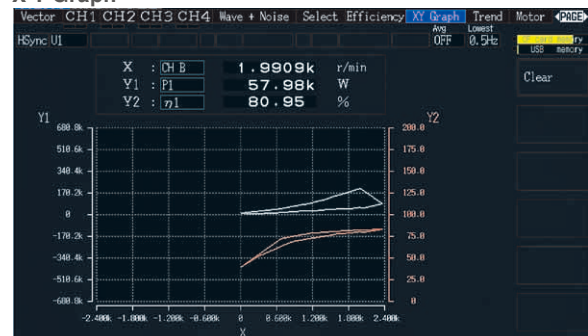

Create inverter characteristic evaluations and motor torque maps. Select the desired parameter to display an X-Y plot graph.

Applications

Measure the Power Conversion Efficiency of Inverters

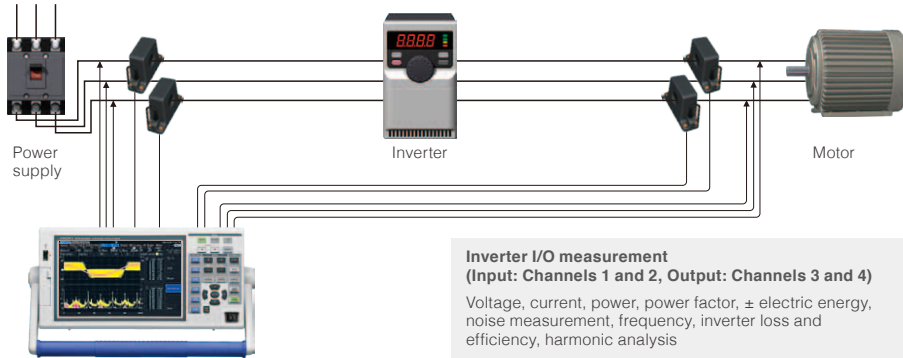

Key features

1. Isolated input of voltage and current on each of 4 channels for simultaneous measurement of the primary and secondary power of inverters
2. Simultaneous measurement of all important parameters for secondary analysis of inverters, such as RMS value, MEAN value, and fundamental components
3. Easy wiring with current sensors. Reliable confirmation of wiring with vector diagrams
4. Current sensors reduce effects of common mode noise from inverters during power measurement
5. Simultaneous measurement of noise components, in addition to the harmonic analysis required for the measurement of inverter control

Highly Accurate and Fast 50 ms Calculation of Power in Transient State

Measure power transient states, including motor operations such as starting and accelerating, at 50 ms refresh rates. Automatically measure and keep up with power with fluctuating frequencies, from a minimum of 0.5 Hz.

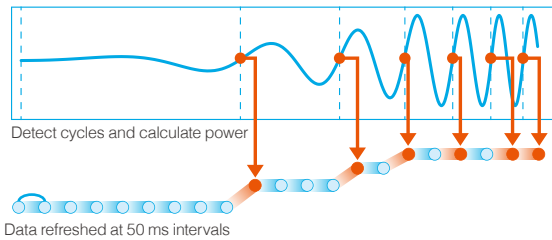

Automatic detection of fundamental wave even if the frequency fluctuates, from low to high frequencies

Combined Accuracy of Current Sensors Applicable throughout Entire Range

Combined accuracy throughout the entire range is provided through the use of a built-to-order high accuracy pass-through type current sensor. Obtain highly accurate measurements regardless of range, from large to minute currents, even for loads that fluctuate greatly.

Legacy Model 3390

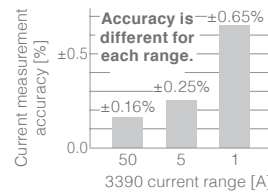

Model PW3390

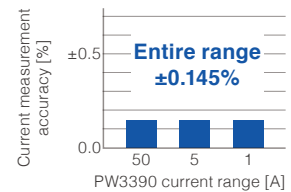

Combination of 3390 and CT6862-05 (50 A rating)
Total Accuracy when measuring frequency of 45 to 66 Hz and f.s. for each range

Combination of PW3390 and the high accuracy CT6862-05* (50 A rating, built-to-order)
Total accuracy when measuring frequency of 45 to 66 Hz and f.s. for each range

* High-accuracy specifications are not defined for the built-to-order high accuracy current sensor when used alone.

Evaluate high-frequency noise from an inverter Ver 2.00

The enhanced noise analysis functionality provided by Version 2.00 of the instrument's firmware lets you perform frequency analysis of noise components from DC to 200 kHz, display and automatically save the top 10 points, and manually save the FFT spectrum. This functionality is an effective tool for evaluating conductive noise from 2 kHz to 150 kHz generated by inverters and switching power supplies.



Visually assess temporal fluctuations in efficiency Ver 2.00

The trend display lets you graph user-selected measurement parameters such as efficiency and frequency over periods of time ranging from dozens of seconds to half a month. This capability makes it possible to visually assess fluctuations, including of transient states in which measured values fluctuate abruptly and steady states in which they exhibit minuscule fluctuations. Graphs can be saved as screenshots, and values can be automatically saved.

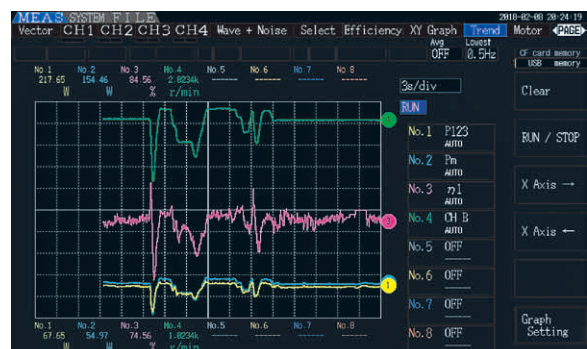

Analyze and Measure EV/HEV Inverter Motors

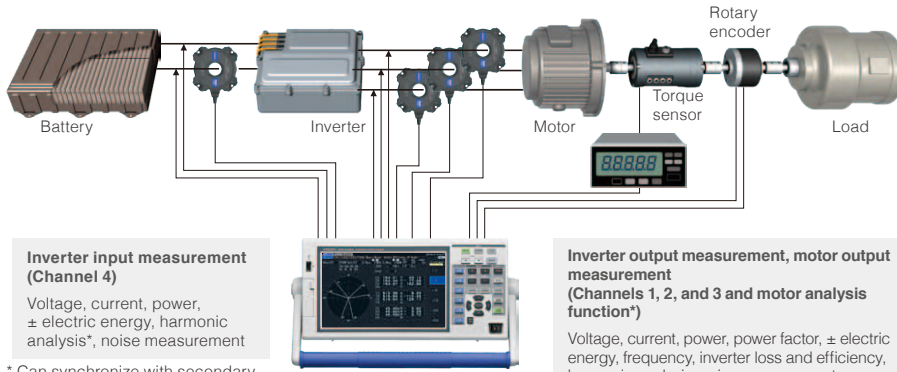

Inverter input measurement (Channel 4)
Voltage, current, power, ± electric energy, harmonic analysis*, noise measurement

* Can synchronize with secondary side to analyze harmonic components that overlap with DC.

Inverter output measurement, motor output measurement (Channels 1, 2, and 3 and motor analysis function*)

Voltage, current, power, power factor, ± electric energy, frequency, inverter loss and efficiency, harmonic analysis, noise measurement, rotation rate, torque, slip, motor power

* PW3390-03 is required for motor analysis. The user must provide a torque sensor and rotation sensor.

Key features

1. Easy wiring and highly accurate measurements with the use of a pass-through type current sensor
2. Simultaneous measurement of all important parameters for secondary analysis of inverters, such as RMS value, MEAN value, and fundamental components
3. 0.5 Hz to 5 kHz harmonic analysis without external clock
4. Total measurement of inverter motors with built-in motor analysis function
5. Measurement of the voltage, torque, rotation rate, frequency, slip, and motor power required for motor analysis with a single unit
6. More precise measurements of electrical angle with incremental type encoders

Electric Angle Measurement of Motors (PW3390-03 only) Ver 2.00

The PW3390-03 features a built-in electric angle measurement function required for vector control via dq coordinate systems in high-efficiency synchronized motors. Make real-time measurements of phase angles for voltage and current fundamental wave components based on encoder pulses. Further, zero-adjustment of the phase angle when induced voltage occurs allows electric angle measurement based on the inductive voltage phase. Version 2.00 of the firmware introduces the ability to display and manually set phase zero-adjustment values, making it possible to measure electrical angle using a user-selected zero-adjustment value. Electric angle can also be used as an Ld and Lq calculation parameter for synchronized motors.

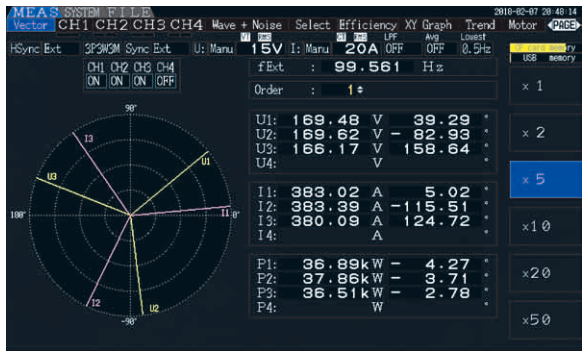

Display motor electric angles on the vector screen

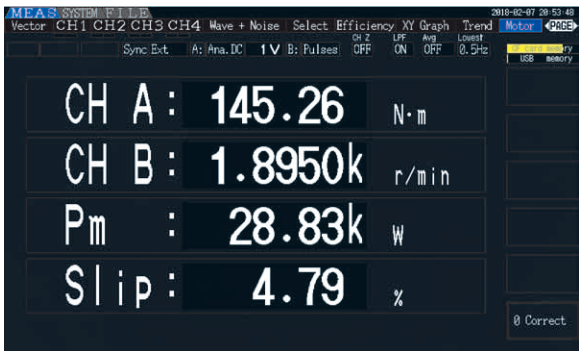

Motor analysis screen (Torque, rotation rate, motor power, slip)
For CH B, enter the Z-phase pulse of the encoder to measure electric angle, and enter the B-phase pulse to measure rotation direction.

Evaluate inverter motor efficiency and loss

Evaluate efficiency and loss for an inverter, motor, and overall system by simultaneously measuring the inverter's input and output power and the motor's output. You can also create an efficiency map or loss map in MATLAB using measurement results recorded by the PW3390 at each operating point. *MATLAB is a registered trademark of Mathworks, Inc.

Example of an efficiency map display in MATLAB

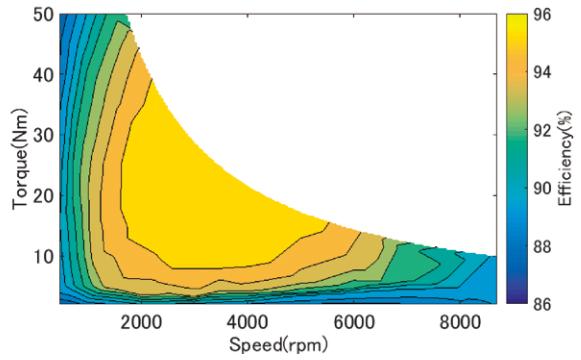

Transfer to Data Logger via Bluetooth® wireless technology

Connect the PW3390 and a data logger (with support of LR8410 Link) via Bluetooth® wireless technology to wirelessly transmit 8 parameters of measurement values from the PW3390 to the data logger. In addition to the voltage, temperature, humidity, and other parameters measured by the multichannel data logger, you can also integrate the measurement values of the PW3390 and observe and record them in real time.

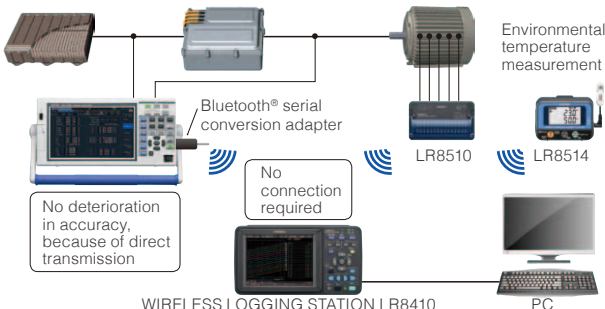

* Connection requires the serial - (Bluetooth® wireless technology) conversion adapter and power supply adapter recommended by Hioki. Please inquire with your Hioki distributor.

Measure the Efficiency of PV Power Conditioners (PCS)

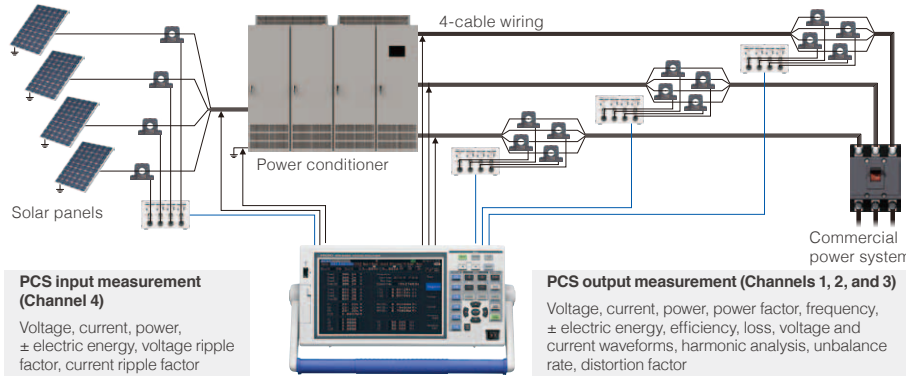

Key features

1. 4 built-in channels, standard. Simultaneously measure the I/O characteristics of power conditioners.
2. Current sensors can measure even large currents with high accuracy. Reliable confirmation of wiring with vector diagrams.
3. Measure the amount of power sold/purchased from power conditioner output on interconnected systems with a single unit.
4. DC mode integration function, which responds quickly to input fluctuations such as with solar power, built in.
5. Measure ripple factor, efficiency, loss, and all other parameters that are required for the measurement of power conditioners for solar power with a single unit.

HIOKI's Current Measurement Solutions for Large Currents of 1000 A or More

Introducing a lineup of sensors taking measurements up to 6000 A for 50 Hz/60 Hz, and up to 2000 A for direct current. The CT9557 SENSOR UNIT lets you add the output waveforms from multiple high accuracy sensors. Use multi-cable wiring lines to take highly accurate measurements of up to 8000 A.

Blue: High accuracy sensor Black: Normal sensors

Recommended current sensor by measurement target	DC power	System power 50 Hz/60 Hz	Inverter secondary power
1000 A or less	CT6876 or CT6846-05		
Single-cable or bundled wiring	2000 A or less	CT6877 or CT7742	CT6877 or CT7642
	6000 A or less	—	CT7044/CT7045/CT7046
2-cable wiring	2000 A or less	CT9557+CT6876x2 or CT9557+CT6846-05x2	
	4000 A or less	CT9557+CT6877x2	
3-cable wiring	3000 A or less	CT9557+CT6876x3 or CT9557+CT6846-05x3	
	6000 A or less	CT9557+CT6877x3	
4-cable wiring	4000 A or less	CT9557+CT6876x4 or CT9557+CT6846-05x4	
	8000 A or less	CT9557+CT6877x4	

- CT6865-05 (AC/DC 1000 A)
Pass-through type; Wideband, high accuracy
- CT6877 (AC/DC 2000 A)
Pass-through type; Wideband, high accuracy
- CT6846-05 (AC/DC 1000 A)
Easy-connect clamp type
- CT9557
Add waveforms from multiple current sensors
- CT7742 (AC/DC 2000 A)
Stable measurement of DC without zero offset
- CT7642 (AC/DC 2000 A)
Wider frequency characteristics than the CT7742
- CT7044/ CT7045/ CT7046 (AC 6000 A)
Flexible, for easy connections even in narrow gaps

Support for PCS Parameters

Simultaneously display the parameters required for PCS, such as efficiency, loss, DC ripple factor, and 3-phase unbalance rate. Easily check the required measured items for improved test efficiency. By matching the measurement synchronization source for both input and output, you can perform DC power measurements that are synchronized with the output AC as well as stable efficiency measurements.

P_4	:	8.396k	W	DC power (panel output)
P_{123}	:	7.850k	W	3-phase power (PCS output)
η_1	:	93.498	%	Conversion efficiency
U_{rF4}	:	0.212	%	Ripple factor
f_1	:	50.319	Hz	Frequency
U_{thd1}	:	2.390	%	Voltage total harmonic distortion
U_{unb}	:	0.306	%	Unbalance rate
L_{oss1}	:	0.546k	W	Loss

±0.01 Hz* Basic Accuracy for Voltage Frequency Measurements

Perform the frequency measurements that are required for various PCS tests with industry-leading accuracy and stability. Take highly accurate frequency measurements on up to 4 channels simultaneously, while also measuring other parameters at the same time.

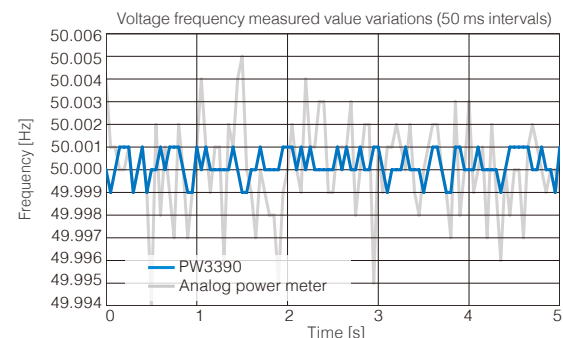

* If you require even higher accuracy for frequency, please inquire with your local Hioki distributor.

Test Automobile Fuel Economy

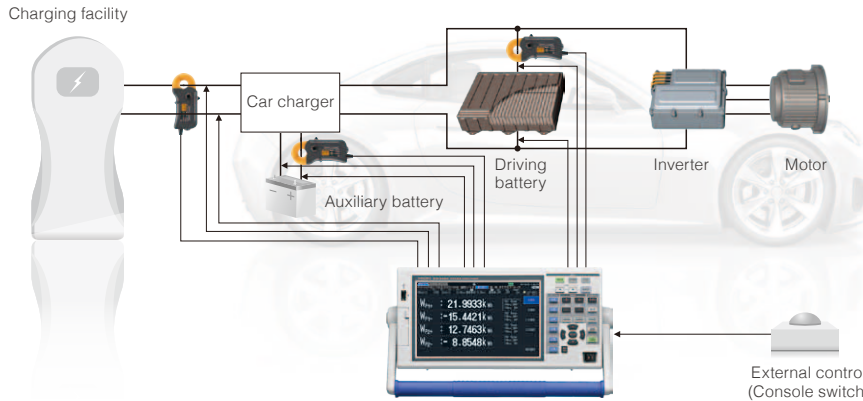

Key features

1. Accurately measure recharge and discharge power with excellent basic accuracy and DC accuracy.
2. 4 built-in channels, standard. Support for multiple recharge and discharge measurements, including auxiliary batteries.
3. Easily achieve highly accurate measurements with clamp sensors, which can be used in a wide range of operating temperatures.
4. Easily link with other measuring instruments through integration control with an external control interface.



Scan QR Code to Watch Video Illustrating Fuel Economy Evaluation of an Automobile

Evaluate WLTC Mode Performance - A New Fuel Economy Standard

Taking fuel economy measurements that comply with WLTP international standards requires the precise measurement of current integration and power integration for the recharging/discharging of each battery in the system. High accuracy clamp current sensors, the excellent DC accuracy of the PW3390, and the ability to integrate current and power at 50 ms intervals are extremely effective in meeting this application.

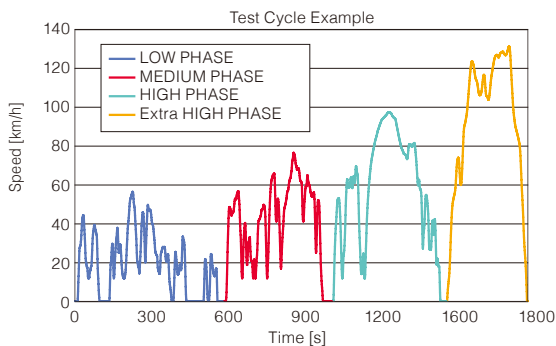

Optimal Current Sensors for Automotive Testing

Easily connect high accuracy clamp-type sensors without cutting the cables. Sensors operate over a temperature range of -40°C to 85°C (-40°F to 185°F), characteristics that enable highly accurate measurements even inside the engine room of a car.

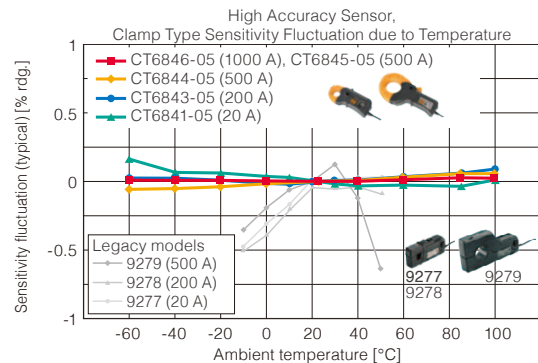

Current and Power Integration Function by Polarity

DC integration measurement integrates the recharging power and discharging power by polarity for every sample at 500 kS/s, and measures positive-direction power magnitude, negative-direction power magnitude, and the sum of positive- and negative-direction power magnitude during the integration period. Accurate measurement of recharging power and discharging power is possible even if there is rapid repetition of battery recharging/discharging.

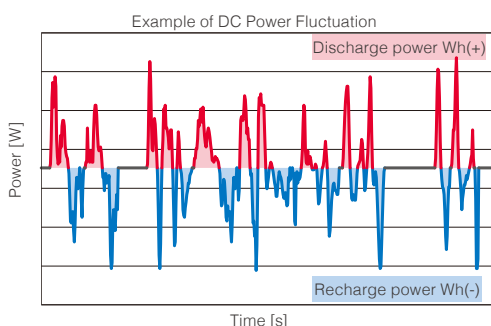

Link to Peripheral Devices via External Control

Use external control terminals to START/STOP integration and capture screen shots. This makes it easy to control operations from console switches and link to the timing of other instruments when measuring the performance of an actual automobile.

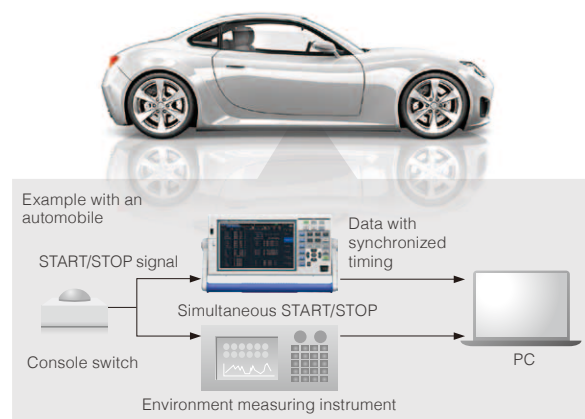

External Appearance

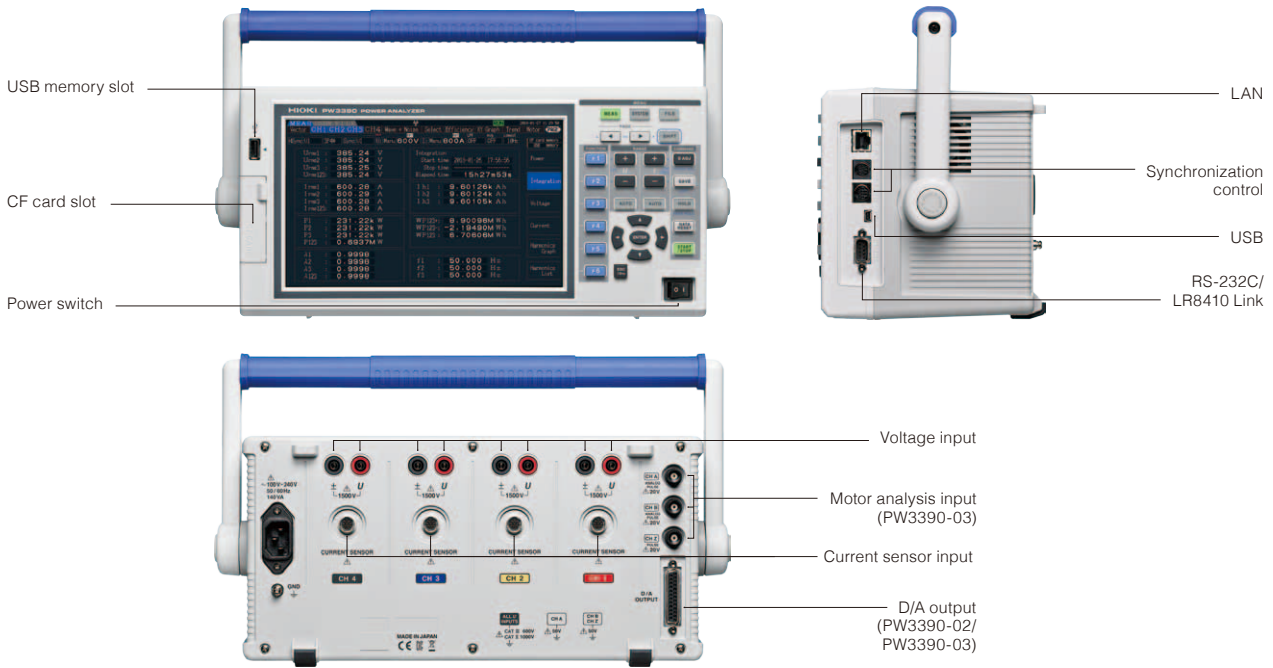

Software

Download software, drivers, and the Communications Command Instruction Manual from the Hioki website. <https://www.hioki.com>

PC Communication Software – PW Communicator

PC Communicator is a free application that connects to the PW3390 via a communications interface (LAN, RS-232C, or GP-IB), making it easy to configure the instrument's settings and to monitor or save measured values and waveform data from a computer. The software can simultaneously connect to up to 8 Hioki power measuring instruments, including the PW3390, Power Analyzer PW6001, Power Meter PW3335, PW3336, and PW3337, and it can provide integrated control over multiple models. The software can also be used to simultaneously save measurement data on the computer and calculate efficiency between instruments.

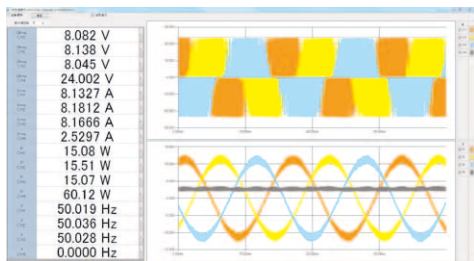

GENNECT One SF4000

The SF4000 is a free application software that lets you display and save measurement data on a PC in real-time after connecting the PW3390 to the PC via Ethernet.

The application is also compatible with other Hioki measuring instruments such as Memory HiLogger LR8450 and the Wireless Logging Station LR8410, letting you connect up to 15 units at the same time to monitor, graph and display lists of measured values from multiple instruments all at once and in real-time. This is especially effective for performing a total analysis of power, temperature and other factors of equipment.

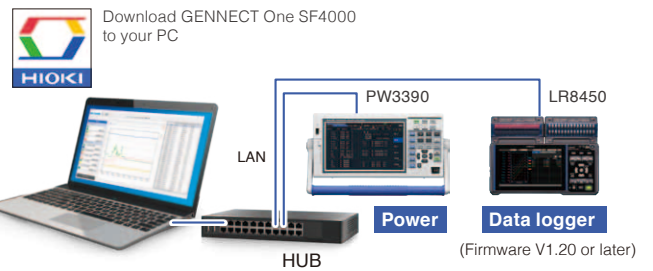

LabVIEW driver

Use the bundled LabVIEW driver to build a measurement system via a simple programming interface that lets you place icons on a window and connect them with lines. Multiple sample programs for configuring settings and downloading data are available, so you can get started right away.

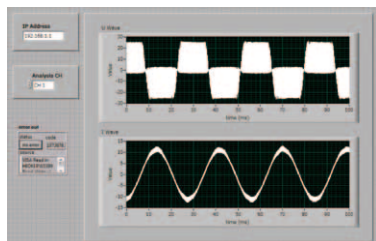

*LabVIEW is a registered trademark of National Instruments.

Remote control using a web browser

Use the PW3390's HTTP server function to connect to a computer via a LAN interface. You can configure settings or check data from a remote location using a virtual control panel that is displayed in the browser window.

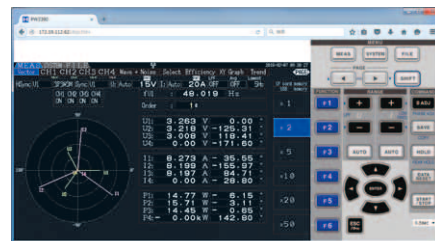

Specifications

Basic Specifications

Accuracy guaranteed for 6 months (and 1.25 times specified accuracy for one year)
Post-adjustment accuracy guaranteed for: 6 months

-1. Power Measurement Input Specifications

Measurement line type	Single-phase 2-wire (1P2W), Single-phase 3-wire (1P3W), 3-phase 3-wire (3P3W2M, 3P3W3M), 3-phase 4-wire (3P4W)			
	CH1	CH2	CH3	CH4
Pattern 1	1P2W	1P2W	1P2W	1P2W
Pattern 2	1P3W		1P2W	1P2W
Pattern 3	3P3W2M		1P2W	1P2W
Pattern 4	1P3W		1P3W	
Pattern 5	3P3W2M		1P3W	
Pattern 6	3P3W2M		3P3W2M	
Pattern 7	3P3W3M			1P2W
Pattern 8	3P4W			1P2W
Number of input channels	Voltage: 4 channels U1 to U4, Current: 4 channels I1 to I4			
Measurement input terminal type	Voltage: Plug-in jacks (safety jacks) Current: Dedicated custom connectors (ME15W)			
Input methods	Voltage: Isolated inputs, resistive dividers Current: Insulated current sensors (voltage output)			
Voltage range	15 V/30 V/60 V/150 V/300 V/600 V/1500 V (Selectable for each measured wiring system. AUTO range available.)			
Current range (): Sensor used	2 A/4 A/8 A/20 A (with the 9272-05, 20 A) 0.4 A/0.8 A/2 A/4 A/8 A/20 A (with the CT6841-05) 4 A/8 A/20 A/40 A/80 A/200 A (200 A sensor) 40 A/80 A/200 A/400 A/800 A/2 kA (2000 A sensor) 0.1 A/0.2 A/0.5 A/1 A/2 A/5 A (5 A sensor) 1 A/2 A/5 A/10 A/20 A/50 A (50 A sensor) 10 A/20 A/50 A/100 A/200 A/500 A (500 A sensor) 20 A/40 A/100 A/200 A/400 A/1 kA (1000 A sensor) 400 A/800 A/2 kA (CT7642 and CT7742) 400 A/800 A/2 kA/4 kA/8 kA (CT7044, CT7045, and CT7046) 400 A/800 A/2 kA/4 kA/8 kA/20 kA (100 uV/A sensor) 40 A/80 A/200 A/400 A/800 A/2 kA (1 mV/A sensor) 4 A/8 A/20 A/40 A/80 A/200 A (10 mV/A sensor) 0.4 A/0.8 A/2 A/4 A/8 A/20 A (100 mV/A sensor) (Selectable for each measured wiring system. AUTO range available.)			
Power range	1.5000 W to 90.00 MW: Determined automatically by the combination of voltage range, current range, and measurement line.			
Effective measuring range	Voltage, Current, Power: 1% to 110% of the range			
Total display area	Voltage, Current, Power: from zero-suppression range setting to 120%			
Zero-suppression ranges	Selectable OFF, 0.1 or 0.5% f.s. When OFF, non-zero values may be displayed even with no measurement input.			
Zero adjustment	Voltage: Zero-adjustment compensation of internal offset at or below ±10% f.s. Current: Zero-adjustment compensation of input offset at or below ±10% f.s. ±4 mV			
Waveform peak measurement range	Within ±300% of each voltage and current range			
Waveform peak measurement accuracy	Within ±2% f.s. of voltage and current display accuracy			
Crest factor	300 (relative to minimum effective voltage/current input) (for 1500 V range: 133) 3 (relative to voltage/current range rating) (for 1500 V range: 1.33)			
Input resistance (50 Hz/60 Hz)	Voltage input section : 2 MΩ ±40 kΩ (differential input and insulated input) Current sensor input section : 1 MΩ ±50 kΩ			
Maximum input voltage	Voltage input section : 1500 V, ±2000 Vpeak Current sensor input section : 5 V, ±10 Vpeak			
Maximum rated voltage to earth	Voltage input terminal 1000 V (50 Hz/60 Hz) Measurement categories III 600 V (anticipated transient overvoltage 6000 V) Measurement categories II 1000 V (anticipated transient overvoltage 6000 V)			
Measurement method	Simultaneous digital sampling of voltage and current, simultaneous zero-crossing calculation method			
Sampling	500 kHz/16 bit			
Measurement frequency range	DC, 0.5 Hz to 200 kHz			
Synchronization frequency range	0.5 Hz to 5 kHz Selectable lower limit measurement frequency (0.5 Hz/1 Hz/2 Hz/5 Hz/10 Hz/20 Hz)			
Synchronization source	U1 to U4, I1 to I4, Ext (with the motor evaluation installed model and CH B set for pulse input), DC (50 ms or 100 ms fixed) Selectable for each measurement channel (U/I for each channel measured using the same synchronization source) The zero-crossing filter automatically matches the digital LPF when U or I is selected. Two filter levels (strong or mild) Operation and accuracy are undetermined when the zero-crossing filter is disabled (off). Operation and accuracy are determined when U or I is selected and measured input is 30% f.s. or above.			
Data update interval	50 ms			
LPF	OFF/500 Hz/5 kHz/100 kHz (selectable for each wiring system) 500 Hz: Accuracy defined at 60 Hz or below (Add ±0.1% f.s.) 5 kHz: Accuracy defined at 500 Hz or below 100 kHz: Accuracy defined at 20 kHz or below (Add 1% rdg. at or above 10 kHz)			
Zero-crossing filter	Off, mild or strong			
Polarity discrimination	Voltage/current zero-crossing timing comparison method Zero-crossing filter provided by digital LPF			
Basic measurement parameters	Frequency, RMS voltage, voltage mean value, rectification RMS equivalent, voltage AC component, voltage simple average, voltage fundamental wave component, voltage waveform peak +, voltage waveform peak -, voltage total harmonic distortion, voltage ripple factor, voltage unbalance factor, RMS current, current mean value, rectification RMS equivalent, current AC component, current simple average, current fundamental wave component, current waveform peak +, current waveform peak -, current total harmonic distortion, current ripple factor, current unbalance factor, active power, apparent power, reactive power, power factor, voltage phase angle, current phase angle, power phase angle, positive-direction current magnitude, negative-direction current magnitude, sum of positive- and negative-direction current magnitude, positive-direction power magnitude, negative-direction power magnitude, sum of positive- and negative-direction power magnitude, efficiency, loss (PW3390-03) Motor torque, rpm, motor power, slip			
Voltage/current rectification method	Select which voltage and current values to use for calculating apparent and reactive power, and power factor RMS/MEAN (voltage and current in each phase system)			
Display resolution	99,999 counts (other than the integrated value) 999,999 counts (integrated value)			

Accuracy		Voltage (U)	Current (I)
	DC	±0.05% rdg. ±0.07% f.s.	±0.05% rdg. ±0.07% f.s.
	0.5 Hz ≤ f < 30 Hz	±0.05% rdg. ±0.1% f.s.	±0.05% rdg. ±0.1% f.s.
	30 Hz ≤ f < 45 Hz	±0.05% rdg. ±0.1% f.s.	±0.05% rdg. ±0.1% f.s.
	45 Hz ≤ f ≤ 66 Hz	±0.04% rdg. ±0.05% f.s.	±0.04% rdg. ±0.05% f.s.
	66 Hz < f ≤ 1 kHz	±0.1% rdg. ±0.1% f.s.	±0.1% rdg. ±0.1% f.s.
	1 kHz < f ≤ 10 kHz	±0.2% rdg. ±0.1% f.s.	±0.2% rdg. ±0.1% f.s.
	10 kHz < f ≤ 50 kHz	±0.3% rdg. ±0.2% f.s.	±0.3% rdg. ±0.2% f.s.
	50 kHz < f ≤ 100 kHz	±1.0% rdg. ±0.3% f.s.	±1.0% rdg. ±0.3% f.s.
	100 kHz < f ≤ 200 kHz	±20% f.s.	±20% f.s.
	Active power (P)	Phase difference	
DC	±0.05% rdg. ±0.07% f.s.	-	
0.5 Hz ≤ f < 30 Hz	±0.05% rdg. ±0.1% f.s.	±0.08°	
30 Hz ≤ f < 45 Hz	±0.05% rdg. ±0.1% f.s.	±0.08°	
45 Hz ≤ f ≤ 66 Hz	±0.04% rdg. ±0.05% f.s.	±0.08°	
66 Hz < f ≤ 1 kHz	±0.1% rdg. ±0.1% f.s.	±0.08°	
1 kHz < f ≤ 10 kHz	±0.2% rdg. ±0.1% f.s.	±(0.06°f+0.02)°	
10 kHz < f ≤ 50 kHz	±0.4% rdg. ±0.3% f.s.	±0.62°	
50 kHz < f ≤ 100 kHz	±1.5% rdg. ±0.5% f.s.	±(0.005°f+0.4)°	
100 kHz < f ≤ 200 kHz	±20% f.s.	±(0.022°f-1.3)°	
Values of f in above tables are given in kHz. Accuracy figures for DC voltage and current are defined for Udc and Idc, while accuracy figures for frequencies other than DC are defined for Urms and Irms. Accuracy figures for phase difference values are defined for full-scale input with a power factor of zero and the LPF disabled. Accuracy figures for voltage, current, and active power values in the frequency range of 0.5 Hz to 10 Hz are provided as reference values. Accuracy figures for voltage and active power values in excess of 220 V in the frequency range of 10 Hz to 16 Hz are provided as reference values. Accuracy figures for voltage and active power values in excess of 750 V in the frequency range of 30 kHz to 100 kHz are provided as reference values. Accuracy figures for voltage and active power values in excess of (22,000f/[kHz]) V in the frequency range of 100 kHz to 200 kHz are provided as reference values. Accuracy figures for voltage and active power values in excess of 1000 V are provided as reference values. Accuracy figures for phase difference values outside the frequency range of 45 Hz to 66 Hz are provided as reference values. For voltages in excess of 600 V, add the following to the phase difference accuracy: 500 Hz < f ≤ 5 kHz: ±0.3° 5 kHz < f ≤ 20 kHz: ±0.5° 20 kHz < f ≤ 200 kHz: ±1° Add ±20 μV to the DC current and active power accuracy (at 2 V f.s.)			
Add the current sensor accuracy to the above accuracy figures for current, active power, and phase difference. However, the combined accuracy is defined separately for the current measurement options listed below.			
When used with current measurement options PW9100-03 or PW9100-04, combined accuracy is defined as follows (with PW3390 range as f.s.):			
	Current (I)	Active power (P)	
DC	±0.07% rdg. ±0.077% f.s.	±0.07% rdg. ±0.077% f.s.	
45 Hz ≤ f ≤ 66 Hz	±0.06% rdg. ±0.055% f.s.	±0.06% rdg. ±0.055% f.s.	
Add ±0.12% f.s. (f.s. = PW3390 range) when using 1 A or 2 A range.			
When used in combination with Models CT6875, CT6876 or CT6877, the following specifications apply (f.s. refers to the PW3390's range)			
	Current (I)	Active power (P)	
DC	±0.09% rdg. ±0.078% f.s.	±0.09% rdg. ±0.078% f.s.	
45 Hz ≤ f ≤ 66 Hz	±0.08% rdg. ±0.058% f.s.	±0.08% rdg. ±0.058% f.s.	
CT6875: When using the 10A or 20A range, add ±0.2% f.s. (f.s. = PW3390 range) CT6876: When using the 20A or 40A range, add ±0.2% f.s. (f.s. = PW3390 range) CT6877: When using the 40A or 80A range, add ±0.2% f.s. (f.s. = PW3390 range)			
When used with any of the following current measurement options: special-order high-accuracy CT6862-05, or high-accuracy CT6863-05, combined accuracy is defined as follows (with PW3390 range as f.s.):			
	Current (I)	Active power (P)	
DC	±0.095% rdg. ±0.08% f.s.	±0.095% rdg. ±0.08% f.s.	
45 Hz ≤ f ≤ 66 Hz	±0.085% rdg. ±0.06% f.s.	±0.085% rdg. ±0.06% f.s.	
Apply LPF accuracy definitions to the above accuracy figures when using the LPF.			
Conditions of guaranteed accuracy	Temperature and humidity for guaranteed accuracy: 23°C ±3°C (73°F ±5°F), 80% R.H. or less Warm-up time: 30 min. or more Input: Within the specified ranges when the fundamental wave is synchronized with the sync source, for sine wave input, power factor of one, or DC input, zero ground voltage, within effective measurement range after zero-adjustment and within the range which the fundamental wave satisfies the synchronization source conditions		
Temperature coefficient	±0.01% f.s./°C (for DC, add ±0.01% f.s./°C)		
Effect of common mode voltage	±0.01% f.s. or less (with 1000 V @50 Hz/60 Hz applied between voltage measurement jacks and chassis)		
Magnetic field interference	±1% f.s. or less (in 400 A/m magnetic field, DC and 50 Hz/60 Hz)		
Power factor influence	Other than φ = ±90°: ±(1-cos(φ+Phase difference accuracy)/cos(φ)) ×100% rdg. When φ = ±90°: ±cos(φ+Phase difference accuracy) ×100% f.s.		
Susceptibility to conducted electromagnetic field	@3 V, current and active power not more than ±6% f.s., where f.s. current is the rated primary-side current of the current sensor f.s. active power equals the voltage range × the rated primary-side current of the current sensor		
Susceptibility to radiated electromagnetic field	@10 V/m, current and active power not more than ±6% f.s., where f.s. current is the rated primary-side current of the current sensor f.s. active power equals the voltage range × the rated primary-side current of the current sensor		
-2. Frequency Measurement Specifications			
Measurement channels	Four (f1 to f4)		
Measurement source	Select U/I for each measurement channel		
Measurement method	Reciprocal method + zero-crossing sample value correction		
Measuring range	Synchronous range from 0.5 Hz to 5 kHz (with "0.0000 Hz" or "----- Hz" unmeasurable time)		
Lower limit measurement frequency	0.5 Hz/1 Hz/2 Hz/5 Hz/10 Hz/20 Hz		
Data update interval	50 ms (measurement-frequency-dependent at 45 Hz and below)		
Accuracy	±0.01 Hz (during voltage frequency measurement within the range of 45 Hz to 66 Hz) ±0.05% rdg., ±1 dgt. (under other conditions) With sine wave of at least 30% of the measurement source's measurement range		
Numerical display format	0.5000 Hz to 9.9999 Hz, 9.900 Hz to 99.999 Hz, 99.00 Hz to 999.99 Hz, 0.9900 kHz to 5.0000 kHz		

-3. Integration Measurement Specifications

Measurement mode	Selectable between RMS or DC for each wiring mode
Measurement items	Current integration (Ih+, Ih-, and Ih), active power integration (WP+, WP-, and WP) Ih+ and Ih- only for DC mode measurements, and Ih only for RMS mode measurements
Measurement method	Digital calculation from each current and active power phase (when averaging, calculates with previous average value) In DC mode: calculates current value at every sample, and integrates instantaneous power independent of polarity In RMS mode: Integrates current effective values between measurement intervals, and polarity-independent active power value
Measurement interval	50 ms data update interval
Measuring range	Integration value: 0 Ah/Wh to ±9999.99 TAh/TWh Integration time: No greater than 9999h59m
Integration time accuracy	±50 ppm ±1 dgt. (0°C to 40°C (32°F to 104°F))
Integration accuracy	± (current and active power accuracy) ± integration time accuracy
Backup function	Integration automatically resumes after power outages.

-4. Harmonic Measurement Specifications

Number of measurement channels	4 channels Harmonic measurements not available for multiple systems with different frequencies.																											
Measurement items	Harmonic rms voltage, harmonic voltage percentage, harmonic voltage phase angle, harmonic rms current, harmonic current percentage, harmonic current phase angle, harmonic active power, harmonic power percentage, harmonic voltage-current phase difference, total harmonic voltage distortion, total harmonic current distortion, voltage unbalance factor, current unbalance factor																											
Measurement method	Zero-crossing synchronous calculation (all channels in same window), with gap Fixed 500 kS/s sampling, after digital anti-aliasing filter Equal thinning between zero crossings (with interpolation calculation)																											
Harmonic sync source	U1 to U4, I1 to I4, External (with motor analysis and CH B set for pulse input), DC selectable (50 ms or 100 ms)																											
FFT calculation word length	32 bits																											
Anti-aliasing filter	Digital filter (automatically set based on synchronization frequency)																											
Windows	Rectangular																											
Synchronization frequency range	As specified for power measurements																											
Data update interval	50 ms (measurement-frequency-dependent at 45 Hz and below)																											
Phase zero adjustment	Provided by key operation or external control command (only with external sync source) Automatic or manual configuration of phase zero-adjustment values Phase zero-adjustment setting range: 0.00° to ±180.00° (in 0.01° increments)																											
THD calculation	THD-F/THD-R																											
Highest order analysis and window waveforms	<table border="1"> <thead> <tr> <th>Synchronization frequency range</th> <th>Window waveforms</th> <th>Analysis order</th> </tr> </thead> <tbody> <tr> <td>0.5 Hz ≤ f < 40 Hz</td> <td>1</td> <td>100th</td> </tr> <tr> <td>40 Hz ≤ f < 80 Hz</td> <td>1</td> <td>100th</td> </tr> <tr> <td>80 Hz ≤ f < 160 Hz</td> <td>2</td> <td>80th</td> </tr> <tr> <td>160 Hz ≤ f < 320 Hz</td> <td>4</td> <td>40th</td> </tr> <tr> <td>320 Hz ≤ f < 640 Hz</td> <td>8</td> <td>20th</td> </tr> <tr> <td>640 Hz ≤ f < 1.2 kHz</td> <td>16</td> <td>10th</td> </tr> <tr> <td>1.2 kHz ≤ f < 2.5 kHz</td> <td>32</td> <td>5th</td> </tr> <tr> <td>2.5 kHz ≤ f < 5.0 kHz</td> <td>64</td> <td>3th</td> </tr> </tbody> </table>	Synchronization frequency range	Window waveforms	Analysis order	0.5 Hz ≤ f < 40 Hz	1	100th	40 Hz ≤ f < 80 Hz	1	100th	80 Hz ≤ f < 160 Hz	2	80th	160 Hz ≤ f < 320 Hz	4	40th	320 Hz ≤ f < 640 Hz	8	20th	640 Hz ≤ f < 1.2 kHz	16	10th	1.2 kHz ≤ f < 2.5 kHz	32	5th	2.5 kHz ≤ f < 5.0 kHz	64	3th
Synchronization frequency range	Window waveforms	Analysis order																										
0.5 Hz ≤ f < 40 Hz	1	100th																										
40 Hz ≤ f < 80 Hz	1	100th																										
80 Hz ≤ f < 160 Hz	2	80th																										
160 Hz ≤ f < 320 Hz	4	40th																										
320 Hz ≤ f < 640 Hz	8	20th																										
640 Hz ≤ f < 1.2 kHz	16	10th																										
1.2 kHz ≤ f < 2.5 kHz	32	5th																										
2.5 kHz ≤ f < 5.0 kHz	64	3th																										
Accuracy	<table border="1"> <thead> <tr> <th>Frequency</th> <th>Voltage(U), Current(I), Active Power(P)</th> </tr> </thead> <tbody> <tr> <td>0.5 Hz ≤ f < 30 Hz</td> <td>±0.4% rdg. ±0.2% f.s.</td> </tr> <tr> <td>30 Hz ≤ f < 400 Hz</td> <td>±0.3% rdg. ±0.1% f.s.</td> </tr> <tr> <td>400 Hz < f ≤ 1 kHz</td> <td>±0.4% rdg. ±0.2% f.s.</td> </tr> <tr> <td>1 kHz < f ≤ 5 kHz</td> <td>±1.0% rdg. ±0.5% f.s.</td> </tr> <tr> <td>5 kHz < f ≤ 10 kHz</td> <td>±2.0% rdg. ±1.0% f.s.</td> </tr> <tr> <td>10 kHz < f ≤ 13 kHz</td> <td>±5.0% rdg. ±1.0% f.s.</td> </tr> </tbody> </table> <p>Not specified for sync frequencies of 4.3 kHz and higher Add the LPF accuracy to the above when using LPF.</p>	Frequency	Voltage(U), Current(I), Active Power(P)	0.5 Hz ≤ f < 30 Hz	±0.4% rdg. ±0.2% f.s.	30 Hz ≤ f < 400 Hz	±0.3% rdg. ±0.1% f.s.	400 Hz < f ≤ 1 kHz	±0.4% rdg. ±0.2% f.s.	1 kHz < f ≤ 5 kHz	±1.0% rdg. ±0.5% f.s.	5 kHz < f ≤ 10 kHz	±2.0% rdg. ±1.0% f.s.	10 kHz < f ≤ 13 kHz	±5.0% rdg. ±1.0% f.s.													
Frequency	Voltage(U), Current(I), Active Power(P)																											
0.5 Hz ≤ f < 30 Hz	±0.4% rdg. ±0.2% f.s.																											
30 Hz ≤ f < 400 Hz	±0.3% rdg. ±0.1% f.s.																											
400 Hz < f ≤ 1 kHz	±0.4% rdg. ±0.2% f.s.																											
1 kHz < f ≤ 5 kHz	±1.0% rdg. ±0.5% f.s.																											
5 kHz < f ≤ 10 kHz	±2.0% rdg. ±1.0% f.s.																											
10 kHz < f ≤ 13 kHz	±5.0% rdg. ±1.0% f.s.																											

-5. Noise Measurement Specifications

Calculation channels	1 (Select one from CH1 to CH4)
Calculation items	Voltage noise/Current noise
Calculation type	RMS spectrum
Calculation method	Fixed 500 kS/s sampling, thinning after digital anti-aliasing filter
FFT calculation word length	32 bits
FFT data points	1000/5000/10,000/50,000 (according to displayed waveform recording length)
Anti-aliasing filter	Automatic digital filter (varies with maximum analysis frequency)
Windows	Rectangular/Hanning/flat-top
Data update interval	Determined by FFT points within approx. 400 ms, 1 s, 2 s, or 15 s, with gap
Highest analysis frequency	200 kHz/50 kHz/20 kHz/10 kHz/5 kHz/2 kHz
Frequency resolution	0.2 Hz to 500 Hz (Determined by FFT points and maximum analysis frequency)
Noise amplitude measurement	Calculates the ten highest level and frequency voltage and current FFT peak values (local maxima).
Lower limit noise frequency	0 kHz to 10 kHz

-6. Motor Analysis Specifications (Model PW3390-03)

Number of input channels	3 channels CH A: Analog DC input/Frequency input (selectable) CH B: Analog DC input/Pulse input (selectable) CH Z: Pulse input
Measurement input terminal type	Insulated BNC jacks
Input impedance (DC)	1 MΩ ±100 kΩ
Input methods	Isolated and differential inputs (not isolated between channels B and Z)
Measurement items	Voltage, torque, rotation rate, frequency, slip, and motor power
Synchronization source	U1 to U4, I1 to I4, Ext (with CH B set for pulse input), DC (50 ms/100 ms) Common to channels A and B
Measurement frequency source	f1 to f4 (for slip calculations)
Maximum input voltage	±20 V (during analog, frequency, and pulse input)
Maximum rated voltage to earth	50 V (50 Hz/60 Hz)

(1). Analog DC Input (CH A/CH B)

Measurement range	±1 V, ±5 V, ±10 V (when inputting analog DC)
Valid input range	1% to 110% f.s.
Sampling	10 kHz/16 bits
Response time	1 ms (measuring zero to full scale, with LPF off)
Measurement method	Simultaneous digital sampling and zero-crossing synchronous calculation system (cumulative average of intervals between zero crossings)
Measurement accuracy	±0.08% rdg. ±0.1% f.s.
Temperature coefficient	±0.03% f.s./°C
Effect of common mode voltage	Not more than ±0.01% f.s. (with 50 V [DC or 50 Hz/60 Hz] between measurement jacks and PW3390 chassis)

Effect of external magnetic field	Not more than ±0.1% f.s. (at 400 A/m DC and 50 Hz/60 Hz magnetic fields)
LPF	OFF/ON (OFF: 4 kHz, ON: 1 kHz)
Total display area	Zero-suppression range setting ±120%
Zero adjustment	Zero-corrected input offset of voltage ±10% f.s. or less
Scaling	0.01 ~ 9999.99
Unit	CH A: V, N, m, mN, m, kN, m, CH B: V, Hz, r/min

(2). Frequency Input (CH A only)

Valid amplitude range	±5 V peak (5 V symmetrical, equivalent to RS-422 complementary signal)
Max. measurement frequency	100 kHz
Measurement range	1 kHz to 100 kHz
Data output interval	According to synchronization source
Measurement accuracy	±0.05% rdg., ±3 dgt.
Total display area	1,000 kHz to 99,999 kHz
Frequency range	Select fc and fd for frequency range fc ± fd [Hz] (frequency measurement only) 1 kHz to 98 kHz in 1 kHz units, where fc + fd < 100 kHz and fc - fd > 1 kHz
Rated torque	1 ~ 999
Unit	Hz, N, m, mN, m, kN, m

(3). Pulse Input (CH B only)

Detection level	Low: 0.5 V or less; High: 2.0 V or more
Measurement range	1 Hz to 200 kHz (at 50% duty)
Division setting range	1 ~ 60000
Measurement frequency range	0.5 Hz to 5.0 kHz (limited to measured pulse frequency divided by selected no. of divisions)
Minimum detectable pulse width	2.5 μs or more
Measurement accuracy	±0.05% rdg., ±3 dgt.
Motor poles	2 ~ 98
Max. measurement frequency	100 Hz, 500 Hz, 1 kHz, 5 kHz
Pulse count	Integer multiple of half the number of motor poles, from 1 to 60,000
Unit	Hz, r/min

(4). Pulse Input (CH Z only)

Detection level	Low: 0.5 V or less; High: 2.0 V or more
Measurement range	0.1 Hz to 200 kHz (at 50% duty)
Minimum detectable pulse width	2.5 μs or more
Settings	OFF/Z Phase/B Phase (clear counts of CHB in rising edge during Z Phase, detect polar code for number of rotations during B Phase)

-7. D/A Output Option Specifications (Models PW3390-02 and PW3390-03)

Number of output channels	16 channels
Output contents	CH1 to CH8: Selectable analog/waveform outputs CH9 to CH16: Analog output
Output items	Analog output: Select a basic measurement item for each output channel. Waveform output: Output voltage or current measured waveforms.
Output connector	One 25-pin female D-sub
D/A conversion resolution	16 bits (polarity + 15 bits)
Output accuracy	Analog output: Measurement accuracy ±0.2% f.s. (DC level) Waveform output: Measurement accuracy ±0.5% f.s. (at ±2 V f.s.), ±1.0% f.s. (at ±1 V f.s.) (rms level within synchronous frequency range)
Output update interval	Analog output: 50 ms (according to input data update interval of selected parameter) Waveform output: 500 kHz
Output voltage	Analog output: ±5 V DC nom. (approx. ±12 V DC max.) Waveform output: ±2 V/±1 V switchable, crest factor of 2.5 or greater Setting applies to all channels.
Output impedance	100 Ω ±5 Ω
Temperature coefficient	±0.05% f.s./°C

-8. Display Specifications

Display type	9-inch TFT color LCD (800×480 dots)
Display refresh interval	Measurement values: 200 ms (independent of internal data update interval) Waveforms, FFT: screen-dependent

-9. External Interface Specifications

(1). USB Interface (Functions)

Connector	Mini-B receptacle x1
Compliance standard	USB2.0 (Full Speed/High Speed)
Class	Individual (USB488h)
Connection destination	Computer (Windows10/Windows8/Windows7, 32bit/64bit)
Function	Data transfer and command control

(2). USB Memory Interface

Connector	USB type A connector x1
Compliance standard	USB2.0
USB power supply	500 mA maximum
USB storage device support	USB Mass Storage Class
Function	Save and load settings files, Save waveform data Save displayed measurement values (CSV format) Copy measurement values and recorded data (from CF card) Save waveform data Save FFT spectrum for noise measurement Save/load screenshots

(3). LAN Interface

Connector	RJ-45 connector x 1
Compliance standard	IEEE 802.3 compliant
Transmission method	10BASE-T/100BASE-TX Auto detected
Protocol	TCP/IP
Function	HTTP server (remote operation), Dedicated port (data transfer and command control)
Maximum cable length	Up to 3 m

(4). CF Card Interface

Slot	One Type 1
Compatible card	CompactFlash memory card (32 MB or higher)
Supported memory capacity	Up to 2 GB
Data format	MS-DOS format (FAT16/FAT32)
Recordable content	Save and load settings files, Save waveform data Save displayed measurement values and auto-recorded data (CSV format) Copy measurements/recorded data (from USB storage) Save waveform data Save FFT spectrum for noise waveforms Save/load screenshots

(5). RS-232C Interface

Method	RS-232C, [EIA RS-232D], [CCITT V.24], [JIS X5101] compliant Full duplex, start-stop synchronization, 8-bit data, no parity, one stop bit Hardware flow control, CR+LF delimiter
Connector	D-sub9 pin connector x1
Communication speeds	9600 bps, 19,200 bps, 38,400 bps
Function	Command control, Bluetooth® logger connectivity (simultaneous use not supported)

(6). Synchronization Control Interface

Signal contents	One-second clock, integration START/STOP, DATA RESET, EVENT
Connector types	IN: One 9-pin female mini-DIN jack, OUT: One 8-pin female mini-DIN jack
Signal	5 V CMOS
Max. input	±20 V
Max. signal delay	2 μs (rising edge)

(7). External Control Interface

Connector types	9-pin round connector x1; also used as synchronization control interface
Electrical specifications	Logic signal of 0 V/5 V (2.5 V to 5 V), or contact signal (shorted/open)
Function	Integration start, integration stop, data reset, event (the event set as the synchronization control function) Cannot be used at the same time as synchronization control.

Function Specifications

-1. Control Functions

AUTO range function	Automatically selects voltage and current ranges according to measured amplitude on each phase. Operating states: Selectable on or off for each phase system Auto-ranging span: Wide/Narrow (common to all wiring systems)
Timing control function	Interval OFF/50 ms/100 ms/200 ms/500 ms/1 s/5 s/10 s/ 15 s/30 s/1 min/5 min/10 min/15 min/30 min/60 min Setting determines the maximum data-saving capacity Timing controls OFF/Timer/RTC Timer : 10 s to 9999:59:59 [h:m:s] (in seconds) Real-time clock : Start and stop times (in minutes)
Hold function	Stops all updating of displayed measurement values and waveforms, and holds display. Internal calculations such as integration and averaging, clock, and peak-over display continue to be updated.
Peak hold function	All measurement values are updated to display the maximum value for each measurement. Displayed waveforms and integration values continue to be updated with instantaneous values.

-2. Calculation Functions

Scaling calculation	VT(PT) ratio and CT ratio: OFF/0.01 to 9999.99
Average calculation	OFF/FAST/MID/SLOW/SLOW2/SLOW3 Exponentially averages all instantaneous measurement values including harmonics (but not peak, integration, or FFT noise values). Applied to displayed values and saved data. Response speed (time remains within specified accuracy when input changes from 0 to 100% f.s.) FAST: 0.2 s, MID: 1.0 s, SLOW: 5 s, SLOW2: 25 s, SLOW3: 100 s
Efficiency and loss calculations	Efficiency η [%] and Loss [W] are calculated from active power values measured on each phase and system. For PW3390-03, motor power (Pm) is also applied as a calculation item. Maximum no. of simultaneous calculations: Efficiency and loss, by three formulas (Parameters are specified for Pin and Pout) Calculation method: $Efficiency\ \eta = 100 \times IPout/IPin$ $Loss = IPin - IPout$
Δ-V calculation	For 3P3W3M systems, converts between line-to-line voltage and phase voltage waveforms using a virtual center point. All voltage parameters including harmonics such as true rms voltage are calculated as phase voltage waveforms. $U1s = (U1s-U3s)/3$, $U2s = (U2s-U1s)/3$, $U3s = (U3s-U2s)/3$
Selecting the calculation method	TYPE1/TYPE2 (only valid when wiring is 3P3W3M) Select the calculation method used to calculate the apparent power and reactive power during 3P3W3M wiring. Only affect measurement values S123, Q123, φ123, λ123
Current sensor phase correction calculations	Compensation by calculating the current sensor's harmonic phase characteristics Correction points are set using frequency and phase difference (set separately for each wiring mode). Frequency: 0.001 kHz to 999.999 kHz (in 0.001 kHz increments) Phase difference: 0.00 ° to ±90.00 ° (in 0.01 ° increments) However, the time difference calculated from the frequency phase difference is limited to a maximum of 200 us in 5 ns increments.

-3. Display Functions

Wiring Check screen	The wiring diagram and voltage/current vectors are displayed for the selected wiring system(s). The correct range for the wiring system is shown on the vector display, to confirm proper measurement cable connections.																																			
Independent wiring system display mode	Displays power and harmonic measurement values for channels 1 to 4. A composite measurement line pattern is displayed for each system. Basic, voltage, current, and power measurement parameter, harmonic bar graph, harmonic list, and harmonic vector screens																																			
Display Selections screen	Select to display any 4, 8, 16, or 32 of the basic measurement parameters. Display layout: 4, 8, 16, or 32 parameters (4 patterns)																																			
Efficiency and Loss screen	The efficiency and loss obtained by the specified calculation formulas are displayed numerically. Three efficiency and three loss values.																																			
Waveform & Noise screen	Voltage and current waveforms sampled at 500 kHz and noise measurements are displayed compressed on one screen. Trigger: Synchronized with the harmonic sync source Recording length: 1000/5000/10,000/50,000 x All voltage and current channels Compression ratio: 1/1, 1/2, 1/5, 1/10, 1/20, 1/50 (peak-to-peak compression) Recording time:																																			
	<table border="1"> <tr> <td>Recording speed/Recording length</td> <td>1000</td> <td>5000</td> <td>10,000</td> <td>50,000</td> </tr> <tr> <td>500 kS/s</td> <td>2 ms</td> <td>10 ms</td> <td>20 ms</td> <td>100 ms</td> </tr> <tr> <td>250 kS/s</td> <td>4 ms</td> <td>20 ms</td> <td>40 ms</td> <td>200 ms</td> </tr> <tr> <td>100 kS/s</td> <td>10 ms</td> <td>50 ms</td> <td>100 ms</td> <td>500 ms</td> </tr> <tr> <td>50 kS/s</td> <td>20 ms</td> <td>100 ms</td> <td>200 ms</td> <td>1000 ms</td> </tr> <tr> <td>25 kS/s</td> <td>40 ms</td> <td>200 ms</td> <td>400 ms</td> <td>2000 ms</td> </tr> <tr> <td>10 kS/s</td> <td>100 ms</td> <td>500 ms</td> <td>1000 ms</td> <td>5000 ms</td> </tr> </table>	Recording speed/Recording length	1000	5000	10,000	50,000	500 kS/s	2 ms	10 ms	20 ms	100 ms	250 kS/s	4 ms	20 ms	40 ms	200 ms	100 kS/s	10 ms	50 ms	100 ms	500 ms	50 kS/s	20 ms	100 ms	200 ms	1000 ms	25 kS/s	40 ms	200 ms	400 ms	2000 ms	10 kS/s	100 ms	500 ms	1000 ms	5000 ms
Recording speed/Recording length	1000	5000	10,000	50,000																																
500 kS/s	2 ms	10 ms	20 ms	100 ms																																
250 kS/s	4 ms	20 ms	40 ms	200 ms																																
100 kS/s	10 ms	50 ms	100 ms	500 ms																																
50 kS/s	20 ms	100 ms	200 ms	1000 ms																																
25 kS/s	40 ms	200 ms	400 ms	2000 ms																																
10 kS/s	100 ms	500 ms	1000 ms	5000 ms																																

Trend screen	Display a time-sequence graph of measured values for basic measurement parameters that have been selected as trend display parameters. Waveforms are graphed using peak-peak compression of data refresh rate data based on the time axis setting. Data is not stored. Number of graphed parameters: Up to 8 Time axis: 1.5 / 3 / 6 / 12 / 30 s/div.; 1 / 3 / 6 / 10 / 30 min./div.; 1 / 3 / 6 / 12 hour/div.; 1 day/div. Vertical axis: Auto (configured so that the data in the screen display range fits on the screen) / semi-auto (user selects the zoom factor relative to the full-scale values for graphed parameters from the following: 1/8, 1/4, 1/2, x1, x2, x5, x10, x50, x100, x200, x500) /manual (user sets the maximum and minimum values for the display)
X-Y Plot screen	Select horizontal and vertical axes from the basic measurement items to display on the X-Y graphs. Dots are plotted at the data update interval, and are not saved. Drawing data can be cleared. Horizontal: 1 data item (gauge display available), Vertical: 2 data items (gauge display available)

-4. Saving Functions

Auto-save function	As the items to be saved, select any measured values including harmonics and noise value data of the FFT function. The selected items are stored to CF card during every measurement interval. (Storage to USB memory is not available.) Can be controlled by timer or real-time clock. Max. no. of saved items: Interval-setting-dependent Data format: CSV format
Manual saving function	Save destinations: USB memory/CF card <ul style="list-style-type: none"> Measurement data As the items to be saved, select any measured values including harmonics and noise value data of the FFT function. Pressing the SAVE key saves each measurement value at that moment to the save destination. File format: CSV format Screen capture The COPY key captures and saves a bitmap image of the display to the save destination. *This function can be used at an interval of 5 sec or more while automatic saving is in progress. File format: Compressed BMP format Settings data Settings information can be saved/loaded as a settings file. File format: SET format (for PW3390 only) Waveform data Saves the waveform being displayed by means of [Wave/Noise] display. File format: CSV format FFT data Save the noise measurement FFT spectrum shown on the Waveform/Noise screen. File format: CSV format

-5. Synchronous Control Function

Function	Synchronous measurements are available by using sync cables to connect Model PW3390 (master/slave). When internal settings match, auto-save is available while synchronized.
Synchronized items	Clock, data update interval (except for FFT calculations), integration start/stop, data reset, certain events
Event items	Hold, manual save, screen capture
Synchronization timing	• Clock, data update interval Within 10 s after power-on by a slave PW3390 • Start/stop, data reset, event Upon key-press and communications operations on the master PW3390
Synchronization delay	Maximum 5 μs per connection. Maximum synchronization delay of an event is +50 ms

-6. Bluetooth® Logger Connectivity

Function	Sends measured values wirelessly to logger by using a Bluetooth® serial conversion adapter.
Supported devices	Hicoki LR8410 Link-compatible loggers (LR8410, LR8416)
Sent data	Measured values assigned to the D/A CH9 to CH16 analog output parameters

-7. Other Functions

Display language selection	Japanese, English, Chinese
Beep sound	OFF/ON
Screen color schemes	COLOR1 (black)/2 (blue-green)/3 (blue)/4 (gray)/5 (navy blue)
Start-up screen selection	Wiring or Last-displayed screen (Measurement screens only)
LCD backlight	ON/1 min/5 min/10 min/30 min/60 min
CSV file format	CSV/SSV
Real-time clock function	Auto-calendar, leap-year correcting 24-hour clock
RTC accuracy	±3 s per day @25°C (77°F)
Sensor recognition	Current sensors are automatically recognized when connected (Excluding the CT7000 series sensors)
Warning indicators	When peak over occurs on voltage and current measurement channels, When no sync source is detected Warning indicators for all channels are displayed on all pages of the MEAS screen.
Key-lock	Toggles on/off by holding the ESC key for three seconds.
System reset	Returns all settings to factory defaults
Power-on reset	Returns all settings including language and communications settings, to factory defaults.
File operations	Media content list display, format media, create folders, delete files and folders, copy between storage media

General Specifications

Operating environment	Indoors, Pollution Degree 2, altitude up to 2000 m (6562.20 ft)
Operating temperature and humidity	Temperature: 0°C to 40°C (32°F to 104°F), Humidity: 80% RH or less (no condensation)
Storage temperature and humidity	-10°C to 50°C (14°F to 122°F), 80% RH or less (no condensation)
Dustproof and waterproof	IP30 (EN 60529) (With CF card cover open: IP20)
Applicable standards	Safety EN 61010 EMC EN 61326 Class A
Power supply	100 V to 240 V AC, 50 Hz/60 Hz, Maximum rated power: 140 VA Anticipated transient overvoltage: 2500 V
Backup battery life	Clock, settings and integration values (Lithium battery), Approx. 10 years, @23°C (73°F)
Dimensions	340 mm (13.39 in) W x 170 mm (6.69 in) H x 156 mm (6.14 in) D (excluding protrusions)
Mass	4.6 kg (162.3 oz) with PW3390-03
Product warranty period	3 year
Accessories	Instruction Manual x1, Measurement Guide x1, Power cord x1, USB cable (0.9 m (2.95 ft)) x1, Input cord label x2, D-sub connector x1 (PW3390-02, PW3390-03)

High Accuracy Sensor, Pass-Through Type

Model	AC/DC CURRENT SENSOR CT6862-05	AC/DC CURRENT SENSOR CT6863-05	AC/DC CURRENT SENSOR CT6875, CT6875-01**	AC/DC CURRENT SENSOR CT6876, CT6876-01**	AC/DC CURRENT SENSOR CT6877, CT6877-01**
Appearance			NEW	NEW	NEW
Rated current	50 A AC/DC	200 A AC/DC	500 A AC/DC	1000 A AC/DC	2000 A AC/DC
Frequency band	DC to 1 MHz	DC to 500 kHz	DC to 2 MHz, DC to 1.5 MHz *1	DC to 1.5 MHz, DC to 1.2 MHz *1	DC to 1 MHz
Diameter of measurable conductors	Max. φ 24mm (0.94")	Max. φ 24 mm (0.94")	Max. φ 36 mm (1.42")	Max. φ 36 mm (1.42")	Max. φ 80 mm (3.15")
Basic accuracy	±0.05 % rdg. ±0.01 % f.s. (amplitude) ±0.2° (phase, not defined for DC) (At DC and 16 Hz to 400 Hz)	±0.05 % rdg. ±0.01 % f.s. (amplitude) ±0.2° (phase, not defined for DC) (At DC and 16 Hz to 400 Hz)	±0.04 % rdg. ±0.008 % f.s. (amplitude) ±0.1° (phase, not defined for DC) (At DC and 45 Hz to 66 Hz)	±0.04 % rdg. ±0.008 % f.s. (amplitude) ±0.1° (phase, not defined for DC) (At DC and 45 Hz to 66 Hz)	±0.04 % rdg. ±0.008 % f.s. (amplitude) ±0.1° (phase, not defined for DC) (At DC and 45 Hz to 66 Hz)
Frequency characteristics (Amplitude)	to 16 Hz: ±0.1% rdg. ±0.02% f.s. 400Hz to 1kHz: ±0.2% rdg. ±0.02% f.s. to 50 kHz: ±1.0% rdg. ±0.02% f.s. to 100 kHz: ±2.0% rdg. ±0.05% f.s. to 1 MHz: ±30% rdg. ±0.05% f.s.	to 16 Hz: ±0.1% rdg. ±0.02% f.s. 400Hz to 1kHz: ±0.2% rdg. ±0.02% f.s. to 10 kHz: ±1.0% rdg. ±0.02% f.s. to 100 kHz: ±5.0% rdg. ±0.05% f.s. to 500 kHz: ±30% rdg. ±0.05% f.s.	to 16 Hz: ±0.1% rdg. ±0.02% f.s. 16 Hz to 45 Hz: ±0.05% rdg. ±0.01% f.s. to 1 kHz: ±0.2% rdg. ±0.02% f.s. to 10 kHz: ±0.4% rdg. ±0.02% f.s. to 100 kHz: ±2.5% rdg. ±0.05% f.s. *1 to 1 MHz: ±(0.025x f kHz)% rdg. ±0.05% f.s.	to 16 Hz: ±0.1% rdg. ±0.02% f.s. 16 Hz to 45 Hz: ±0.05% rdg. ±0.01% f.s. to 1 kHz: ±0.2% rdg. ±0.02% f.s. to 10 kHz: ±0.5% rdg. ±0.02% f.s. to 100 kHz: ±3% rdg. ±0.05% f.s. *1 to 1 MHz: ±(0.03x f kHz)% rdg. ±0.05% f.s.	to 16 Hz: ±0.1% rdg. ±0.02% f.s. 16 Hz to 45 Hz: ±0.05% rdg. ±0.01% f.s. to 1 kHz: ±0.2% rdg. ±0.02% f.s. to 10 kHz: ±0.5% rdg. ±0.02% f.s. to 100 kHz: ±2.5% rdg. ±0.05% f.s. *1 to 700 kHz: ±(0.025x f kHz)% rdg. ±0.05% f.s.
Operating Temperature	-30°C to 85°C (-22°F to 185°F)	-30°C to 85°C (-22°F to 185°F)	-40°C to 85°C (-40°F to 185°F)	-40°C to 85°C (-40°F to 185°F)	-40°C to 85°C (-40°F to 185°F)
Effect of conductor position	Within ±0.01% rdg. (50 A, DC to 100 Hz)	Within ±0.01% rdg. (100 A, DC to 100 Hz)	Within ±0.01% rdg. (100 A, DC, 50 Hz/60 Hz)	Within ±0.01% rdg. (100 A, DC, 50 Hz/60 Hz)	Within ±0.01% rdg. (100 A, DC, 50 Hz/60 Hz)
Effect of external magnetic fields	10 mA equivalent or lower (400 A/m, 60 Hz and DC)	50 mA equivalent or lower (400 A/m, 60 Hz and DC)	20 mA equivalent or lower (400 A/m, 60 Hz and DC)	40 mA equivalent or lower (400 A/m, 60 Hz and DC)	80 mA equivalent or lower (400 A/m, 60 Hz and DC)
Maximum rated voltage to earth	CAT III 1000 V rms	CAT III 1000 V rms	CAT III 1000 V rms	CAT III 1000 V rms	CAT III 1000 V rms
Dimensions	70W (2.76") x 100H (3.94") x 53D (2.09") mm Cable length: 3 m (9.84 ft)	70W (2.76") x 100H (3.94") x 53D (2.09") mm Cable length: 3 m (9.84 ft)	160W (6.30") x 112H (4.41") x 50D (1.97") mm Cable length [CT6875: 3 m (9.84 ft), CT6875-01: 10 m (32.81 ft)]	160W (6.30") x 112H (4.41") x 50D (1.97") mm Cable length [CT6876: 3 m (9.84 ft), CT6876-01: 10 m (32.81 ft)]	229W (9.02") x 232H (9.13") x 112D (4.41") mm Cable length [CT6877: 3 m (9.84 ft), CT6877-01: 10 m (32.81 ft)]
Mass	340 g (12.0 oz.)	350 g (12.3 oz.)	850 g (30.0 oz.), 1100 g (38.8 oz.) *1	950 g (35.5 oz.), 1250 g (44.1 oz.) *1	5 kg (176.4oz), 5.3 kg (186.9 oz.) *1
Derating properties					

Custom cable lengths also available. Please inquire with your Hioki distributor.

*1: Models CT6875-01, CT6876-01 and CT6877-01 have 10m cable lengths. When using these sensors, please add ±(0.005x f kHz)% rdg. to the amplitude accuracy and ±(0.015x f kHz)° to the phase accuracy for frequency bandwidth 1 kHz < f ≤ 1MHz (1kHz < f ≤ 700kHz for the CT6877-01).

High Accuracy Sensor, Clamp Type

	AC/DC CURRENT SENSOR CT6865-05
External Appearance	Ultra-high accuracy Wideband 4 MHz
Rated current	500 A AC/DC
Frequency band	DC to 4 MHz
Diameter of measurable conductors	φ 32 mm (1.26 in) or less
Basic accuracy	For 45 Hz to 65 Hz Amplitude: ±0.02% rdg. ±0.007% f.s. Phase: ±0.08° For DC Amplitude: ±0.025% rdg. ±0.007% f.s.
Frequency characteristics (Amplitude)	to 16 Hz: ±0.2% rdg. ±0.02% f.s. 65 Hz to 850 Hz: ±0.05% rdg. ±0.007% f.s. to 10 kHz: ±0.4% rdg. ±0.02% f.s. to 300 kHz: ±2.0% rdg. ±0.05% f.s. to 1 MHz: ±5.0% rdg. ±0.05% f.s. 4 MHz: ±3dB Typical
Operating temperature range	-10°C to 50°C (14°F to 122°F)
Effect of conductor position	±0.01% rdg. or less (50/60 Hz)
Effects of external magnetic fields	In 400 A/m magnetic field (DC and 60 Hz) 50 mA or less
Maximum rated voltage to ground	CAT III 1000 V
Output connector	HIOKI ME15W
Dimensions	139 mm (5.47 in) W x 120 mm (4.72 in) H x 52 mm (2.05 in) D, Cable length: 3 m (9.84 ft)
Mass	Approx. 1.0 kg (35.3 oz)
Derating Characteristics	

	AC/DC CURRENT PROBE CT6841-05	AC/DC CURRENT PROBE CT6843-05	AC/DC CURRENT PROBE CT6844-05
External Appearance			
Rated current	20 A AC/DC	200 A AC/DC	500 A AC/DC
Frequency band	DC to 1 MHz	DC to 500 kHz	DC to 200 kHz
Diameter of measurable conductors	φ 20 mm (0.79 in) or less (insulated conductor)	φ 20 mm (0.79 in) or less (insulated conductor)	φ 20 mm (0.79 in) or less (insulated conductor)
Basic accuracy	For DC < f ≤ 100 Hz Amplitude: ±0.3% rdg. ±0.01% f.s. Phase: ±0.1° For DC Amplitude: ±0.3% rdg. ±0.05% f.s.	For DC < f ≤ 100 Hz Amplitude: ±0.3% rdg. ±0.01% f.s. Phase: ±0.1° For DC Amplitude: ±0.3% rdg. ±0.02% f.s.	For DC < f ≤ 100 Hz Amplitude: ±0.3% rdg. ±0.01% f.s. Phase: ±0.1° For DC Amplitude: ±0.3% rdg. ±0.02% f.s.
Frequency characteristics (Amplitude)	to 500 Hz: ±0.3% rdg. ±0.02% f.s. to 1 kHz: ±0.5% rdg. ±0.02% f.s. to 10 kHz: ±1.5% rdg. ±0.02% f.s. to 100 kHz: ±5.0% rdg. ±0.05% f.s. to 1 MHz: ±30% rdg. ±0.05% f.s.	to 500 Hz: ±0.3% rdg. ±0.02% f.s. to 1 kHz: ±0.5% rdg. ±0.02% f.s. to 10 kHz: ±1.5% rdg. ±0.02% f.s. to 50 kHz: ±5.0% rdg. ±0.02% f.s. to 500 kHz: ±30% rdg. ±0.05% f.s.	to 500 Hz: ±0.3% rdg. ±0.02% f.s. to 1 kHz: ±0.5% rdg. ±0.02% f.s. to 10 kHz: ±1.5% rdg. ±0.02% f.s. to 50 kHz: ±5.0% rdg. ±0.02% f.s. to 200 kHz: ±30% rdg. ±0.05% f.s.
Operating temperature range	-40°C to 85°C (-40°F to 185°F)	-40°C to 85°C (-40°F to 185°F)	-40°C to 85°C (-40°F to 185°F)
Effect of conductor position	±0.1% rdg. or less (DC to 100 Hz)	±0.1% rdg. or less (DC to 100 Hz)	±0.1% rdg. or less (DC to 100 Hz)
Effects of external magnetic fields	In 400 A/m magnetic field (DC and 60 Hz) under 50 mA	In 400 A/m magnetic field (DC and 60 Hz) under 50 mA	In 400 A/m magnetic field (DC and 60 Hz) under 100 mA
Output connector	HIOKI ME15W	HIOKI ME15W	HIOKI ME15W
Dimensions	153 mm (6.02 in) W x 67 mm (2.64 in) H x 25 mm (0.98 in) D Cable length: 3 m (9.84 ft)	153 mm (6.02 in) W x 67 mm (2.64 in) H x 25 mm (0.98 in) D Cable length: 3 m (9.84 ft)	153 mm (6.02 in) W x 67 mm (2.64 in) H x 25 mm (0.98 in) D Cable length: 3 m (9.84 ft)
Mass	350 g (12.3 oz)	370 g (13.1 oz)	400 g (14.1 oz)
Derating Characteristics			

Custom cable lengths also available. Please inquire with your Hioki distributor.

High Accuracy Sensor, Clamp Type

	AC/DC CURRENT PROBE CT6845-05	AC/DC CURRENT PROBE CT6846-05	CLAMP ON SENSOR 9272-05
External Appearance			
Rated primary current	500 A AC/DC	1000 A AC/DC	200 A/20 A AC switching
Frequency band	DC to 100 kHz	DC to 20 kHz	1 kHz to 100 kHz
Diameter of measurable conductors	φ 50 mm (1.97 in) or less (insulated conductor)	φ 50 mm (1.97 in) or less (insulated conductor)	φ 46 mm (1.81 in) or less
Basic accuracy	For DC <math>I <= 100 </math> Hz Amplitude: $\pm 0.3\%$ rdg. $\pm 0.01\%$ f.s. Phase: $\pm 0.1^\circ$ For DC Amplitude: $\pm 0.3\%$ rdg. $\pm 0.02\%$ f.s.	For DC <math>I <= 100 </math> Hz Amplitude: $\pm 0.3\%$ rdg. $\pm 0.01\%$ f.s. Phase: $\pm 0.1^\circ$ For DC Amplitude: $\pm 0.3\%$ rdg. $\pm 0.02\%$ f.s.	For 45 Hz to 66 Hz Amplitude: $\pm 0.3\%$ rdg. $\pm 0.01\%$ f.s. Phase: $\pm 0.2^\circ$
Frequency characteristics (Amplitude)	to 500 Hz: $\pm 0.3\%$ rdg. $\pm 0.02\%$ f.s. to 1 kHz: $\pm 0.5\%$ rdg. $\pm 0.02\%$ f.s. to 10 kHz: $\pm 1.5\%$ rdg. $\pm 0.02\%$ f.s. to 20 kHz: $\pm 5.0\%$ rdg. $\pm 0.02\%$ f.s. to 100 kHz: $\pm 30\%$ rdg. $\pm 0.05\%$ f.s.	to 500 Hz: $\pm 0.5\%$ rdg. $\pm 0.02\%$ f.s. to 1 kHz: $\pm 1.0\%$ rdg. $\pm 0.02\%$ f.s. to 5 kHz: $\pm 2.0\%$ rdg. $\pm 0.02\%$ f.s. to 10 kHz: $\pm 5.0\%$ rdg. $\pm 0.05\%$ f.s. to 20 kHz: $\pm 30\%$ rdg. $\pm 0.10\%$ f.s.	to 10 Hz: $\pm 2.0\%$ rdg. $\pm 0.10\%$ f.s. to 45 Hz: $\pm 0.5\%$ rdg. $\pm 0.02\%$ f.s. to 5 kHz: $\pm 2.5\%$ rdg. $\pm 0.02\%$ f.s. to 10 kHz: $\pm 5.0\%$ rdg. $\pm 0.1\%$ f.s. to 100 kHz: $\pm 30\%$ rdg. $\pm 0.1\%$ f.s.
Operating temperature range	-40°C to 85°C (-40°F to 185°F)	-40°C to 85°C (-40°F to 185°F)	0°C to 50°C (32°F to 122°F)
Effect of conductor position	$\pm 0.2\%$ rdg. or less (DC to 100 Hz)	$\pm 0.2\%$ rdg. or less (50 Hz/60 Hz)	$\pm 0.2\%$ rdg. or less (60 Hz)
Effects of external magnetic fields	In 400 A/m magnetic field (DC and 60 Hz) under 150 mA	In 400 A/m magnetic field (DC and 60 Hz) under 150 mA	In 400 A/m magnetic field (60 Hz) under 100 mA
Output connector	HIOKI ME15W	HIOKI ME15W	HIOKI ME15W
Dimensions	238 mm (9.37 in) W x 116 mm (4.57 in) H x 35 mm (1.38 in) D Cable length: 3 m (9.84 ft)	238 mm (9.37 in) W x 116 mm (4.57 in) H x 35 mm (1.38 in) D Cable length: 3 m (9.84 ft)	78 mm (3.07 in) W x 188 mm (7.40 in) H x 35 mm (1.38 in) D Cable length: 3 m (9.84 ft)
Mass	860 g (30.3 oz)	990 g (34.9 oz)	450 g (15.9 oz)
Derating Characteristics			

Custom cable lengths also available. Please inquire with your Hioki distributor.

Current Summing

	SENSOR UNIT CT9557
External Appearance	FRONT Sensor input REAR Summed waveform output (CT9904 connected)
Connectable current sensor	Current sensor with HIOKI ME15W (male) on the output connector
Summed waveform output accuracy	DC: $\pm 0.06\%$ rdg. $\pm 0.03\%$ f.s. to 1 kHz: $\pm 0.06\%$ rdg. $\pm 0.03\%$ f.s. to 10 kHz: $\pm 0.10\%$ rdg. $\pm 0.03\%$ f.s. to 100 kHz: $\pm 0.20\%$ rdg. $\pm 0.10\%$ f.s. to 300 kHz: $\pm 1.0\%$ rdg. $\pm 0.20\%$ f.s. to 700 kHz: $\pm 5.0\%$ rdg. $\pm 0.20\%$ f.s. to 1 MHz: $\pm 10.0\%$ rdg. $\pm 0.50\%$ f.s.
Operating temperature range	-10°C to 50°C (14°F to 122°F)
Power supply	AC ADAPTER Z1002 (100 to 240 V AC, 50/60 Hz, Max. rated power when in combination with other units: 155 VA) External power supply (10 to 30 V DC, Max. rated power: 60 VA)
Output connector	HIOKI ME15W (male)*
External dimensions	116 mm (4.57 in) W x 67 mm (2.64 in) H x 132 mm (5.20 in) D
Mass	420 g (14.8 oz)
Accessories	AC ADAPTER Z1002, Power cord, Instruction Manual

* CT9904 (sold separately) is required to connect to PW3390.

High Accuracy Sensor, Direct Wire Type

Newly developed DCCT method allows world-class measurement range and measurement accuracy at a rating of 50 A.
(5 A rating version also available. Please inquire with your Hioki distributor.)

	AC/DC CURRENT BOX PW9100-03	AC/DC CURRENT BOX PW9100-04
External Appearance		
Number of input channels	3ch	4ch
Rated primary current	50 A AC/DC	
Frequency band	DC to 3.5 MHz (-3 dB)	
Measurement terminals	Terminal block (with safety cover), M6 screws	
Basic accuracy	For 45 Hz to 65 Hz Amplitude: $\pm 0.02\%$ rdg. $\pm 0.005\%$ f.s. Phase: $\pm 0.1^\circ$ For DC Amplitude: $\pm 0.02\%$ rdg. $\pm 0.007\%$ f.s.	
Frequency characteristics (Amplitude)	to 45 Hz: $\pm 0.1\%$ rdg. $\pm 0.02\%$ f.s. to 1 kHz: $\pm 0.1\%$ rdg. $\pm 0.01\%$ f.s. to 50 kHz: $\pm 1\%$ rdg. $\pm 0.02\%$ f.s. to 100 kHz: $\pm 2\%$ rdg. $\pm 0.05\%$ f.s. to 1 MHz: $\pm 10\%$ rdg. $\pm 0.05\%$ f.s. 3.5 MHz: -3 dB Typical	
Input resistance	1.5 mΩ or less (50 Hz/60 Hz)	
Operating temperature range	0°C to 40°C (32°F to 104°F)	
Effects of common-mode voltage (CMRR)	50 Hz/60 Hz 120 dB or greater 100 kHz 120 dB or greater (Effect on output voltage/common-mode voltage)	
Maximum rated voltage to ground	1000 V (Measurement category II), 600 V (Measurement category III), Anticipated transient overvoltage 6000 V	
Output connector	HIOKI ME15W	
Dimensions	430 mm (16.93 in) W x 88 mm (3.46 in) H x 260 mm (10.24 in) D, Cable length: 0.8 m (2.62 ft)	
Mass	3.7 kg (130.5 oz)	4.3 kg (151.7 oz)
Derating Characteristics		

Standard Sensor

* CT9920 (sold separately) is required to connect PW3390 to the sensor with HIOKI PL14 on the output connector.

	AC/DC CURRENT SENSOR CT7642 AC/DC AUTO ZERO CURRENT SENSOR CT7742	AC FLEXIBLE CURRENT SENSOR CT7044, CT7045, CT7046
External Appearance		
Rated primary current	2000 A AC/DC	6000 A AC
Frequency band	CT7642: DC to 10 kHz CT7742: DC to 5 kHz	10 Hz to 50 kHz (± 3 dB)
Diameter of measurable conductors	φ 55 mm (2.17 in) or less	CT7044: φ 100 mm (3.94 in) or less CT7045: φ 180 mm (7.09 in) or less CT7046: φ 254 mm (10.00 in) or less
Basic accuracy	For DC, 45 Hz to 66 Hz Amplitude: $\pm 1.5\%$ rdg. $\pm 0.5\%$ f.s. For up to 66 Hz Phase: $\pm 2.3^\circ$	For 45 to 66 Hz, with flexible cable core Amplitude: $\pm 1.5\%$ rdg. $\pm 0.25\%$ f.s. Phase: $\pm 1.0^\circ$
Frequency characteristics (Amplitude)	66 kHz to 1 kHz $\pm 2.5\%$ rdg. $\pm 1.0\%$ f.s.	-
Operating temperature range	-25°C to 65°C (-13°F to 149°F)	-25°C to 65°C (-13°F to 149°F)
Effect of conductor position	$\pm 1.0\%$ rdg. or less	$\pm 3.0\%$ or less
Effects of external magnetic fields	In 400 A/m magnetic field (DC) 0.2% f.s. or less	In 400 A/m magnetic field (50 Hz/60 Hz) CT7044, CT7045: 1.25% f.s. or less CT7046: 1.5% f.s. or less
Output connector	HIOKI PL14*	HIOKI PL14*
Dimensions	64 mm (2.52 in) W x 195 mm (7.68 in) H x 34 mm (1.34 in) D Cable length: 2.5 m (8.20 ft)	Circuit box: 25 mm (0.98 in) W x 72 mm (2.83 in) H x 20 mm (0.79 in) D Cable length: 2.5 m (8.20 ft)
Mass	510 g (18.0 oz)	CT7044: 160 g (5.6 oz) CT7045: 174 g (6.1 oz) CT7046: 186 g (6.6 oz)
Derating Characteristics		

Model : POWER ANALYZER PW3390

Model No. (Order Code)	D/A output	Motor analysis
PW3390-01	—	—
PW3390-02	○	—
PW3390-03	○	○

Accessories: Instruction Manual x1, Measurement Guide x1, Power cord x1, USB cable x1, Input cord label x2, D-sub 25-pin connector x1 (PW3390-02, PW3390-03)



- The optional voltage cord and current sensor are required for taking measurements.
- Motor analysis and D/A output cannot be changed or added after delivery.

Current Measurement Options

Name (Note)	Model No. (Order Code)	Name (Note)	Model No. (Order Code)
AC/DC CURRENT SENSOR (50 A)	CT6862-05	CLAMP ON SENSOR (AC 20 A/200 A)	9272-05
AC/DC CURRENT SENSOR (200 A)	CT6863-05	AC/DC CURRENT BOX (50 A, 3 ch)	PW9100-03
AC/DC CURRENT SENSOR (500 A) Ultra-high accuracy	CT6904	AC/DC CURRENT BOX (50 A, 4 ch)	PW9100-04
AC/DC CURRENT SENSOR (500 A)	CT6875	AC/DC AUTO ZERO CURRENT SENSOR (2000 A)	CT7742 *
AC/DC CURRENT SENSOR (500 A)	CT6875-01	AC/DC CURRENT SENSOR (2000 A)	CT7642 *
AC/DC CURRENT SENSOR (1000 A)	CT6876	AC FLEXIBLE CURRENT SENSOR (6000 A, φ 100 mm (3.94 in))	CT7044 *
AC/DC CURRENT SENSOR (1000 A)	CT6876-01	AC FLEXIBLE CURRENT SENSOR (6000 A, φ 180 mm (7.09 in))	CT7045 *
AC/DC CURRENT SENSOR (2000 A)	CT6877	AC FLEXIBLE CURRENT SENSOR (6000 A, φ 254 mm (10.00 in))	CT7046 *
AC/DC CURRENT SENSOR (2000 A)	CT6877-01	SENSOR UNIT (Sensor power supply with 4 channel summing function)	CT9557 **
AC/DC CURRENT PROBE (20 A)	CT6841-05	* CONVERSION CABLE CT9920 is required to connect to PW3390. ** CONNECTION CABLE CT9904 is required to connect to PW3390.	
AC/DC CURRENT PROBE (200 A)	CT6843-05		
AC/DC CURRENT PROBE (500 A, φ 20 mm (0.79 in))	CT6844-05		
AC/DC CURRENT PROBE (500 A, φ 50 mm (1.97 in))	CT6845-05		
AC/DC CURRENT PROBE (1000 A)	CT6846-05	Built-To-Order (Current Measurement)	

* CONVERSION CABLE CT9920 is required to connect to PW3390.
 ** CONNECTION CABLE CT9904 is required to connect to PW3390.

Built-To-Order (Current Measurement)

PW9100 5A-rated model

CT6862-05 high-accuracy model
 CT6863-05 high-accuracy model

Please contact your Hioki distributor or subsidiary for more information.

CONVERSION CABLE CT9900



Required to connect PW3390 to the current sensor with HIOKI PL23 on the output connector.

[Applicable products]
 CT6841, CT6843, CT6844, CT6845, CT6846, CT6862, CT6863, 9272-10

CONVERSION CABLE CT9920



Required to connect PW3390 to the current sensor with HIOKI PL14 on the output connector.

[Applicable products]
 CT7742, CT7642, CT7044, CT7045, CT7046

CONNECTION CABLE CT9904



Cable length: 1 m (3.28 ft) Required to connect the summing waveform output terminal of CT9557 to PW3390.

[Applicable products]
 CT9557

Voltage Measurement Options

VOLTAGE CORD L9438-50



Red, black: 1 each,
 1000 V specification, Cord length:
 3 m (9.84 ft)
 CAT IV 600 V, CAT III 1000 V

EXTENSION CABLE SET L4931



Red, black: 1 each,
 With connector, Cable length: 1.5 m (4.92 ft)
 For extension of L9438-50 or L1000
 CAT IV 600 V, CAT III 1000 V

PATCH CORD L1021-01



Banana branch-banana, Red: 1
 Cable length: 0.5 m
 For branching from the L9438-50 or L1000
 CAT IV 600 V, CAT III 1000 V

VOLTAGE CORD L1000



Red, yellow, blue, gray: 1 each; Black: 4
 1000 V specification, Cord length: 3 m
 (9.84 ft)
 CAT IV 600 V, CAT III 1000 V

GRABBER CLIP 9243



Red, black: 1 each
 Change the tip of the voltage cord to use
 CAT III 1000 V

PATCH CORD L1021-02



Banana branch-banana, Black: 1
 Cable length: 0.5 m
 For branching from the L9438-50 or L1000
 CAT IV 600 V, CAT III 1000 V

WIRING ADAPTER PW9000



When making a 3-phase 3-wire (3P3W3M) connection, this product allows you to reduce the number of voltage cords from 6 to 3.

WIRING ADAPTER PW9001



When making a 3-phase 4-wire (3P4W) connection, this product allows you to reduce the number of voltage cords from 6 to 4.

Other Options



PC CARD 512 MB 9728
 PC CARD 1 GB 9729
 PC CARD 2 GB 9830

Use only PC Cards sold by HIOKI. Compatibility and performance are not guaranteed for PC cards made by other manufacturers. You may be unable to read from or save data to such cards.

Connection Options

CONNECTION CORD L9217



BNC-BNC,
 For motor analysis input
 Cable length: 1.6 m (5.25 ft)

LAN CABLE 9642

Supplied with straight to cross conversion connector,
 Cable length: 5 m (16.41 ft)

Built-To-Order (Other)

D/A output cable



D-sub 25-pin - BNC (male)
 16 ch conversion, Cord length:
 2.5 m (8.20 ft)

Rackmount fittings



For EIA or JIS

Please contact your Hioki distributor or subsidiary for more information.

CONNECTION CABLE 9683



For synchronous measurement,
 Cable length: 1.5 m (4.92 ft)

RS-232C CABLE 9637

9pin-9pin cross
 Cable length: 1.8 m (5.91 ft)

CARRYING CASE 9794



Carrying Case for
 PW3390 and 3390
 448 mm (17.64 in) W
 x 618 mm (24.33 in) H
 x 295 mm (11.61 in) D

*The Bluetooth® word mark and logos are registered trademarks owned by Bluetooth SIG, Inc. and any use of such marks by HIOKI E.E. CORPORATION is under license.
 Note: Company names and Product names appearing in this catalog are trademarks or registered trademarks of various companies.

HIOKI

HIOKI E. E. CORPORATION

HEADQUARTERS

81 Koizumi,
 Ueda, Nagano 386-1192 Japan
<https://www.hioki.com/>



Scan for all regional contact information

DISTRIBUTED BY