

# DIGITALPACKTEST·MULTISP

## Instruction manual [3rd Edition]

## Table of Contents

1. Introduction	4	
2. Precautions for Use of Reagent	4	
3. Precautions for Handling of Cell	4	
4. Precautions for Measurement	5	
5. Basic Measurement Operation Procedures	6	
6. List of Analytes and List of Reagents	8	
7. Normal measurement method	10	
8. Measurement Methods	14	
Al	Aluminum	14
As	Arsenic	15
As-D	Arsenic (Low Range)	17
B-C	Boron (High Range)	18
B	Boron	19
Cl-500	Chloride (High Range)	20
Cl	Chloride	21
ClO-C	Residual Chlorine (High Range)	22
ClO-DPD	Residual Chlorine (Free)	23
T-ClO	Total Residual Chlorine	24
ClO <sub>2</sub>	Chlorine Dioxide	25
NaClO <sub>2</sub>	Sodium Chlorite	26
NaClO <sub>2</sub> -D	Sodium Chlorite (Low Range)	27
CN-2	Free Cyanide	29
CN <sup>T</sup>	Total Cyanide	30
CN <sup>T</sup> -D	Total Cyanide (Low Range)	31
COD	COD with KMnO <sub>4</sub>	32
Color	Color	33
Cr <sup>6+</sup>	Chromium (Hexavalent)	34
Cr <sup>6+</sup> -D	Chromium (Hexavalent) (Low Range)	35
Cr <sup>T</sup>	Total Chromium	36
Cu	Copper	37
Cu-M	Copper (DDTC)	38
DET	Anionic Surfactants	39
F	Fluoride (Free)	40
Fe	Iron	41
Fe-D	Iron (Low Range)	42
Fe <sup>2+</sup>	Iron (Divalent)	43
Fe <sup>2+</sup> -D	Iron (Divalent) (Low Range)	44
Fe <sup>3+</sup>	Iron (Trivalent)	45
FOR	Formaldehyde	46
GLU	Glucose	47
H <sub>2</sub> O <sub>2</sub> -C	Hydrogen Peroxide (High Range)	48
H <sub>2</sub> O <sub>2</sub>	Hydrogen Peroxide	49
HYD	Hydrazine	50
KMnO <sub>4</sub>	Potassium Permanganate Consumption	51
MAL	M-Alkalinity	52
Mn	Manganese	53
Mo	Molybdenum	54
Ni-D	Nickel (DPM)	55
NH <sub>4</sub>	Ammonium	56
NH <sub>4</sub> -N	Ammonium-Nitrogen	57

NH <sub>4</sub> -D	Ammonium (Low Range) .....	58
NH <sub>4</sub> -N-D	Ammonium-Nitrogen (Low Range) .....	59
NO <sub>2</sub> -C	Nitrite (High Range) .....	60
NO <sub>2</sub> -N-C	Nitrite-Nitrogen (High Range) .....	61
NO <sub>2</sub>	Nitrite .....	62
NO <sub>2</sub> -N	Nitrite-Nitrogen .....	63
<b>NO<sub>3</sub>-C</b>	<b>Nitrate (High Range)</b> .....	64
NO <sub>3</sub> -C_1	Nitrate (High Range) (NO <sub>2</sub> <sup>-</sup> ≤ 1mg/L) .....	65
NO <sub>3</sub> -C_2	Nitrate (High Range) (High Range) (NO <sub>2</sub> <sup>-</sup> ≤ 10mg/L) .....	66
<b>NO<sub>3</sub>-N-C</b>	<b>Nitrate-Nitrogen (High Range)</b> .....	67
NO <sub>3</sub> -N-C1	Nitrate-Nitrogen (High Range) (NO <sub>2</sub> <sup>-</sup> -N ≤ 0.3mg/L) .....	68
NO <sub>3</sub> -N-C2	Nitrate-Nitrogen (High Range) (NO <sub>2</sub> <sup>-</sup> -N ≤ 3mg/L) .....	69
<b>NO<sub>3</sub></b>	<b>Nitrate</b> .....	70
NO <sub>3</sub> _1	Nitrate (NO <sub>2</sub> <sup>-</sup> = 0mg/L) .....	71
NO <sub>3</sub> _2	Nitrate (NO <sub>2</sub> <sup>-</sup> ≤ 0.2mg/L) .....	72
NO <sub>3</sub> _3	Nitrate (NO <sub>2</sub> <sup>-</sup> ≤ 5mg/L) .....	73
<b>NO<sub>3</sub>-N</b>	<b>Nitrate-Nitrogen</b> .....	74
NO <sub>3</sub> -N_1	Nitrate-Nitrogen (NO <sub>2</sub> <sup>-</sup> -N = 0mg/L) .....	75
NO <sub>3</sub> -N_2	Nitrate-Nitrogen (NO <sub>2</sub> <sup>-</sup> -N ≤ 0.06mg/L) .....	76
NO <sub>3</sub> -N_3	Nitrate-Nitrogen (NO <sub>2</sub> <sup>-</sup> -N ≤ 1.5mg/L) .....	77
OIL-M	Mineral Oil in Water .....	78
OIL-V	Vegitable Oil in Water .....	79
OIL-S	Oil in Soil .....	80
Pb-SPK	Lead (SPK) .....	81
Phenol	Phenol .....	82
PO <sub>4</sub> -C	Phosphate (High Range) .....	83
PO <sub>4</sub> -P-C	Phosphate-Phosphorus (High Range) .....	84
PO <sub>4</sub>	Phosphate .....	85
PO <sub>4</sub> -P	Phosphate-Phosphorus .....	86
PO <sub>4</sub> -D	Phosphate (Low Range) .....	87
PO <sub>4</sub> -P-D	Phosphate-Phosphorus (Low Range) .....	88
S	Sulfide (Hydrogen sulfide) .....	89
SiO <sub>2</sub>	Silica .....	90
SiO <sub>2</sub> -D	Silica (Low Range) .....	91
SO <sub>4</sub>	Sulfate .....	92
TH	Total Hardness .....	93
TN-2	Total Nitrogen .....	94
TP-2	Total Phosphorus .....	95
Turbid-F	Turbidity (Formazine) .....	96
Turbid-P	Turbidity (Polystyrene) .....	97
Zn-D	Zinc (Low Range) .....	98

- This entire instruction manual is protected by copyright. No part of this instruction manual may be reproduced in any form without permission.
- The contents of this instruction manual are subject to change without notice.
- The specifications of this product are subject to change without notice.
- Changes and additions to analyte will be reported via our website or other media as needed.  
<http://kyoritsu-lab.co.jp>
- PACKTEST and DIGITALPACKTEST are product name of KYORITSU CHEMICAL-CHECK Lab., Corp.

## 1. Instruction

Thank you for purchasing DIGITALPACKTEST·MULTI SP (model: DPM-MTSP).

This product is incorporated with calibration curve data that have been obtained by using PACKTEST or other reagents and enables simple measurement of the concentration of analyte in a sample.

Read this instruction manual before use to thoroughly understand the functions of this product for proper operation.

## 2. Precautions for Use of Reagent

Use reagents made by KYORITSU CHEMICAL-CHECK Lab., Corp. As the reagent varies depending on the analyte, refer to the instructions. Use a reagent after reading the instructions supplied with it, the GHS symbols, and SDS. For precautions and the relevant first aid method on reagent prepared by the user, refer to the SDS supplied from the manufacturer.

### < Safety measurement >

- Thoroughly clean the hands before and after measurement. Do not inhale or contact the reagent.
- Wear PPE such as protective gloves, protective goggles, and mask as much as possible.
- Do not leak reagent or waste liquid into the surrounding environment.

### < First aid >

If reagent or solution **enters your eye**

- immediately wash your eye with water for 15 minutes or longer.  
Immediately consult an ophthalmologist even if you do not experience any pain or abnormal symptoms.

If reagent or solution **contacts your skin or clothing**

- immediately rinse the skin or clothing with water.

If reagent or solution **enters your mouth**

- immediately rinse your mouth with water.

If you have swallowed reagent or solution or you experience any abnormal symptoms after receiving the above treatment, immediately consult a doctor.

For details, refer to the instructions supplied with the reagent or the SDS.

< **Storage** > Store reagent in a cool, dark, and dry place beyond the reach of children.

< **Disposal** > Appropriately dispose of reagent according to the relevant laws and regulations.

< **Others** > Before using a reagent, check its expiration date. Measurement using a reagent beyond its expiration period is invalid.

## 3. Precautions for Handling of Cell

Use PACKTEST Square Cup as a cell. For some analytes, Round Cell is used as a reaction container.

1. Use "PACKTEST Square Cup" (model: WAK-CC10) as the Cell.
2. Use the same Cell in steps from zero adjustment to measurement.
3. The side faces of the Cell serve as an optical path. Do not hold the faces where light passes with your hand.
4. If the water temperature is significantly lower than the ambient temperature, dew may be condensed on the Cell to cause turbid and abnormal measurement value.
5. When setting the Cell in the cell box, cleanly wipe its surface so as not to leave water droplets or finger prints, and then gently put it the cell box.
6. When setting the Cell in the cell box, remove the cap of the cell to prevent the leak.
7. After measurement, take out the Cell or Round Cell, clean it with pure water, because reagent or other substances remaining in it may cause a measurement error in the next measurement. If pure water is not available, thoroughly rinse it with tap water, and then clean it with the sample before conducting the next measurement.
8. As a flaw or dirt on the Cell causes a measurement error, replace the Cell with a new one as necessary.
9. The material of the Cell and that of Round Cell are as follows. Dispose of them according to the relevant instruction of the local government.

Sort of cell	Material of cell	Material of cap
PACKTEST Square Cup	polystyrene	polyethylene
Round Cell	glass	polypropylene (PP)

10. Values displayed when the Cell is not set in the cell box are invalid.

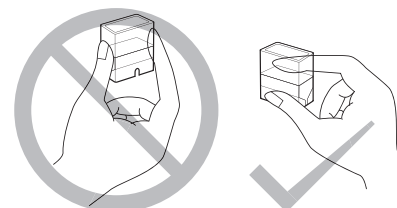

## 4. Precautions for Measurement

1. As a basic measurement method, put the sample in PACKTEST Square Cup, cancel the sample color as of before measurement by pressing **[Zero]** , and then press **[Start]** after sucking the sample into the tube or adding the specified reagent. Have the reagent react with the sample by lightly shaking to produce a solution, and put the Cell to which the solution has been returned in the cell box within the reaction time. Then, the result is automatically displayed when the reaction time ends.
2. As the measurement reagent, the PACKTEST, Reagent Set for Water Analyzer or an analysis set of varying type is used depending on the analyte. When performing measurement by using PACKTEST or an analysis set of varying type, also carefully read the usage document supplied with each set. Note that the reaction time, measurement range, and influence of coexistent substance differ between the case where the Standard Color and the color development are visually compared and the case where measurement is conducted by using this measurement device. Also, depending on the analyte, a special pretreatment method, a tool (sold separately) or a reagent (sold separately or separately procured by the customer) may be required. Carefully read "8. Measurement Methods".
3. Adjust the pH of the sample within the pH range specified for the analyte. As the reagent contains pH buffer, pH adjustment of a sample near neutral is unnecessary, but be sure to neutralize a strong acid or strong alkali sample, in particular an acidified or alkalized sample.
4. If the sample is excessively turbid or colored, zero adjustment may not be possible. Perform filtration, dilution, and the like as necessary.
5. The reagent may not be completely dissolved. This does not affect color development, but floating of the reagent in the solution or attachment of the reagent to the wall surface of the Cell causes a positive measurement error. Therefore, place the Cell during reaction time. If remaining undissolved reagent or bubbles have attached to the wall surface of the Cell, remove them as much as possible by, for example, snapping the Cell with your finger. Be especially careful if such attachment occurs on the low concentration because the error becomes larger.
6. Set the sample temperature to 15 to 30 °C for measurement. Note that for some analytes, temperature correction coefficients are listed. As the calibration curve and various data for DIGITALPACKTEST·MULTI SP have been created at 20°C , measurement at 20°C obtains better measurement data. If the sample temperature greatly deviates from the target temperature, perform measurement in any of the following methods.
  - (1) Perform measurement after setting the sample temperature to 20°C by using a temperature controlled bath or the like.
  - (2) If a temperature correction coefficient is listed in the "CAUTION" column, multiply the measurement value by the coefficient for the temperature nearest to the sample temperature during measurement to obtain an approximate value.
7. A result can be estimated by the shading of the color development of the solution. If a measurement value could be obtained even when no color development occurred, there is a possibility of turbid due to change of pH caused by the color development reagent. Also, note that depending on the analyte, the color development may become pale if its concentration is excessively high or a measurement value may be obtained even from a sample exceeding the measurement range.
8. If a measurement value is out of the measurement range, "UNDER" or "OVER" is displayed.
9. When the concentration of the analyte is considered to be high or when the result is above the measurement range, dilute the sample with pure water so that the result falls within the measurement range.
10. There are data on the influence of coexistent substance for respective items. If coexistent substance is considered to exert influence, perform measurement after an appropriate pretreatment according to JIS K 0102 or other standard. Depending on the type of coexistent substance, measurement may be impossible.
11. The result obtained by Photometry mode using PACKTEST etc. as measuring reagent is not certificated value. For first time use or when doubt about the result, you may need to check the correlation with official method.

## 5. Basic Measurement Operation Procedures

The basic measurement operation procedures are explained below.

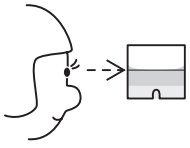

**Fill the Cell with 1.5 mL of sample (up to line).**

Place the Cell on a flat surface.

Move your eyes to the same height as the liquid level, and put the sample up to the point where the lower end of the liquid surface (meniscus) aligns with the line on the Cell.

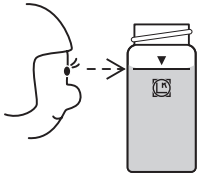

**Fill the Round Cell with 25 mL of sample (up to white line).**

Place the Round Cell on a flat surface.

Move your eyes to the same height as the liquid level, and put the sample up to the point where the lower end of the liquid surface (meniscus) aligns with the line on the Round Cell.

**Zero**

**Press the [ Zero ] button.**

Cancel the color of the sample as of before measurement.

**Start**

**Press the [ Start ] button.**

Count down of the time set on "Reaction time" starts.

As soon as the reaction time ends, the absorbance is measured and the result is displayed.

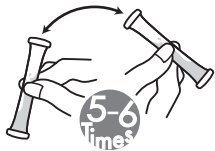

**Lightly shake the tube 5 to 6 times.**

Amount of the sample into the tube of PACKTEST, slowly overturn the tube so as not to spill the sample in it.



**Shake the tube for about 10 times.**

After sucking the whole amount of the sample into the tube of PACKTEST, slowly overturn the tube so as not to spill the sample in it.

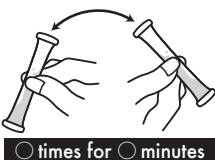

**Stir the sample for XX times in XX minutes.**

After sucking the whole amount of sample into the tube of PACKTEST, overturn the tube at the speed of about one reciprocation per second so as not to spill the sample in it.

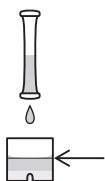

**Return the sample to the Cell when the time count down reaches under XX minutes.**

As bubbles are generated during reaction and they are likely to attach to the wall surface of the Cell, return the solution from the tube of PACKTEST to the Cell XX minutes before the end of reaction time.

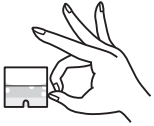

**Snap the Cell with your finger to remove the bubbles on the wall surface.**

If bubbles remain after returning the solution to the Cell, snap the Cell with your finger to remove the bubbles on the wall surface.



**Wait for XX minutes.**

The waiting time is displayed inside the mark.  
Wait after placing the Cell or the Round Cell on a flat surface.  
Or place the tube after shaking.



**Stir 5 to 6 times.**

Hold the top part of the Round Cell and stir the solution in a circular motion.



**Shake 5 to 6 times.**

Vertically shake the Round Cell 5 to 6 times so that the liquid in it is well mixed.



**Immediately shake strongly for approx. 10 seconds.**

Attach the cap immediately after adding the reagent, and shake the Round Cell strongly for approx. 10 seconds at the speed of about 2 reciprocations per second.

## 6. List of Analytes and List of Reagents

As a major reagent, PACKTEST (sample amount: 1.5 mL, model: WAK -), Reagent Set for Water Analyzer (sample amount: 25 mL, model: LR -), analysis set of varying types (model: WA -), and DPR reagent for water analyzer (model: DPR -) are used.

Analyte	Range(mg/L)	Reaction Time	Reagent Model	Note / Necessary instruments
Al Aluminum	0.05 ~ 0.40	5 min.	LR-Al	
As Arsenic	0.20 ~ 3.00	[30 min.]	DPR-As	
As-D Arsenic(Low Range)	0.009 ~ 0.200	[12 min.]	SPK-As(D)	
B-C Boron(High Range)	5.0 ~ 80.0	12 min.	WAK-B(C)	
B Boron	0.50 ~ 6.00	40 min.	WAK-B	
Cl-500 Chloride(High Range)	20 ~ 500	3 min.	DPR-Cl	
Cl Chloride	2.0 ~ 50.0	3 min.	DPR-Cl	
ClO-C Residual Chlorine(High Range)	2 ~ 500	1 min.	WAK-ClO(C)	
ClO-DPD Residual Chlorine(Free)	0.05 ~ 3.00	1 min.	WAK-ClO·DP	
T-ClO Total Residual Chlorine	0.05 ~ 3.00	2 min.	WAK-T·ClO	
ClO <sub>2</sub> Chlorine Dioxide	0.20 ~ 6.00	30 sec.	WAK-ClO <sub>2</sub>	
NaClO <sub>2</sub> Sodium Chlorite	2 ~ 500	1 min.	WAK-NaClO <sub>2</sub>	
NaClO <sub>2</sub> -D Sodium Chlorite(Low Range)	0.10 ~ 2.00	1 min.	WAK-NaClO <sub>2</sub> (D)	
CN-2 Free Cyanide	0.01 ~ 1.00	10 min.	WAK-CN-2	
CN <sup>T</sup> Total Cyanide	0.1 ~ 3.0	[18 min.]	LR-CN <sup>T</sup>	Water Analysis Set: Total Cyanide
CN <sup>T</sup> -D Total Cyanide(Low Range)	0.005 ~ 0.150	[40 min.]	LR-CN-B	Water Analysis Set: Total Cyanide (Low Range)
COD COD with KMnO <sub>4</sub>	2.0 ~ 10.0	10 min.	LR-COD-B	
Color Color	50 ~ 1000deg.	0 min.	-	
Cr <sup>6+</sup> Chromium(Hexavalent)	0.05 ~ 1.50	2 min.	WAK-Cr <sup>6+</sup>	
Cr <sup>6+</sup> -D Chromium(Hexavalent) (Low Range)	0.003 ~ 0.100	[10 min.]	DPR-Cr <sup>6+</sup> D	
Cr <sup>T</sup> Total Chromium	0.05 ~ 1.50	[12 min.]	WAK-Cr <sup>6+</sup>	Cr-RA
Cu Copper	0.10 ~ 5.00	1 min.	WAK-Cu	
Cu-M Copper(DDTC)	0.5 ~ 5.0	3 min.	WAK-CuM	
DET Anionic Surfactants	0.05 ~ 1.20	[3 min.]	WA-DET	
F Fluoride(Free)	0.40 ~ 1.50	15 min.	WAK-F	
Fe Iron	0.10 ~ 5.00	3 min.	WAK-Fe	
Fe-D Iron(Low Range)	0.05 ~ 2.00	3 min.	WAK-Fe(D)	
Fe <sup>2+</sup> Iron(Divalent)	0.10 ~ 5.00	3 min.	WAK-Fe <sup>2+</sup>	
Fe <sup>2+</sup> -D Iron(Divalent) (Low Range)	0.05 ~ 2.00	3 min.	WAK-Fe <sup>2+</sup> (D)	
Fe <sup>3+</sup> Iron(Trivalent)	1.0 ~ 50.0	1 min.	WAK-Fe <sup>3+</sup>	
FOR Formaldehyde	0.20 ~ 1.00	5 min.	WAK-FOR	
GLU Glucose	0.5 ~ 20.0	12 min.	WAK-GLU	
H <sub>2</sub> O <sub>2</sub> -C Hydrogen Peroxide(High Range)	1 ~ 200	1 min.	WAK-H <sub>2</sub> O <sub>2</sub> (C)	
H <sub>2</sub> O <sub>2</sub> Hydrogen Peroxide	0.10 ~ 2.50	2 min.	WAK-H <sub>2</sub> O <sub>2</sub>	
HYD Hydrazine	0.03 ~ 1.00	20 min.	WAK-HYD	
KMnO <sub>4</sub> Potassium Permanganate Consumption	2.0 ~ 10.0	10 min.	LR-COD-B	Use the same Reagent as COD
MAL M-Alkalinity	20 ~ 80	2 min.	WAK-MAL	
Mn Manganese	0.5 ~ 20.0	3 min.	WAK-Mn	
Mo Molybdenum	5 ~ 150	2 min.	WAK-Mo	



Analyte		Range(mg/L)	Reaction Time	Reagent Model	Note / Necessary instruments
Ni-D	Nickel(DPM)	0.3 ~ 10.0	2 min.	WAK-Ni(D)	
NH <sub>4</sub>	Ammonium	0.20 ~ 5.00	10 min.	WAK-NH <sub>4</sub>	
NH <sub>4</sub> -N	Ammonium-Nitrogen	0.20 ~ 4.00	10 min.	WAK-NH <sub>4</sub>	
NH <sub>4</sub> -D	Ammonium(Low Range)	0.05 ~ 2.00	[30 min.]	LR-NH <sub>4</sub> -A	Water Analysis Set: Ammonium (Low Range)
NH <sub>4</sub> -N-D	Ammonium-Nitrogen(Low Range)	0.05 ~ 1.50	[30 min.]	LR-NH <sub>4</sub> -A	Water Analysis Set: Ammonium (Low Range)
NO <sub>2</sub> -C	Nitrite(High Range)	3 ~ 100	5 min.	WAK-NO <sub>2</sub> (C)	
NO <sub>2</sub> -N-C	Nitrite-Nitrogen(High Range)	1.0 ~ 30.0	5 min.	WAK-NO <sub>2</sub> (C)	
NO <sub>2</sub>	Nitrite	0.02 ~ 1.00	3 min.	WAK-NO <sub>2</sub>	
NO <sub>2</sub> -N	Nitrite-Nitrogen	0.010 ~ 0.300	3 min.	WAK-NO <sub>2</sub>	
NO <sub>3</sub> -C_1	Nitrate(High Range)(NO <sub>2</sub> <sup>-</sup> ≤1 mg/L)	200 ~ 2000	5 min.	WAK-NO <sub>3</sub> (C)	
NO <sub>3</sub> -C_2	Nitrate(High Range)(NO <sub>2</sub> <sup>-</sup> ≤10mg/L)	200 ~ 2000	[10 min.]	WAK-NO <sub>3</sub> (C)	NO <sub>3</sub> -RA, Heater
NO <sub>3</sub> -N-C1	Nitrate-Nitrogen(High Range)(NO <sub>2</sub> <sup>-</sup> -N≤0.3mg/L)	45 ~ 450	5 min.	WAK-NO <sub>3</sub> (C)	
NO <sub>3</sub> -N-C2	Nitrate-Nitrogen(High Range)(NO <sub>2</sub> <sup>-</sup> -N≤3mg/L)	45 ~ 450	[10 min.]	WAK-NO <sub>3</sub> (C)	NO <sub>3</sub> -RA, Heater
NO <sub>3</sub> _1	Nitrate(NO <sub>2</sub> <sup>-</sup> =0 mg/L)	1.0 ~ 25.0	5 min.	WAK-NO <sub>3</sub>	
NO <sub>3</sub> _2	Nitrate(NO <sub>2</sub> <sup>-</sup> ≤0.2 mg/L)	1.0 ~ 25.0	[8 min.]	WAK-NO <sub>3</sub>	WAK-NO <sub>2</sub>
NO <sub>3</sub> _3	Nitrate(NO <sub>2</sub> <sup>-</sup> ≤5mg/L)	1.0 ~ 25.0	[10 min.]	WAK-NO <sub>3</sub>	NO <sub>3</sub> -RA, Heater
NO <sub>3</sub> -N_1	Nitrate-Nitrogen(NO <sub>2</sub> <sup>-</sup> -N=0mg/L)	0.20 ~ 5.80	5 min.	WAK-NO <sub>3</sub>	
NO <sub>3</sub> -N_2	Nitrate-Nitrogen(NO <sub>2</sub> <sup>-</sup> -N≤0.06mg/L)	0.20 ~ 5.80	[8 min.]	WAK-NO <sub>3</sub>	WAK-NO <sub>2</sub>
NO <sub>3</sub> -N_3	Nitrate-Nitrogen(NO <sub>2</sub> <sup>-</sup> -N≤1.5mg/L)	0.20 ~ 5.80	[10 min.]	WAK-NO <sub>3</sub>	NO <sub>3</sub> -RA, Heater
OIL-M	Mineral Oil in Water	5.0 ~ 60.0	[15 min.]	WA-OIL-R	Water Analysis Reagent Set: Oil (resolution : 0.5 mg/L)
OIL-V	Vegetable Oil in Water	5.0 ~ 60.0	[15 min.]	WA-OIL-R	Water Analysis Reagent Set: Oil (resolution : 0.5 mg/L)
OIL-S	Oil in Soil	400 ~ 5000mg/kg	[10 min.]	SOA-OIL-RR	Soil Screening Reagent Set: Oil (resolution : 100 mg/kg)
Pb-SPK	Lead(SPK)	0.03 ~ 0.50	[12 min.]	SPK-Pb	
Phenol	Phenol	0.20 ~ 5.00	8 min.	WAK-PNL	
PO <sub>4</sub> -C	Phosphate(High Range)	2.0 ~ 50.0	3 min.	WAK-PO <sub>4</sub> (C)	
PO <sub>4</sub> -P-C	Phosphate-Phosphorus(High Range)	0.7 ~ 15.0	3 min.	WAK-PO <sub>4</sub> (C)	
PO <sub>4</sub>	Phosphate	0.10 ~ 5.00	3 min.	WAK-PO <sub>4</sub>	
PO <sub>4</sub> -P	Phosphate-Phosphorus	0.03 ~ 1.50	3 min.	WAK-PO <sub>4</sub>	
PO <sub>4</sub> -D	Phosphate(Low Range)	0.10 ~ 3.00	5 min.	WAK-PO <sub>4</sub> (D)	
PO <sub>4</sub> -P-D	Phosphate-Phosphorus(Low Range)	0.03 ~ 1.00	5 min.	WAK-PO <sub>4</sub> (D)	
S	Sulfide(Hydrogen sulfide)	0.05 ~ 0.80	3 min.	WAK-S	
SiO <sub>2</sub>	Silica	3.0 ~ 60.0	8.5 min.	WAK-SiO <sub>2</sub>	
SiO <sub>2</sub> -D	Silica(Low Range)	0.30 ~ 7.00	8.5 min.	WAK-SiO <sub>2</sub> (D)	
SO <sub>4</sub>	Sulfate	5 ~ 100	3 min.	DPR-SO <sub>4</sub>	
TH	Total Hardness	10 ~ 150	1 min.	WAK-TH	
TN-2	Total Nitrogen	0.5 ~ 7.0	[60 min.]	TNP-N-R	Mini Autoclave Set Heater
TP-2	Total Phosphorus	0.10 ~ 2.00	[60 min.]	TNP-P-R	Mini Autoclave Set Heater
Turbid-F	Turbidity(Formazine)	10 ~ 400deg.	0 min.	—	
Turbid-P	Turbidity(Polystyrene)	10 ~ 100deg.	0 min.	—	
Zn-D	Zinc(Low Range)	0.02 ~ 0.40	6 min.	WAK-Zn(D)	

Reaction Time: [ ] are estimated reaction time including pretreatment procedure. Specifications subject to change without notice.

## 7. Normal measurement method

### Photometry(1 item)

#### Selecting analyte

1. Press **[Photometry]** on [Main window].
2. [Analyte Selection Window] is displayed.
  - Pressing **[▼]** brings you to the next page.
  - Pressing **[▲]** brings you to the previous page.
3. Press the desired analyte symbol.
4. The analyte name and the name of reagent used are displayed, and the analyte symbol is displayed in an input button.
5. Pressing **[OK]** brings you to [Photometry Window].

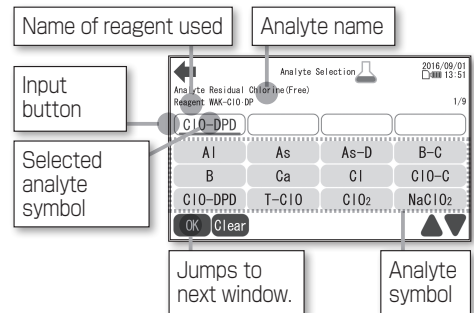

#### Canceling analyte

1. Press an input button on which the desired analyte symbol is displayed.
2. Pressing **[Clear]** clears the contents of the input button and the analyte is canceled.



#### Performing zero adjustment

1. Fill the Cell with the sample.
2. Put the Cell in the cell box.
3. Press **[Zero]**.
4. When the zero adjustment finishes, the color of **[Zero]** is inverted. "0" is displayed in the result display area.



- Zero adjustment can be performed any number of times.
- During measurement, **[Zero]** is disabled.
- After measurement, the color inversion of **[Zero]** returns to the original state.

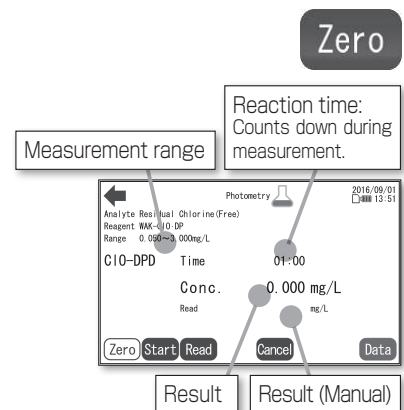

#### Performing measurement

1. After zero adjustment, mix the sample with the reagent. At the same time, press **[Start]**.
2. The color of **[Start]** is inverted and countdown of reaction time starts.
3. Pour the solution to the Cell and put the Cell in the cell box.
4. After the reaction time has elapsed, the result is displayed.
5. The result will be saved automatically. (When a memory card is inserted)
6. The result will be printed out automatically. (When a printer is connected)



- Before zero adjustment, **[Start]** is disabled.
- At 30 seconds before the reaction time ends, the buzzer issues a bleep as a reminder to set the cell.
- After measurement, the color inversion of **[Start]** returns to the original color.
- After measurement, **[Start]** is disabled. Perform the steps from zero adjustment.
- During measurement, it is not possible to turn off the power supply.
- Even when a memory card is inserted, automatic saving may not be executed if it is locked or the data in it have reached the upper limit.

## Performing manual measurement

1. Press **[Read]**.
2. A result is displayed.
3. The result will be saved automatically. (When a memory card is inserted)
4. The result will be printed out automatically. (When a printer is connected)

**Read**



- Manual measurement is enabled after zero adjustment, during measurement and after measurement finished.
- Even when a memory card is inserted, automatic saving may not be executed if it is locked or the data in it have reached the upper limit.

## Canceling measurement

1. Press **[Cancel]**.
2. The instrument state returns to the state as of before zero adjustment.

**Cancel**



- After zero adjustment, **[Cancel]** is enabled.
- During measurement, measurement is canceled. The stopped measurement cannot be resumed.
- If **[Cancel]** is pressed during and after measurement, the result are deleted from the window.
- To turn off the power during measurement, first press **[Cancel]** .

## Viewing data

1. Press **[Data]**.
2. [Photometry Data Window] is displayed.
3. It is possible to view the past results stored in the memory card.

**Data**

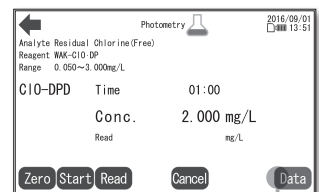

Jumps to next window.

## Photometry (parallel measurement of four samples)

Measurement for multiple analytes or measurement of multiple samples for the same analyte can be performed in parallel.

It is possible to set items 1 to 4.

### Measurement example 1 (multiple analytes)

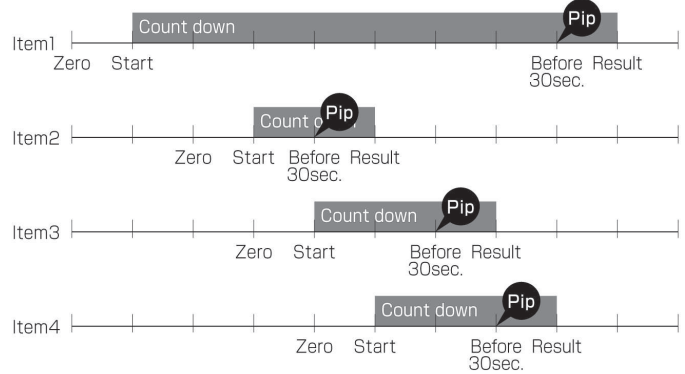

### Measurement example 2 (multiple samples for the same analyte)

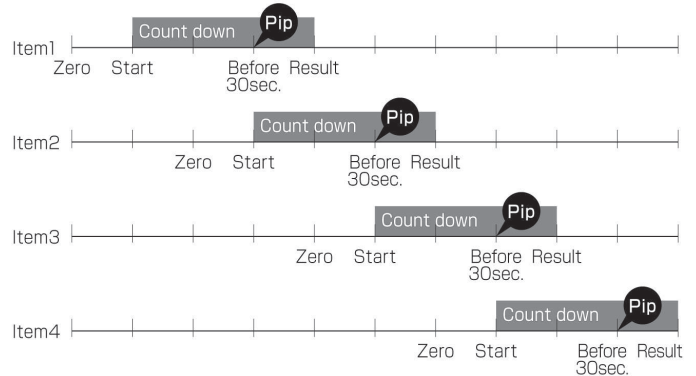

## Selecting analyte

1. Press **[Photometry]** on [Main Window].
2. [Analyte Selection Window] is displayed.
3. Press an input button.
4. Press the desired analyte symbol.
5. The analyte name and the name of reagent used are displayed, and the analyte symbol is displayed in an input button. (Selection of item 1 has finished.)
6. Press a different input button from that in Step 3. The cursor moves.
7. If you press a analyte symbol, a analyte name and the name of reagent used are displayed, and the corresponding analyte symbol is displayed in an input button. (Selection of item 2 has finished.)
8. To set item 3 and item 4, repeat the steps 6 to 7.
9. Pressing **[OK]** brings you to [Photometry Window].

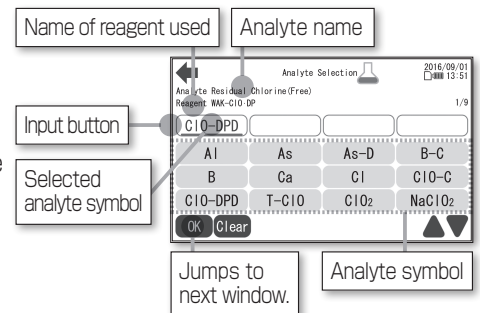

## Canceling analyte

1. Press an input button on which the desired analyte symbol is displayed.
2. Pressing **[Clear]** clears the contents of the input button and the analyte is canceled.

Clear

## [Item 1] Performing zero adjustment and measurement

1. Fill the Cell with the sample.
2. Put the Cell in the cell box.
3. Press **[Zero]**.
4. When the zero adjustment finishes, the color of **[Zero]** is inverted. "0" is displayed in the result display area for item 1.
5. After zero adjustment, mix the sample with the reagent. At the same time, press **[Start]**.
6. The color of **[Start]** is inverted and countdown of reaction time starts.
7. Pour the solution to the Cell.

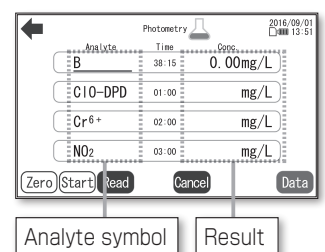

Zero

Start



- Inversion of **[Zero]** and **[Start]** indicates the state of the selected analyte.

## [Item2] Performing zero adjustment and measurement

1. Fill the Cell with the sample.
2. Press the desired analyte symbol for item 2.
3. The inverted state of **[Zero]** and **[Start]** returns to the original state.
4. Put the Cell in the cell box.
5. Press **[Zero]**.
6. Mix the sample with the reagent. At the same time, press **[Start]**.
7. Pour the solution to the Cell.

Zero

Start



- Repeat the same steps for item 3 and item 4.

## Finishing measurement

1. A flag is displayed on the analyte whose reaction time finishes most early.
2. Put the Cell for the analyte indicated with the flag in the cell box.
3. After the reaction time has elapsed, the result is displayed in black in the result display area.
4. The result will be saved automatically.
5. The result will be printed out automatically.
6. A flag is displayed on the analyte whose reaction time finishes next.
7. Repeat steps 2 to 6.

Analyte	Time	Conc.
B	35:42	0.00mg/L
C10-DPD	00:38	0.00mg/L
Cr6+	02:00	mg/L
NO <sub>2</sub>	03:00	mg/L

Buttons: Zero, Start, Read, Cancel, Data

Flag

## Performing manual measurement

1. Press a analyte symbol for which you want to perform manual measurement.
2. Press **[Read]**.
3. A result is displayed in **red**. \* is displayed at the right end.
4. The result will be saved automatically.
5. The result will be printed out automatically.

Read

## Canceling measurement

1. Press a analyte symbol whose measurement you want to cancel.
2. Press **[Cancel]**.
3. Only for the selected analyte, the state returns to that of before zero adjustment.

Cancel



- Only for the selected analyte, **[Cancel]** is enabled.
- After zero adjustment, **[Cancel]** is enabled.
- During measurement, measurement is stopped. The stopped measurement cannot be resumed.
- If **[Cancel]** is pressed during and after measurement, the result are deleted from the window.
- To turn off the power during measurement, first cancel the ongoing measurement.

## Viewing data

1. Press **[Data]**.
2. [Photometry Data Window] is displayed.
3. It is possible to view the past results stored in the memory card.

Data



- During countdown of reaction time, **[Data]** is disabled.

## 8. Measurement Methods

### Al Aluminum

Color development : Yellow → Orange → Red  
Method : ECR  
Range : 0.05 — 0.40 mg/L (ppm)  
Reagent : LR-Al No.24 R-1 (Liquid) , R-2 (Pack)  
Reaction time : 5 min. after R-2 reagent is added.

Cell : PACKTEST Square Cup  
Wavelength : 533 nm, 560 nm

#### Procedure

1. Press **[Al]**.
2. Press **[OK]** to switch to the photometry window.
3. Fill the Cell with the sample for 1.5 mL (up to line) and fill the Round Cell with the sample for 25 mL (up to white line). (Fig.1)
4. Put the Cell in the cell box and press **[Zero]** . Discard the sample in the Cell. (Fig.2)
5. Add 2 mL of R-1 reagent into the Round Cell using the supplied pipette, tightly attach the cap, and shake the Round Cell 5 to 6 times. (Fig.3)
6. Add the R-2 reagent, press **[Start]** , tightly attach the cap, and intensely shake the Round Cell for approx. 10 seconds. (Fig.4)
7. Within 5 minutes, pour the solution in the Round Cell for 1.5 mL into the Cell that has gone through zero adjustment (up to line) and put the Cell in the cell box. (Fig.5)
8. After 5 minutes have elapsed, the concentration will be automatically displayed.

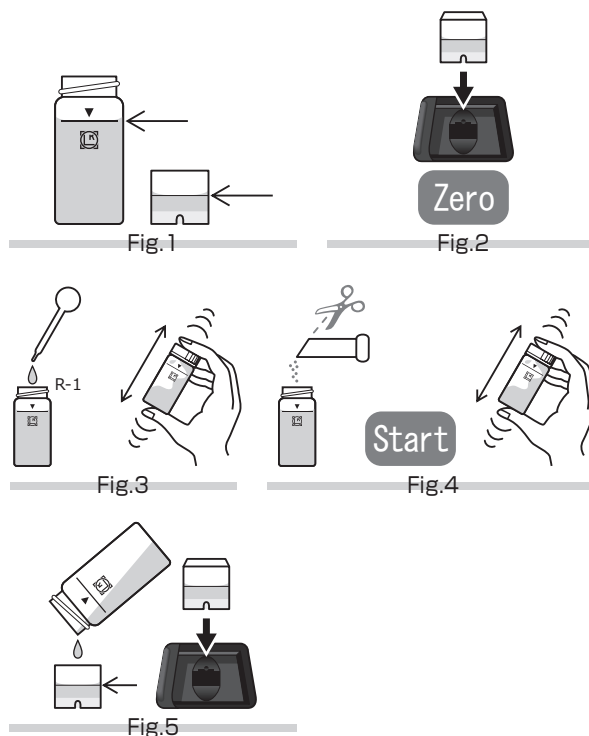

#### Caution

1. In this method, the concentration of ionized aluminum ( $\text{Al}^{3+}$ ) in the sample is measured. If result of Aluminum concentration including suspension and precipitate is required, dissolve Aluminum in advance and then perform measurement.
2. The dissolved state of aluminum greatly varies depending on the pH of the sample, and aluminum could exist in the form of suspended solid or precipitate. Perform measurement after pretreatment according to the measurement purpose.
3. The optimum pH during color development is 6. If this pH cannot be achieved, neutralize the sample as necessary.  
A sample with a small buffering capacity can be measured even if its pH is around 2.
4. Perform measurement with the sample temperature set to 15 to 30°C .
5. Use of a measuring pipette or the like instead of the supplied pipette enables more accurate measurement.

#### Influence of coexisting substance

The stored calibration curve has been created by using the standard solution. If the influence of other substance is considered, check the measurement value by comparing it with the official method or by standard addition method.

The right chart is the list of interference data for acceptable level by adding each of the single substances to the standard solution.

It is not possible to measure seawater.

##### Except for Heavy metal ions:

≤ 100mg/L.: B (III) ,  $\text{Ca}^{2+}$  ,  $\text{Cl}^-$  ,  $\text{I}^-$  ,  $\text{K}^+$  ,  $\text{Mg}^{2+}$  ,  $\text{Na}^+$  ,  $\text{NH}_4^+$  ,  $\text{NO}_2^-$  ,  $\text{NO}_3^-$  ,  $\text{SO}_4^{2-}$  , Anionic Surfactant , Phenol , Residual Chlorine  
≤ 10mg/L.:  $\text{PO}_4^{3-}$   
< 1mg/L.:  $\text{F}^-$

##### Heavy metal ions:

≤ 10mg/L.:  $\text{Ba}^{2+}$  ,  $\text{CN}^-$  ,  $\text{Co}^{2+}$  ,  $\text{Cu}^{2+}$  ,  $\text{Fe}^{2+}$  ,  $\text{Fe}^{3+}$  ,  $\text{Mn}^{2+}$  , Mo (VI) ,  $\text{Ni}^{2+}$  ,  $\text{Zn}^{2+}$   
≤ 1mg/L.:  $\text{Cr}^{3+}$   
< 1mg/L.: Cr (VI)

#### Information on reagent

Refer to the enclosed paper to the reagent.  
The pH of the solution is about 6.

## As Arsenic

Color development: None → Light blue → Blue

Method : Molybdenum Blue

Range : 0.20 — 3.00 mg/L (ppm)

Reagent : DPR-As R-1 (Liquid) , R-2 (Liquid) , R-3 (Liquid) , R-4 (Liquid) , Tube

Reaction time : 5 min. after drawing sample into the tube.

Cell : PACKTEST Square Cup

Wavelength : 650 nm

### Features

In the Molybdenum-blue absorptiometry method, which is the color development principle of this product, the colors of arsenate ions ( $\text{As(V)}$ ) and phosphate ions ( $\text{PO}_4^{3-}$ ) develop in the same manner.

If arsenate ions, arsenite ions ( $\text{As(III)}$ ) and phosphate ions exist in the sample, first reduce the arsenate ions into arsenite ions and develop the color of phosphate ions only, and use this color as a reference. (the upper row of "Measurement chart" below)

Next, oxidize the arsenite ions into arsenate ions and develop their color together with the original arsenate ions and phosphate ions. (The lower row of "Measurement chart" below)

The total value of arsenate ions and arsenite ions is obtained through subtraction between these two color developments, and it is converted into an arsenic value.

### Caution

If phosphate ions coexist at a concentration of 1 mg/L or higher, it is not possible to measure the concentration of arsenate ions.

### Measurement chart

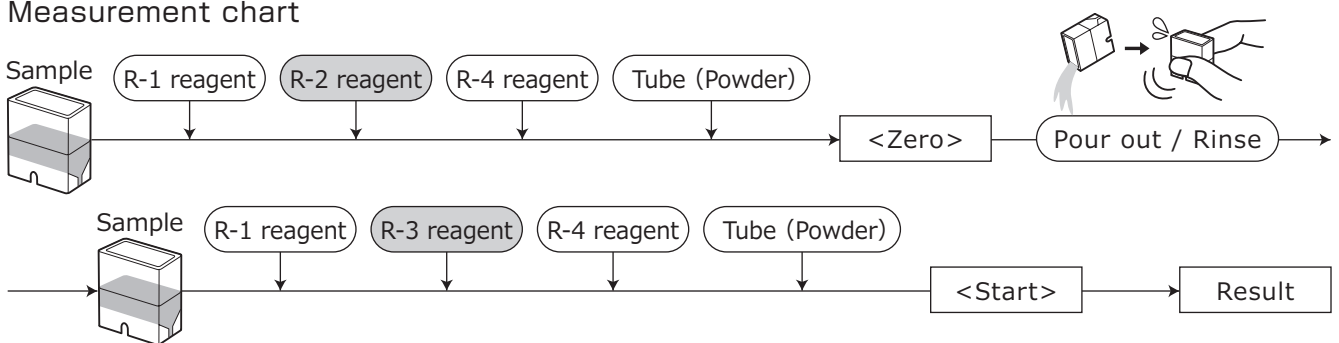

### Procedure

First, develop the color of phosphate ions only for the purpose of zero adjustment.

1. Fill the Cell with the sample for 1.5 mL (up to line). (Fig.1)
2. Add one droplet of R-1 reagent, attach the cap, and shake the Cell 2 to 3 times. (Fig.2)
3. Add two droplets of R-2 reagent, attach the cap, shake the Cell 2 to 3 times, and leave for 10 minutes. (Fig.3)
4. Add four droplets of R-4 reagent, attach the cap, and shake the Cell 2 to 3 times. (Fig.4)
5. Suck the whole amount of the sample in the Cell into the tube and then lightly shake the tube 5 to 6 times. (Fig.5)
6. Return the solution to the Cell and wait for 5 minutes. (Fig.6)

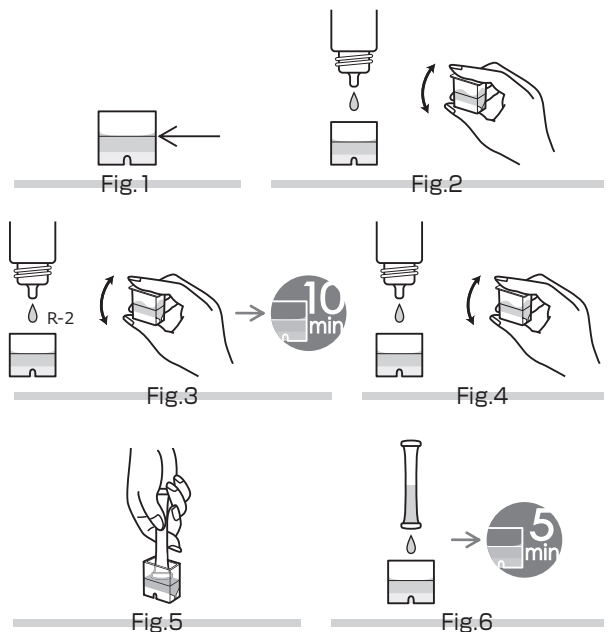

7. Press **[As]**.

8. Press **[OK]** to switch to the photometry window.

9. Put the Cell in which only the color of phosphate has been developed in the cell box, and press **[Zero]**. (Fig.7)

10. Take the Cell out of the cell box, empty it, and clean the Cell and cap with pure water. (Fig.8)

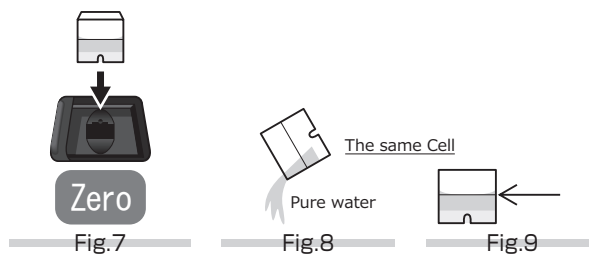

Next, develop the colors of phosphate ions, arsenate ions and arsenite ions, and obtain a result.

11. Fill the Cell in Step 10 with the sample for 1.5 mL (up to line). (Fig.9)

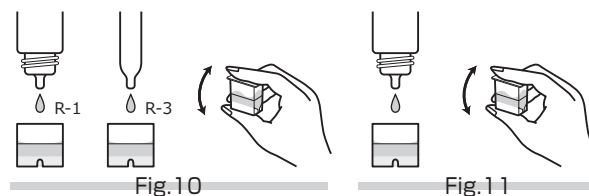

12. Add one droplet of R-1 reagent and one droplet of R-3 reagent, attach the cap, and shake the Cell 2 to 3 times. (Fig.10)

13. Add four droplets of R-4 reagent, attach the cap, and shake the Cell 2 to 3 times. (Fig.11)

14. Suck the whole amount of the sample in the Cell into the tube and press **[Start]** at the same time. (Fig.12)

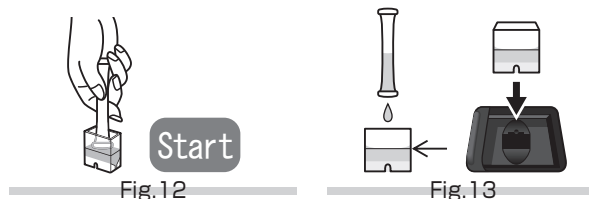

15. Lightly shake the tube in Step 14 from 5 to 6 times, return the solution in the tube to the Cell in a gentle manner, set it again in the cell box. (Fig.13)

16. After 5 minutes have elapsed, the concentration will be automatically displayed.

## Caution

1. In this method, it is possible to measure the concentration of arsenate ions (As ( V )) and arsenite ions (As ( III )) in the sample, and not possible to measure the concentration of arsenic in other forms.
2. The optimum pH during color development is 2. If the pH of the sample is not within the range from 2 to 9, neutralize the sample with dilute sulfuric acid or dilute sodium hydroxide solution, etc.
3. It is not possible to perform measurement of a sample containing arsenate ions at a concentration of 10 mg/L or higher or a sample in a highly oxidized state.

## Influence of coexisting substance

The stored calibration curve has been created by using the standard solution. If the influence of other substance is considered, check the measurement value by comparing it with the official method or by standard addition method.

The right chart is the list of interference data for acceptable level by adding each of the single substances to the standard solution.

Oxidizing substance or reductive substance may affect the measurement.

It is not possible to measure seawater.

≤ 1000mg/L.: B (III), Cl<sup>-</sup>, CN<sup>-</sup>, K<sup>+</sup>, Na<sup>+</sup>, NH<sub>4</sub><sup>+</sup>, SO<sub>4</sub><sup>2-</sup>, Zn<sup>2+</sup>  
≤ 500mg/L.: Ca<sup>2+</sup>, Mg<sup>2+</sup>, NO<sub>3</sub><sup>-</sup>  
≤ 200mg/L.: NO<sub>2</sub><sup>-</sup>  
≤ 100mg/L.: Cr<sup>3+</sup>, Ni<sup>2+</sup>, Silica  
≤ 50mg/L.: Al<sup>3+</sup>, Co<sup>2+</sup>, F<sup>-</sup>, I<sup>-</sup>, Mn<sup>2+</sup>, Mo (VI), Phenol  
≤ 10mg/L.: Fe<sup>2+</sup>, Fe<sup>3+</sup>  
≤ 5mg/L.: Cr (VI)  
≤ 1mg/L.: PO<sub>4</sub><sup>3-</sup>, Residual Chlorine  
< 1mg/L.: Ba<sup>2+</sup>, Cu<sup>2+</sup>

## Information on reagent

Refer to the instruction supplied with "DPR Reagent: Arsenic".

The pH of the solution is 2 or less.



## As-D Arsenic (Low Range)

Color development: None → Light blue → Blue

Method : Membrane Separation with APDC / Molybdenum Blue

Range : 0.009 — 0.200 mg/L(ppm)

Reagent : PACKTEST Arsenic (Low Range) (Model: SPK-As(D)) K-1 (Liquid) , K-2 (Liquid) , K-3 (Liquid) , K-4 (Liquid) , Tube

Reaction time : 5 min. after drawing sample into the tube.

Usage : Read the instruction supplied with "PACKTEST Arsenic (Low Range)".

Cell : PACKTEST Square Cup

Wavelength : 640 nm

### Procedure

1. Press [As-D].
2. Press [OK] to switch to the photometry window.
3. Perform procedures of "Collection" in the instruction supplied with "PACKTEST Arsenic (Low Range)".
4. Press the treated filter onto the syringe firmly, and connect the nozzle. (Fig.1)
5. Fill the Cell with K-3 Reagent for 1.5 mL (up to line). (Fig.2)
6. Put the Cell in the cell box and press [Zero]. (Fig.3)
7. Add four droplets of K-4 Reagent to the Cell. (Fig.4)
8. Draw the solution slowly from the Cell into the syringe, as much as possible. Press out the solution **slowly** to the Cell. **Repeat** this step twice. (Fig.5)
9. Press out the solution completely to the Cell. (Fig.6)
10. Suck the whole amount of the solution in the Cell into the tube and press [Start] at the same time. (Fig.7)
11. Invert the tube lightly end to end for 30 times to mix with reagent. (Fig.8)
12. Return the solution back into the Cell slowly, and set the Cell into the cell box. (Fig.9)
13. After 5 minutes have elapsed, the concentration will be automatically displayed.

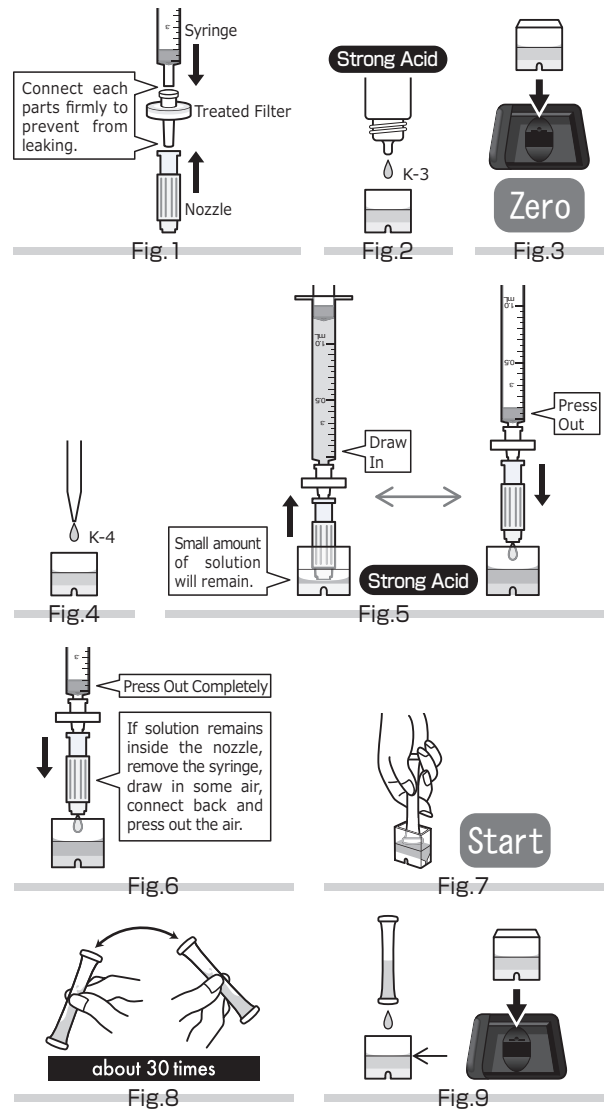

### Caution

1. Refer to the instruction supplied with "PACKTEST Arsenic (Low Range)".
2. Perform measurement with the solution temperature set to 15 to 30°C .

### Influence of coexisting substance

Refer to the instruction supplied with "PACKTEST Arsenic (Low Range)".

### Information on reagent

Refer to the instruction supplied with "PACKTEST Arsenic (Low Range)".  
The pH of the solution is 2 or less.

## B-C Boron (High Range)

Color development: Light yellow → Yellow  
Method : Azomethine H  
Range : 5.0 — 80.0 mg/L (ppm)  
Reagent : WAK-B (C) K-1 (Liquid) , Tube  
Reaction time : 12 min. after drawing sample into the tube.

Cell : PACKTEST Square Cup  
Wavelength : 490 nm

### Procedure

1. Press **[B-C]**.
2. Press **[OK]** to switch to the photometry window.
3. Fill the Cell with the sample for 0.2 mL by using the small pipette. (Fig.1)
4. Add the K-1 reagent for 1.5 mL to the sample in the Cell by using the large pipette, attach the cap, and shake the Cell 2 to 3 times. (Fig.2)
5. Remove the cap of the Cell, set the Cell in the cell box and press **[Zero]**. (Fig.3)
6. Suck the whole amount of the sample in the Cell into the tube and press **[Start]** at the same time. (Fig.4)
7. Shake the tube in Step 6 by overturning it to right and left for 60 times in 1 minute. (Fig.5)
8. Return the solution in the tube to the Cell in a gentle manner, set it again in the cell box. (Fig.6)
9. After 12 minutes have elapsed, the concentration will be automatically displayed.

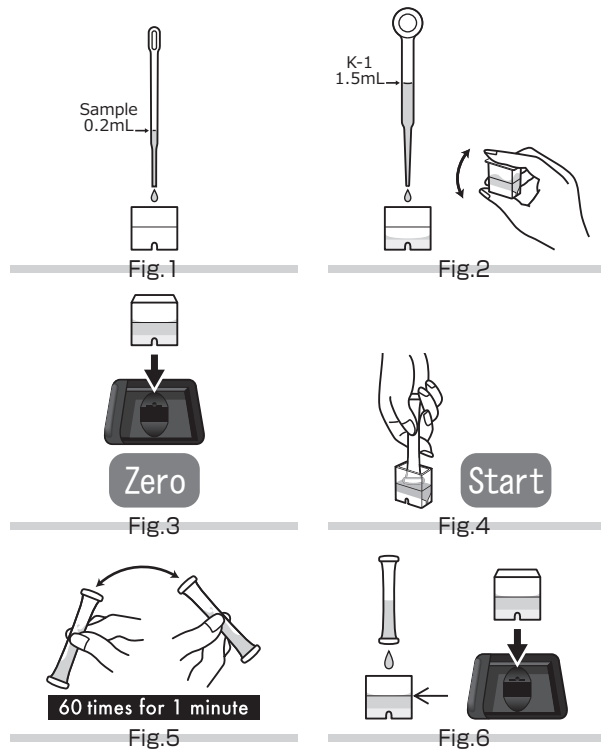

### Caution

1. In this method, the concentration of ionized borate (borax) is measured and it is converted into a boron concentration value. It is impossible to measure the concentration of fluoroborate ( $\text{BF}_4^-$ ).
2. Use the small pipette for sample after thoroughly cleaning it with pure water or cleaning its inside with the sample.
3. The optimum pH during color development is 6. If the pH of the sample is not within the range from 5 to 9, neutralize the sample with dilute sulfuric acid or dilute sodium hydroxide solution, etc.
4. Perform measurement with the sample temperature set to 20°C .  
If the sample temperature is other than 20°C , multiplying the measurement value by either of the following coefficients can implement correction.  
 $15^\circ\text{C} \cdots \times 0.95$       $25^\circ\text{C} \cdots \times 1.20$
5. Use of a measuring pipette or the like instead of the supplied pipette enables more accurate measurement.

### Influence of coexisting substance

The stored calibration curve has been created by using the standard solution. If the influence of other substance is considered, check the measurement value by comparing it with the official method or by standard addition method. The right chart is the list of interference data for acceptable level by adding each of the single substances to the standard solution.

Seawater does not affect the measurement. (However, ordinary seawater contains boron at 4 to 5 mg/L.)

$\leq 5000\text{mg/L.}$ : As (III) , $\text{Cl}^-$ , $\text{F}^-$ , $\text{I}^-$ , $\text{K}^+$ , $\text{Na}^+$ , $\text{NH}_4^+$ , $\text{NO}_2^-$ , $\text{NO}_3^-$ , $\text{PO}_4^{3-}$ , Phenol
$\leq 2500\text{mg/L.}$ : $\text{Mg}^{2+}$ , $\text{Mn}^{2+}$
$\leq 1000\text{mg/L.}$ : $\text{Ni}^{2+}$ , $\text{SO}_4^{2-}$ , $\text{Zn}^{2+}$
$\leq 500\text{mg/L.}$ : $\text{Ba}^{2+}$ , $\text{Ca}^{2+}$
$\leq 250\text{mg/L.}$ : $\text{Al}^{3+}$ , $\text{Cr}^{3+}$ , Anionic Surfactant
$\leq 100\text{mg/L.}$ : $\text{Cu}^{2+}$
$\leq 50\text{mg/L.}$ : $\text{CN}^-$ , Cr (VI) , Residual Chlorine
$\leq 25\text{mg/L.}$ : $\text{Fe}^{2+}$ , $\text{Sn}^{2+}$
$< 1\text{mg/L.}$ : $\text{Ag}^+$ , $\text{Fe}^{3+}$

### Information on reagent

Refer to the usage that comes with PACKTEST.  
The pH of the solution is about 6.

## B Boron

Color development: Light yellow → Yellow  
Method : Azomethine H  
Range : 0.50 — 6.00 mg/L (ppm)  
Reagent : WAK-B Tube  
Reaction time : 40 min. after drawing sample into the tube.

Cell : PACKTEST Square Cup  
Wavelength : 490 nm

### Procedure

1. Press **[B]**.
2. Press **[OK]** to switch to the photometry window.
3. Fill the Cell with the sample for 1.5 mL (up to line). (Fig.1)
4. Put the Cell in the cell box and press **[Zero]**. (Fig.2)
5. Suck the whole amount of the sample in the Cell into the tube and press **[Start]** at the same time. (Fig.3)
6. Shake the tube in Step 5 about 10 times. (If large orange lumps are left in the tube, further shake the tube.) (Fig.4)
7. Gently return the solution in the tube to the Cell, set it again in the cell box. (Fig.5)
8. After 40 minutes have elapsed, the concentration will be automatically displayed.

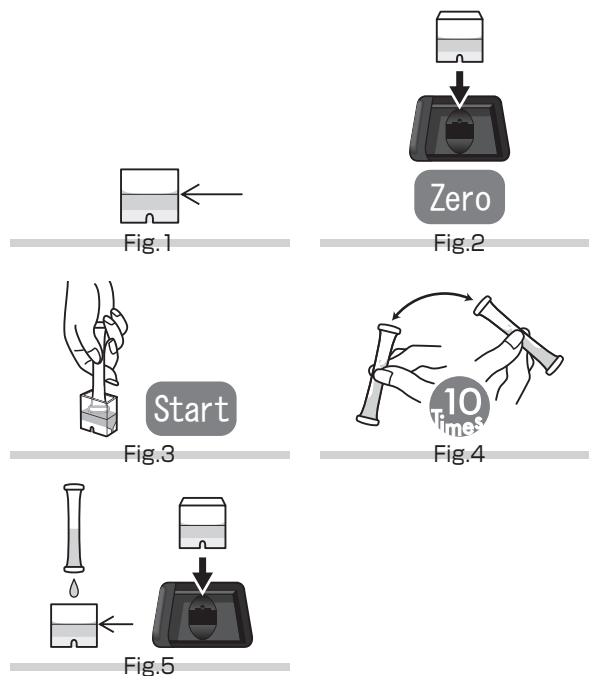

### Caution

1. In this method, the concentration of ionized borate (borax) is measured and it is converted into a boron concentration value. It is impossible to measure the concentration of fluoroborate ( $\text{BF}_4^-$ ).
2. The optimum pH during color development is 6. If the pH of the sample is not within the range from 5 to 9, neutralize the sample with dilute sulfuric acid or dilute sodium hydroxide solution, etc.
3. Perform measurement with the sample temperature set to 20°C.  
If the sample temperature is other than 20°C, multiplying the measurement value by either of the following coefficients can implement correction.  
15°C ··· ×0.95    25°C ··· ×1.25

### Influence of coexisting substance

The stored calibration curve has been created by using the standard solution. If the influence of other substance is considered, check the measurement value by comparing it with the official method or by standard addition method.

The right chart is the list of interference data for acceptable level by adding each of the single substances to the standard solution.

Seawater does not affect the measurement. (However, ordinary seawater contains boron at 4 to 5 mg/L.)

≤ 1000mg/L.: As (III),  $\text{Cl}^-$ ,  $\text{F}^-$ ,  $\text{I}^-$ ,  $\text{K}^+$ ,  $\text{Na}^+$ ,  $\text{NH}_4^+$ ,  $\text{NO}_2^-$ ,  $\text{NO}_3^-$ ,  $\text{PO}_4^{3-}$ , Phenol  
≤ 500mg/L.:  $\text{Mg}^{2+}$ ,  $\text{Mn}^{2+}$   
≤ 250mg/L.:  $\text{Ni}^{2+}$ ,  $\text{SO}_4^{2-}$ ,  $\text{Zn}^{2+}$   
≤ 100mg/L.:  $\text{Ba}^{2+}$ ,  $\text{Ca}^{2+}$   
≤ 50mg/L.:  $\text{Al}^{3+}$ ,  $\text{Cr}^{3+}$ , Anionic Surfactant  
≤ 25mg/L.:  $\text{Cu}^{2+}$   
≤ 10mg/L.:  $\text{CN}^-$ , Cr (VI), Residual Chlorine  
≤ 5mg/L.:  $\text{Fe}^{2+}$ ,  $\text{Sn}^{2+}$   
< 1mg/L.:  $\text{Ag}^+$ ,  $\text{Fe}^{3+}$

### Information on reagent

Refer to the usage that comes with PACKTEST.  
The pH of the solution is about 6.

## CI-500 Chloride (High Range)

Color development: Transparent → White Turbidity  
Method : Dilution and Turbidimetry with Silver Nitrate  
Range : 20 — 500 mg/L(ppm)  
Reagent : DPR-Cl R-1 (Dropper) , R-2 (Dropper)  
Reaction time : 3 min. after R-2 reagent is added.

Cell : PACKTEST Square Cup  
Wavelength : 615 nm

### Procedure

1. Press **[CI-500]**.
2. Press **[OK]** to switch to the photometry window.
3. Suck about 0.2mL of air into the supplied syringe, suck the sample in succession, and adjust the liquid level to the scale mark of 0.12mL. (Fig.1)
4. Pour the sample in the syringe into the Cell. (Fig.2)
5. Add pure water up to line of the Cell by using supplied pipette. (Fig.3)
6. Put the Cell in the cell box and press **[Zero]**. (Fig.4)
7. Add one droplet of the R-1 reagent, attach the cap, and shake the Cell 2 to 3 times. (Fig.5)
8. Add one droplet of the R-2 reagent, immediately attach the cap, and shake the Cell 2 to 3 times, and press **[Start]**. (Fig.6)
9. Remove the cap of the Cell, set the Cell in the cell box again. (Fig.7)
10. After 3 minutes have elapsed, the concentration will be automatically displayed.

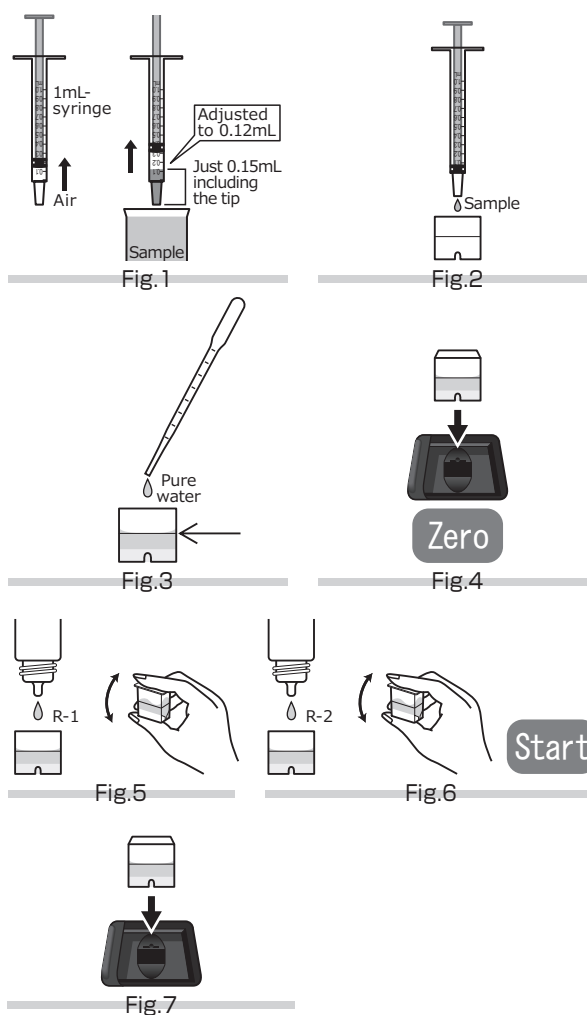

### Caution

1. Refer to "Cl Chloride".
2. In Step 5 of "Procedure", pure water is required. (Do not use tap water.)
3. Use of a measuring pipette or the like instead of the supplied syringe enables more accurate measurement.

### Influence of coexisting substance

The stored calibration curve has been created by using the standard solution. If the influence of other substance is considered, check the measurement value by comparing it with the official method or by standard addition method.

The right chart is the list of interference data for acceptable level by adding each of the single substances to the standard solution.

≤ 10000mg/L.: Al<sup>3+</sup>, B (III), Ca<sup>2+</sup>, Co<sup>2+</sup>, Cr<sup>3+</sup>, Cu<sup>2+</sup>, F<sup>-</sup>, Fe<sup>3+</sup>, K<sup>+</sup>,  
Mg<sup>2+</sup>, Mn<sup>2+</sup>, Na<sup>+</sup>, NH<sub>4</sub><sup>+</sup>, Ni<sup>2+</sup>, NO<sub>2</sub><sup>-</sup>, NO<sub>3</sub><sup>-</sup>, SO<sub>4</sub><sup>2-</sup>,  
Zn<sup>2+</sup>, Phenol  
≤ 5000mg/L.: Silica  
≤ 2000mg/L.: PO<sub>4</sub><sup>3-</sup>, Anionic Surfactant  
≤ 100mg/L.: Fe<sup>2+</sup>  
≤ 50mg/L.: Residual Chlorine  
≤ 10mg/L.: Ba<sup>2+</sup>, Cr (VI), I<sup>-</sup>, Mo (VI)  
< 1mg/L.: CN<sup>-</sup>

### Information on reagent

Refer to the usage supplied with "DPR-Cl".

The pH of the solution is almost same as the sample.

## Cl Chloride

Color development: Transparent → White Turbidity  
Method : Turbidimetry with Silver Nitrate  
Range : 2.0 – 50.0 mg/L(ppm)  
Reagent : DPR-Cl R-1 (Dropper) , R-2 (Dropper)  
Reaction time : 3 min. after R-2 reagent is added.

Cell : PACKTEST Square Cup  
Wavelength : 615 nm

### Procedure

1. Press **[Cl]**.
2. Press **[OK]** to switch to the photometry window.
3. Fill the Cell with the sample for 1.5 mL (up to line). (Fig.1)
4. Put the Cell in the cell box and press **[Zero]** . (Fig.2)
5. Add one droplet of the R-1 reagent, attach the cap, and shake the Cell 2 to 3 times. (Fig.3)
6. Add one droplet of the R-2 reagent, immediately attach the cap, and shake the Cell 2 to 3 times, and press **[Start]** . (Fig.4)
7. Remove the cap of the Cell, set the Cell in the cell box again. (Fig.5)
8. After 3 minutes have elapsed, the concentration will be automatically displayed.

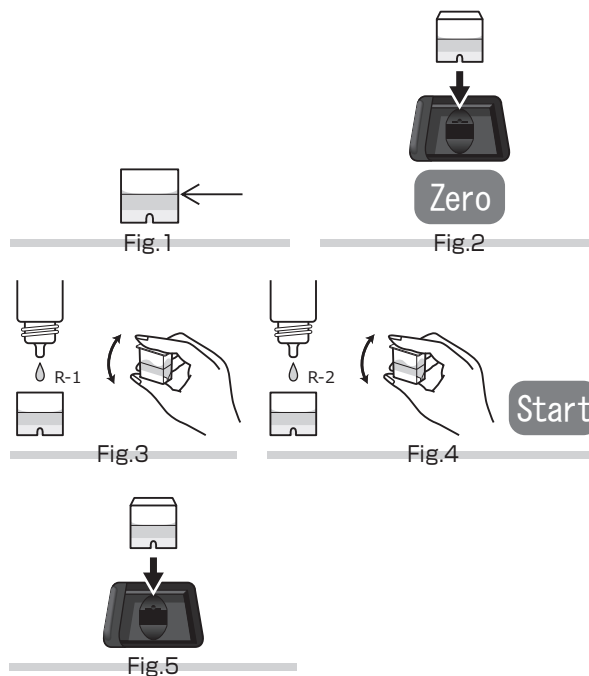

### Caution

1. In this method, the concentration of chloride ions ( $\text{Cl}^-$ ) in the sample is measured. If  $\text{Br}^-$  and  $\text{I}^-$  coexist, a positive measurement error could occur.
2. The chloride to be measured is not such chlorine for disinfection as contained in tap water or the like. To measure the concentration of chlorine for disinfection, refer to "ClO-DPD Residual Chlorine (Free)".
3. The optimum pH during color development is 9 or less. To an alkaline sample, add dilute sulfuric acid or the like so as to adjust the pH of the sample to 9 or less. (Do not use hydrochloric acid.)
4. Perform measurement with the sample temperature set to 20 to 25°C .  
If the sample temperature is not within the range, multiplying the measurement value by either of the following coefficients can implement correction.  
 $15^\circ\text{C} \cdots \times 1.3$        $30^\circ\text{C} \cdots \times 0.84$
5. Depending on the operation method, the results vary. In Step 6 of "Procedure", shake the Cell as soon as possible after R-2 reagent is added.
6. To set the Cell in the box, remove the cap. Wipe off water droplets before setting the Cell in the cell box.
7. As turbid substances attach to the Cell after measurement, thoroughly clean the Cell.

### Influence of coexisting substance

The stored calibration curve has been created by using the standard solution. If the influence of other substance is considered, check the measurement value by comparing it with the official method or by standard addition method. The right chart is the list of interference data for acceptable level by adding each of the single substances to the standard solution.

It is possible to measure seawater, but as it has a high concentration of chloride ions, dilution is necessary. (Approximately 1000 times in the case of artificial seawater)

$\leq 1000\text{mg/L}$ :  $\text{Al}^{3+}$ , B (III),  $\text{Ca}^{2+}$ ,  $\text{Co}^{2+}$ ,  $\text{Cr}^{3+}$ ,  $\text{Cu}^{2+}$ ,  $\text{F}^-$ ,  $\text{Fe}^{3+}$ ,  $\text{K}^+$ ,  
 $\text{Mg}^{2+}$ ,  $\text{Mn}^{2+}$ ,  $\text{Na}^+$ ,  $\text{NH}_4^+$ ,  $\text{Ni}^{2+}$ ,  $\text{NO}_2^-$ ,  $\text{NO}_3^-$ ,  $\text{SO}_4^{2-}$ ,  
 $\text{Zn}^{2+}$ , Phenol  
 $\leq 500\text{mg/L}$ : Silica  
 $\leq 200\text{mg/L}$ :  $\text{PO}_4^{3-}$ , Anionic Surfactant  
 $\leq 10\text{mg/L}$ :  $\text{Fe}^{2+}$   
 $\leq 5\text{mg/L}$ : Residual Chlorine  
 $\leq 1\text{mg/L}$ :  $\text{Ba}^{2+}$ , Cr (VI),  $\text{I}^-$ , Mo (VI)  
 $< 1\text{mg/L}$ :  $\text{CN}^-$

### Information on reagent

Refer to the usage supplied with "DPR-Cl".  
The pH of the solution is almost same as the sample.

## CIO-C Residual Chlorine (High Range)

Color development: None → Yellow → Orange → Red brown  
Method : Potassium Iodide  
Range : 2 – 500 mg/L(ppm)  
Reagent : WAK-CIO (C) Tube  
Reaction time : 1 min. after drawing sample into the tube.

Cell : PACKTEST Square Cup  
Wavelength : 470 nm, 600 nm

### Procedure

1. Press **[CIO-C]**.
2. Press **[OK]** to switch to the photometry window.
3. Fill the Cell with the sample for 1.5 mL (up to line). (Fig.1)
4. Put the Cell in the cell box and press **[Zero]**. (Fig.2)
5. Suck the whole amount of the sample in the Cell into the tube and press **[Start]** at the same time. (Fig.3)
6. Lightly shake the tube in Step 5 from 5 to 6 times, return the solution in the tube to the Cell in a gentle manner, set it again in the cell box. (Fig.4)
7. After 1 minute has elapsed, the concentration will be automatically displayed.

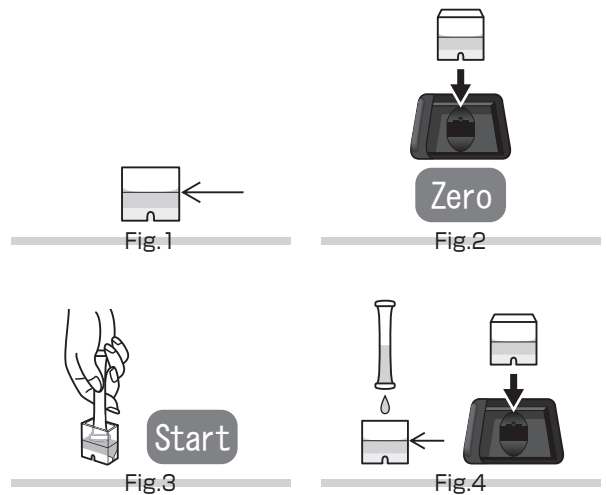

### Caution

1. In this method, the concentration of the total residual chlorine (free residual chlorine + combined residual chlorine) is measured.
2. This residual chlorine is chlorine for disinfection. To measure the concentration of chloride ions ( $\text{Cl}^-$ ) such as common salt, refer to "Cl Chloride".
3. The optimum pH during color development is 4. If the pH of the sample is not within the range from 3 to 9, neutralize the sample with dilute sulfuric acid or dilute sodium hydroxide solution, etc.
4. Perform measurement with the sample temperature set to 15 to 30°C.

### Influence of coexisting substance

The stored calibration curve has been created by using the standard solution. If the influence of other substance is considered, check the measurement value by comparing it with the official method or by standard addition method.

The right chart is the list of interference data for acceptable level by adding each of the single substances to the standard solution.

Seawater does not affect the measurement.

Reductive substances such as  $\text{Fe}^{2+}$  and  $\text{NO}_2^-$  consume residual chlorine.

$\text{NO}_2^-$  may serve as an oxidizer and may cause a positive measurement error.

Oxidizing substances such as hydrogen peroxide cause a positive measurement error.

$\leq 1000\text{mg/L}$ : $\text{Al}^{3+}$ , B (III), $\text{Ca}^{2+}$ , $\text{Cl}^-$ , $\text{F}^-$ , $\text{K}^+$ , $\text{Mg}^{2+}$ , $\text{Mn}^{2+}$ , Mo (VI), $\text{Na}^+$ , $\text{NH}_4^+$ , $\text{Ni}^{2+}$ , $\text{NO}_3^-$ , $\text{PO}_4^{3-}$ , $\text{SO}_4^{2-}$ , $\text{Zn}^{2+}$
$\leq 200\text{mg/L}$ : $\text{Ba}^{2+}$
$\leq 50\text{mg/L}$ : Cr (VI), Anionic Surfactant, Phenol
$\leq 20\text{mg/L}$ : $\text{Cr}^{3+}$
$\leq 5\text{mg/L}$ : $\text{Fe}^{3+}$
$\leq 2\text{mg/L}$ : $\text{Cu}^{2+}$

### Information on reagent

Refer to the usage that comes with PACKTEST.

The pH of the solution is about 4.

## CIO-DPD Residual Chlorine (Free)

Color development: None → Pink  
Method : N,N-diethyl-*p*-phenylenediamine sulfate  
Range : 0.05 — 3.00 mg/L(ppm)  
Reagent : WAK-CIO·DP Tube  
Reaction time : 1 min. after drawing sample into the tube.

Cell : PACKTEST Square Cup  
Wavelength : 552 nm, 532 nm, 670 nm

### Procedure

1. Press **[CIO-DPD]**.
2. Press **[OK]** to switch to the photometry window.
3. Fill the Cell with the sample for 1.5 mL (up to line). (Fig.1)
4. Put the Cell in the cell box and press **[Zero]**. (Fig.2)
5. Suck the whole amount of the sample in the Cell into the tube and press **[Start]** at the same time. (Fig.3)
6. Lightly shake the tube in Step 5 from 5 to 6 times, immediately return the solution in the tube to the Cell in a gentle manner, set it again in the cell box. (Fig.4)
7. After 1 minute has elapsed, the concentration will be automatically displayed.

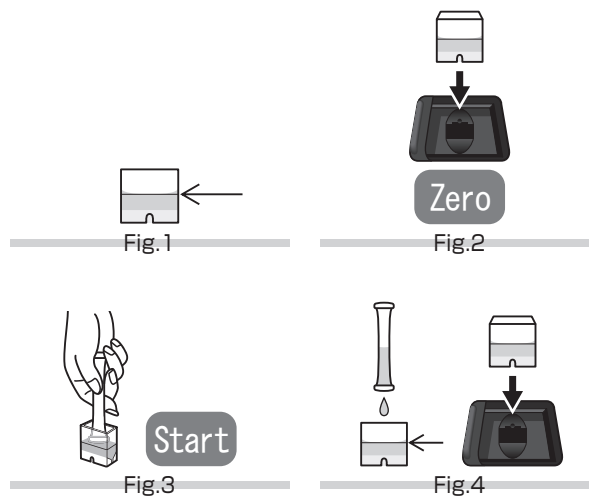

### Caution

1. In this method, the concentration of free residual chlorine in the sample is measured. To measure the concentration of the total residual chlorine (= free residual chlorine + combined residual chlorine), refer to "T-CIO Total Residual Chlorine".
2. This residual chlorine is chlorine for disinfection. To measure the concentration of chloride ions ( $\text{Cl}^-$ ) such as common salt, refer to "Cl Chloride".
3. The optimum pH during color development is 7. If the pH of the sample is not within the range from 5 to 9, neutralize the sample with dilute sulfuric acid or dilute sodium hydroxide solution, etc.
4. Perform measurement with the sample temperature set to 15 to 30°C.
5. When the concentration of residual chlorine is 20 mg/L or higher, the measurement value will be low. If high concentration is anticipated, dilute in advance and then perform measurement.

### Influence of coexisting substance

The stored calibration curve has been created by using the standard solution. If the influence of other substance is considered, check the measurement value by comparing it with the official method or by standard addition method.

The right chart is the list of interference data for acceptable level by adding each of the single substances to the standard solution.

Seawater does not affect the measurement.

Reductive substances such as  $\text{CN}^-$ ,  $\text{Fe}^{2+}$  and  $\text{NO}_2^-$  consume residual chlorine.

Oxidizing substances cause a positive measurement error.

As  $\text{NH}_4^+$  reacts with free residual chlorine to turn into combined residual chlorine, the amount of free residual chlorine reduces.

(The total residual chlorine remains the same.)

If  $\text{I}^-$  coexists, combined residual chlorine will also be measured.

$\leq 1000\text{mg/L}$ : $\text{Ca}^{2+}$ , $\text{Cl}^-$ , $\text{F}^-$ , $\text{K}^+$ , Mo (VI), $\text{Na}^+$ , $\text{Ni}^{2+}$ , $\text{PO}_4^{3-}$ , $\text{SO}_4^{2-}$ , $\text{Zn}^{2+}$
$\leq 500\text{mg/L}$ : $\text{Al}^{3+}$ , B (III), $\text{Cr}^{3+}$ , $\text{Mg}^{2+}$
$\leq 250\text{mg/L}$ : $\text{Mn}^{2+}$
$\leq 100\text{mg/L}$ : $\text{NO}_3^-$ , Phenol
$\leq 25\text{mg/L}$ : $\text{Co}^{2+}$
$\leq 10\text{mg/L}$ : $\text{Fe}^{3+}$
$\leq 5\text{mg/L}$ : $\text{Ba}^{2+}$
$\leq 1\text{mg/L}$ : $\text{Cu}^{2+}$
$< 1\text{mg/L}$ : $\text{Ag}^+$ , Cr (VI)

### Information on reagent

Refer to the usage that comes with PACKTEST.

The pH of the solution is about 7.

## T-CIO Total Residual Chlorine

Color development: None → Pink  
Method : N,N-diethyl-*p*-phenylenediamine sulfate  
Range : 0.05 — 3.00 mg/L(ppm)  
Reagent : WAK-T·CIO Tube  
Reaction time : 2 min. after drawing sample into the tube.

Cell : PACKTEST Square Cup  
Wavelength : 552 nm, 532 nm, 670 nm

### Procedure

1. Press **[T-CIO]**.
2. Press **[OK]** to switch to the photometry window.
3. Fill the Cell with the sample for 1.5 mL (up to line). (Fig.1)
4. Put the Cell in the cell box and press **[Zero]**. (Fig.2)
5. Suck the whole amount of the sample in the Cell into the tube and press **[Start]** at the same time. (Fig.3)
6. Lightly shake the tube in Step 5 from 5 to 6 times, immediately return the solution in the tube to the Cell in a gentle manner, set it again in the cell box. (Fig.4)
7. After 2 minutes have elapsed, the concentration will be automatically displayed.

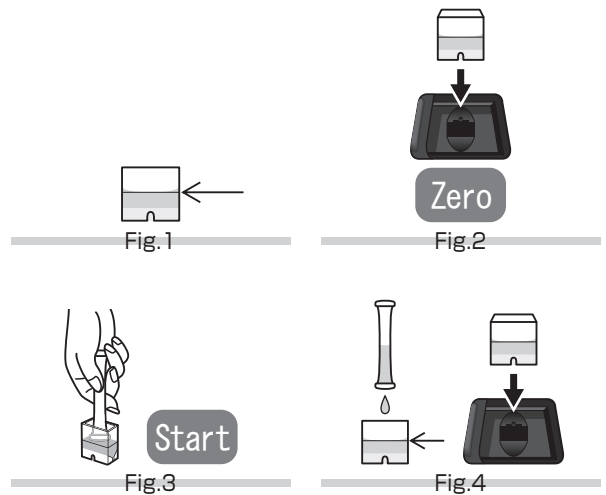

### Caution

1. In this method, the concentration of total residual chlorine in the sample is measured.  
To measure the concentration of free residual chlorine (= total residual chlorine - combined residual chlorine), refer to "CIO-DPD Residual Chlorine (Free)".
2. Total residual chlorine is chlorine for disinfection. To measure the concentration of chloride ions ( $\text{Cl}^-$ ) such as common salt, refer to "Cl Chloride".
3. The optimum pH during color development is 7. If the pH of the sample is not within the range from 5 to 9, neutralize the sample with dilute sulfuric acid or dilute sodium hydroxide solution, etc.
4. Perform measurement with the sample temperature set to 15 to 30°C.
5. When the concentration of residual chlorine is 20 mg/L or higher, the measurement value will be low. If high concentration is anticipated, dilute in advance and then perform measurement.

### Influence of coexisting substance

The stored calibration curve has been created by using the standard solution. If the influence of other substance is considered, check the measurement value by comparing it with the official method or by standard addition method.

The right chart is the list of interference data for acceptable level by adding each of the single substances to the standard solution.

Seawater does not affect the measurement.  
Reductive substances such as  $\text{CN}^-$ ,  $\text{Fe}^{2+}$  and  $\text{NO}_2^-$  consume residual chlorine.  
Oxidizing substances cause a positive measurement error.

≤ 1000mg/L.:  $\text{Ca}^{2+}$ ,  $\text{Cl}^-$ ,  $\text{F}^-$ ,  $\text{I}^-$ ,  $\text{K}^+$ ,  $\text{Mo (VI)}$ ,  $\text{Na}^+$ ,  $\text{Ni}^{2+}$ ,  $\text{PO}_4^{3-}$ ,  $\text{SO}_4^{2-}$ ,  $\text{Zn}^{2+}$   
≤ 500mg/L.:  $\text{Al}^{3+}$ ,  $\text{B (III)}$ ,  $\text{Cr}^{3+}$ ,  $\text{Mg}^{2+}$   
≤ 250mg/L.:  $\text{Mn}^{2+}$   
≤ 100mg/L.:  $\text{NO}_3^-$ , Phenol  
≤ 25mg/L.:  $\text{Co}^{2+}$   
≤ 10mg/L.:  $\text{Fe}^{3+}$   
≤ 5mg/L.:  $\text{Ba}^{2+}$   
≤ 1mg/L.:  $\text{Cu}^{2+}$   
< 1mg/L.:  $\text{Ag}^+$ ,  $\text{Cr (VI)}$

### Information on reagent

Refer to the usage that comes with PACKTEST.  
The pH of the solution is about 7.



## ClO<sub>2</sub> Chlorine Dioxide

Color development: None → Pink  
Method : N,N-diethyl-*p*-phenylenediamine sulfate with Glycine  
Range : 0.20 — 6.00 mg/L(ppm)  
Reagent : WAK-ClO<sub>2</sub> K-1 (Dropper) , Tube  
Reaction time : 30 sec. after drawing sample into the tube.

Cell : PACKTEST Square Cup  
Wavelength : 552 nm, 532 nm, 670 nm

### Procedure

1. Press **[ClO<sub>2</sub>]**.
2. Press **[OK]** to switch to the photometry window.
3. Fill the Cell with the sample for 1.5 mL (up to line). (Fig.1)
4. Put the Cell in the cell box and press **[Zero]**. (Fig.2)
5. Add two droplets of K-1 reagent, attach the cap, and shake the Cell 2 to 3 times. (Fig.3)
6. Suck the whole amount of the sample in the Cell into the tube and press **[Start]** at the same time. (Fig.4)
7. Lightly shake the tube in Step 6 from 5 to 6 times, immediately return the solution in the tube to the Cell in a gentle manner, set it again in the cell box. (Fig.5)
8. After 30 seconds have elapsed, the concentration will be automatically displayed.

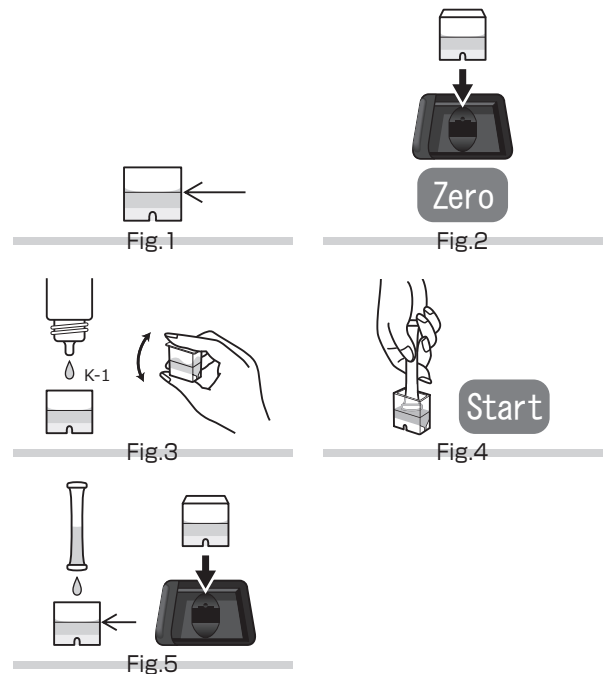

### Caution

1. Strictly observe the reaction time. After the reaction time has elapsed, the color development will be intensified. In particular, in the case where residual chlorine, chlorite ions, chlorate ions, etc. are considered to coexist, be sure to strictly observe the reaction time.
2. The optimum pH during color development is 7. If the pH of the sample is not within the range from 5 to 9, neutralize the sample with dilute sulfuric acid or dilute sodium hydroxide solution, etc.
3. Perform measurement with the sample temperature set to 15 to 30°C .
4. When the concentration of chlorine dioxide is 40 mg/L or higher, the measurement value will be low. If high concentration is anticipated, dilute in advance and then perform measurement.

### Influence of coexisting substance

The stored calibration curve has been created by using the standard solution. If the influence of other substance is considered, check the measurement value by comparing it with the official method or by standard addition method.

The right chart is the list of interference data for acceptable level by adding each of the single substances to the standard solution.

Seawater does not affect the measurement.

Reductive substances such as CN<sup>-</sup>, Fe<sup>2+</sup>, and NO<sub>2</sub><sup>-</sup> consume chlorine dioxide. Oxidizing substances cause a positive measurement error.

If I<sup>-</sup> coexists, residual chlorine will also be measured.

<p>≤ 1000mg/L.: B (III) , Ca<sup>2+</sup> , Cl<sup>-</sup> , Cr<sup>3+</sup> , F<sup>-</sup> , I<sup>-</sup> , K<sup>+</sup> , Mg<sup>2+</sup> , Mn<sup>2+</sup> , Na<sup>+</sup> , Ni<sup>2+</sup> , NO<sub>3</sub><sup>-</sup> , PO<sub>4</sub><sup>3-</sup> , SO<sub>4</sub><sup>2-</sup> , Zn<sup>2+</sup></p> <p>≤ 500mg/L.: Al<sup>3+</sup> , Chlorite ion , Chlorate ion</p> <p>≤ 250mg/L.: NH<sub>4</sub><sup>+</sup></p> <p>≤ 50mg/L.: Mo (VI)</p> <p>≤ 25mg/L.: Co<sup>2+</sup></p> <p>≤ 10mg/L.: Fe<sup>3+</sup> , Phenol</p> <p>≤ 5mg/L.: Ba<sup>2+</sup></p> <p>≤ 1mg/L.: Cu<sup>2+</sup> , Residual Chlorine</p> <p>&lt; 1mg/L.: Ag<sup>+</sup> , Cr (VI) , Fe<sup>2+</sup> , NO<sub>2</sub><sup>-</sup></p>
--

### Information on reagent

Refer to the usage that comes with PACKTEST.

The pH of the solution is about 7.

## NaClO<sub>2</sub> Sodium Chlorite

Color development: None → Yellow → Orange → Red brown  
Method : Potassium Iodide  
Range : 2 — 500 mg/L(ppm)  
Reagent : WAK-NaClO<sub>2</sub> K-1 (Dropper) , Tube  
Reaction time : 1 min. after drawing sample into the tube.

Cell : PACKTEST Square Cup  
Wavelength : 470 nm, 600 nm

### Procedure

1. Press **[NaClO<sub>2</sub>]**
2. Press **[OK]** to switch to the photometry window.
3. Fill the Cell with the sample for 1.5 mL (up to line). (Fig.1)
4. Put the Cell in the cell box and press **[Zero]**. (Fig.2)
5. Add four droplets of K-1 reagent. (Fig.3)
6. Immediately suck the whole amount of the sample in the Cell into the tube and press **[Start]** at the same time. (Fig.4)
7. Lightly shake the tube in Step 6 from 5 to 6 times, return the solution in the tube to the Cell in a gentle manner, set it again in the cell box. (Fig.5)
8. After 1 minute has elapsed, the concentration will be automatically displayed.

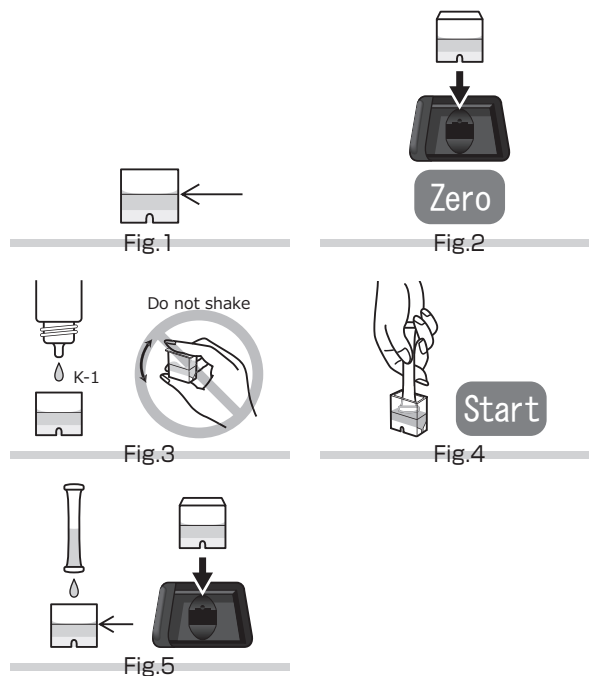

### Caution

1. In this method, the concentration of residual chlorine and chlorine dioxide is also measured.
2. As chlorine gas may be generated during measurement, be sure to perform measurement while ventilating the air.
3. The optimum pH during color development is 1. Neutralize a sample of pH 10 or greater with dilute sulfuric acid.
4. Perform measurement with the sample temperature set to 15 to 30°C.
5. After the K-1 reagent is added in Step 5 of "Procedure", do not shake the Cell, but immediately suck the sample into the tube. If the Cell is shaken or it takes time before the sample is sucked, the result may become low.

### Influence of coexisting substance

The stored calibration curve has been created by using the standard solution. If the influence of other substance is considered, check the measurement value by comparing it with the official method or by standard addition method. The right chart is the list of interference data for acceptable level by adding each of the single substances to the standard solution.

Seawater and tap water do not affect the measurement.

The residual chlorine and chlorine dioxide also make color development and cause positive error. Oxidizing substances such as hydrogen peroxide cause a positive measurement error. Reductive substances such as Fe<sup>2+</sup> and NO<sub>2</sub><sup>-</sup> consume sodium chlorite. NO<sub>2</sub><sup>-</sup> may serve as an oxidizer and may cause a positive measurement error.

When the sample contains starch, the color may develop to brown to black, disabling measurement.

≤ 1000mg/L.: Al <sup>3+</sup> , B (III), Ca <sup>2+</sup> , F <sup>-</sup> , I <sup>-</sup> , K <sup>+</sup> , Mg <sup>2+</sup> , Mn <sup>2+</sup> , Mo (VI), Na <sup>+</sup> , NH <sub>4</sub> <sup>+</sup> , Ni <sup>2+</sup> , NO <sub>3</sub> <sup>-</sup> , PO <sub>4</sub> <sup>3-</sup> , SO <sub>4</sub> <sup>2-</sup> , Zn <sup>2+</sup> , Amino acid, Glucose, Phenol, Silica, Sodium Chlorate
≤ 100mg/L.: Anionic Surfactant
≤ 20mg/L.: Albumin
≤ 10mg/L.: Ba <sup>2+</sup> , Starch
≤ 5mg/L.: Cu <sup>2+</sup> , Fe <sup>3+</sup>
≤ 1mg/L.: Fe <sup>2+</sup> , Residual Chlorine
< 1mg/L.: Cr (VI)

### Information on reagent

Refer to the usage that comes with PACKTEST.

The pH of K-1 reagent and the solution is about 1.

## NaClO<sub>2</sub>-D Sodium Chlorite (Low Range)

Color development: None → Pink

Method : Potassium iodide and DPD method

Range : 0.10 — 2.00 mg/L (ppm)

Reagent : WAK-NaClO<sub>2</sub> (D) , K-1 (Small Pack) , K-2 (Dropper) , K-3 (Dropper) , Tube

Reaction time : 1 min. after drawing sample into the tube.

Cell : PACKTEST Square Cup

Wavelength : 552 nm, 532 nm, 670 nm

### Procedure

1. Press **[NaClO<sub>2</sub>-D]**.
2. Press **[OK]** to switch to the photometry window.
3. Fill the Cell with the sample for 1.5 mL (up to line). (Fig.1)
4. Put the Cell in the cell box and press **[Zero]**. (Fig.2)
5. Add the K-1 reagent. (Fig.3)
6. Add one droplet of K-2 reagent, attach the cap, and shake the Cell 10 times. (Fig.4)
7. Add two droplets of K-3 reagent. (Fig.5)
8. Suck the whole amount of the sample in the Cell into the tube and press **[Start]** at the same time. (Fig.6)
9. Lightly shake the tube in Step 8 from 5 to 6 times, immediately return the solution in the tube to the Cell in a gentle manner, set it again in the cell box. (Fig.7)
10. After 1 minute has elapsed, the concentration will be automatically displayed.

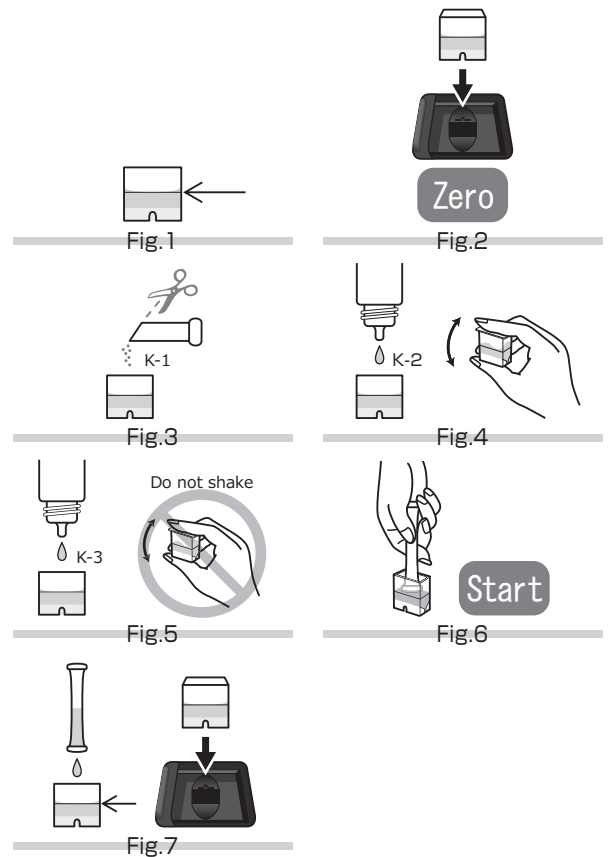

### When separately measuring the concentration of sodium chlorite and residual chlorine (0.5 mg/L or less)

- ① Press **[NaClO<sub>2</sub>-D]**.
- ② Press **[OK]** to switch to the photometry window.
- ③ Fill the Cell with the sample for 1.5 mL (up to line). (Fig.8)
- ④ Suck the whole amount of the sample in the Cell into the tube of PACKTEST Total Residual Chlorine (WAK-T-ClO) and then lightly shake the tube 5 to 6 times.  
Develop the color of the total residual chlorine. (At this point, the color of the sodium chlorite will not be developed.)(Fig.9)
- ⑤ Return the solution in the tube to the Cell, put the Cell in the cell box, and press **[Zero]**. (Fig.10)
- ⑥ Take the Cell out of the cell box, empty it, and clean it with pure water or the sample. (Fig.11)
- ⑦ Fill the Cell in ⑥ with the sample for 1.5 mL (up to line). (Fig.12)
- ⑧ From this step onwards, perform measurement by following in Step 5 of "Procedure".

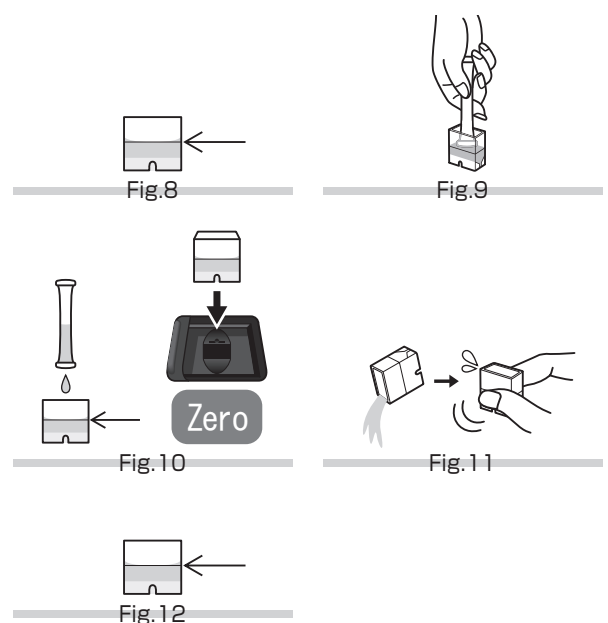

## Caution

1. In this method, the concentration of residual chlorine (hypochlorous acid, etc.) and chlorine dioxide is also measured.  
To separately measure the concentration of sodium chlorite and residual chlorine, refer to "When separately measuring the concentration of sodium chlorite and residual chlorine (0.5 mg/L or less)." In this case, separately prepare the PACKTEST Total Residual Chlorine (WAK-T·ClO). However, this cannot be applied in the case where residual chlorine of 0.5 mg/L or more coexists.
2. As chlorine gas may be generated during measurement, be sure to perform measurement while ventilating the air.
3. The pH as of after adding K-2 reagent is approx. 1. The pH as of during color development is approx. 5. If the pH of the sample is not within the range from 2 to 9, perform measurement after neutralizing the sample with dilute sulfuric acid or dilute sodium hydroxide solution, etc. However, extract by 9 mmol/L sodium carbonate solution can be measured without pH adjustment.
4. Perform measurement with the sample temperature set to 15 to 30°C .
5. When the concentration of sodium chlorite is 10 mg/L or higher, the measurement value will be low. If high concentration is anticipated, dilute in advance and then perform measurement.

## Influence of coexisting substance

The stored calibration curve has been created by using the standard solution. If the influence of other substance is considered, check the measurement value by comparing it with the official method or by standard addition method.

The right chart is the list of interference data for acceptable level by adding each of the single substances to the standard solution.

Seawater does not affect the measurement.

The color is developed by the residual chlorine contained in the tap water. The residual chlorine and chlorine dioxide also make the same color development.

The color is also developed by oxidizing substances such as hydrogen peroxide.

Reductive substances such as  $\text{Fe}^{2+}$  and  $\text{NO}_2^-$  consume sodium chlorite.  $\text{NO}_2^-$  may serve as an oxidizer and may develop its color.

$\leq 1000\text{mg/L}$ ;	$\text{Al}^{3+}$ , B (III), $\text{Ca}^{2+}$ , $\text{Cl}^-$ , $\text{F}^-$ , $\text{I}^-$ , $\text{K}^+$ , $\text{Mg}^{2+}$ , $\text{Mn}^{2+}$ , Mo (VI), $\text{Na}^+$ , $\text{NH}_4^+$ , $\text{Ni}^{2+}$ , $\text{NO}_3^-$ , $\text{PO}_4^{3-}$ , $\text{SO}_4^{2-}$ , $\text{Zn}^{2+}$ , Albumin, Sodium Chlorate, Citric Acid, Glycine, Glucose, Glutamic Acid, Tartaric Acid, Silica, Starch, Phenol
$\leq 500\text{mg/L}$ ;	$\text{Co}^{2+}$
$\leq 50\text{mg/L}$ ;	Anionic Surfactant
$\leq 10\text{mg/L}$ ;	$\text{Fe}^{3+}$
$\leq 2\text{mg/L}$ ;	$\text{Cu}^{2+}$ , Cationic Surfactant
$< 1\text{mg/L}$ ;	Cr (VI), $\text{Fe}^{2+}$ , $\text{NO}_2^-$ , $\text{SO}_3^{2-}$ , Ascorbic Acid, Residual Chlorine, Hydrogen Peroxide, Chlorine Dioxide

## Information on reagent

Refer to the usage that comes with PACKTEST.

The pH as of after adding K-2 reagent is 1.

The pH as of after adding K-3 reagent and the solution is 5.

## CN-2 Free Cyanide

Color development: None → (Red) → Blue  
Method : 4-Pyridinecarboxylic Acid  
Range : 0.01 — 1.00 mg/L(ppm)  
Reagent : WAK-CN-2 K-1 (Small Pack) , Tube  
Reaction time : 10 min. after drawing sample into the tube.

Cell : PACKTEST Square Cup  
Wavelength : 607 nm, 535 nm, 680 nm

### Procedure

1. Press **[CN-2]**.
2. Press **[OK]** to switch to the photometry window.
3. Fill the Cell with the sample for 1.5 mL (up to line). (Fig.1)
4. Put the Cell in the cell box and press **[Zero]**. (Fig.2)
5. Add the K-1 reagent, attach the cap, and shake the Cell 5 to 6 times. (Fig.3)
6. Suck the whole amount of the sample in the Cell into the tube and press **[Start]** at the same time. (Fig.4)
7. Lightly shake the tube in Step 6 about 10 times. (Fig.5)
8. Immediately return the solution in the tube to the Cell in a gentle manner, set it again in the cell box. (Fig.6)
9. After 10 minutes have elapsed, the concentration will be automatically displayed.

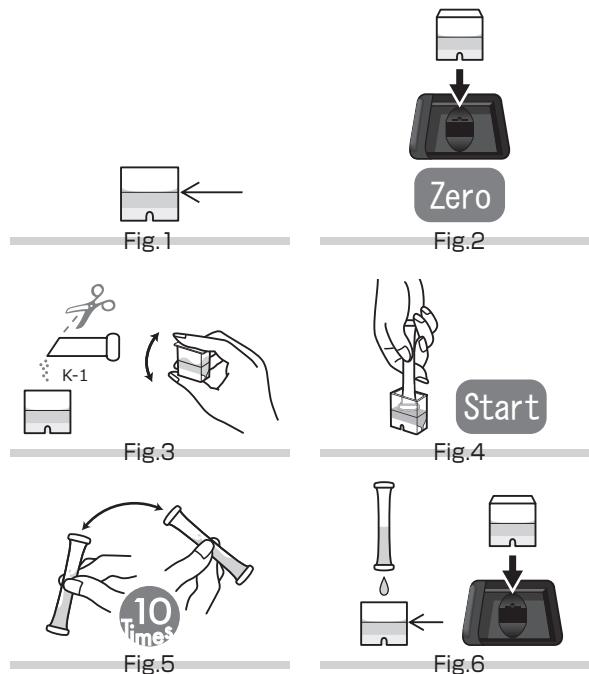

### Caution

1. In this method, the concentration of free cyanide (mainly cyanide ions ( $\text{CN}^-$ ) and cyanogen chloride ( $\text{CNCl}$ )) in the sample is measured. To measure the concentration of total cyanide including iron cyano complex, etc. refer to "CN<sup>-</sup>-D Total Cyanide (Low Range)" and "CN<sup>-</sup> Total Cyanide".
2. The optimum pH during color development is 6. If the pH of the sample is not within the range from 5 to 12, neutralize the sample with dilute sulfuric acid or dilute sodium hydroxide solution, etc.
3. After the tube is shaken in Step 7 of "Procedure", immediately and gently return the solution in the tube to the Cell. If you shake the tube excessively or take time before returning the solution, turbid may be generated.
4. Perform measurement with the sample temperature set to 20 to 30°C .

### Influence of coexisting substance

The stored calibration curve has been created by using the standard solution. If the influence of other substance is considered, check the measurement value by comparing it with the official method or by standard addition method.  
The right chart is the list of interference data for acceptable level by adding each of the single substances to the standard solution.

So far, only some thiocyanogens and ethylene amines (tetraethylenepentamine and pentaethylene hexamine) are erroneously detected.

If a strong oxidizing substance such as residual chlorine or a reductive substance such as sulfite exists, a negative error occurs. It is not possible to measure seawater.

If the sample is industrial wastewater or the like that contains interfering substance, conduct pretreatment by distillation/ventilation method or others.

<p>≤ 100mg/L.: As (III) , B (III) , <math>\text{Cl}^-</math> , <math>\text{F}^-</math> , <math>\text{K}^+</math> , <math>\text{Mg}^{2+}</math> , Mo (VI) , <math>\text{Na}^+</math> , <math>\text{NH}_4^+</math> , <math>\text{NO}_3^-</math> , <math>\text{PO}_4^{3-}</math> , <math>\text{SO}_4^{2-}</math> , EDTA , Phenol</p> <p>≤ 200mg/L.: <math>\text{NO}_2^-</math> , <math>\text{Zn}^{2+}</math></p> <p>≤ 100mg/L.: <math>\text{Ca}^{2+}</math> , Ascorbic Acid , Anionic Surfactant , Silica</p> <p>≤ 50mg/L.: <math>\text{Al}^{3+}</math> , <math>\text{Cr}^{3+}</math> , Cr (VI)</p> <p>≤ 20mg/L.: <math>\text{Cu}^{2+}</math></p> <p>≤ 10mg/L.: <math>\text{Ba}^{2+}</math> , <math>\text{Fe}^{2+}</math> , <math>\text{Fe}^{3+}</math></p> <p>≤ 5mg/L.: Residual Chlorine</p> <p>≤ 1mg/L.: Formaldehyde</p> <p>&lt; 1mg/L.: <math>\text{Co}^{2+}</math> , <math>\text{I}^-</math> , <math>\text{Mn}^{2+}</math> , <math>\text{Ni}^{2+}</math> , <math>\text{SCN}^-</math> , <math>\text{SO}_3^{2-}</math> , some kinds of ethylene amine , Cationic Surfactant</p>
--

### Information on reagent

Refer to the usage that comes with PACKTEST.  
The pH of the solution is about 6.

## CN<sup>-</sup> Total Cyanide

Color development: Yellow → Orange → Brown

Method : Distillation and Picric acid

Range : 0.1 — 3.0 mg/L(ppm)

Reagent : LR-CN<sup>-</sup> No.46 R-1 (Powder) , R-2 (Pack)

Reaction time : 0 min.

Additional tool : Water Analysis Set: Total Cyanide (Model: WA-CN<sup>-</sup>)

Usage : Read the instruction supplied with "Water Analysis Set: Total Cyanide".

Cell : PACKTEST Square Cup

Wavelength : 540 nm

### Procedure

1. Press **[CN<sup>-</sup>]**.
2. Press **[OK]** to switch to the photometry window.
3. Fill the Cell with pure water for 1.5 mL (up to line). (Fig.1)
4. Put the Cell in the cell box and press **[Zero]**. (Fig.2)
5. Take out the Cell, discard the pure water, and pour 1.5 mL of the solution that has been adjusted to 25 mL through distillation and color development with the Water Analysis Set: Total Cyanide to the same Cell. (Fig.3)
6. Set the Cell in the cell box again and press **[Start]**. (Fig.4)
7. The concentration will be automatically displayed.

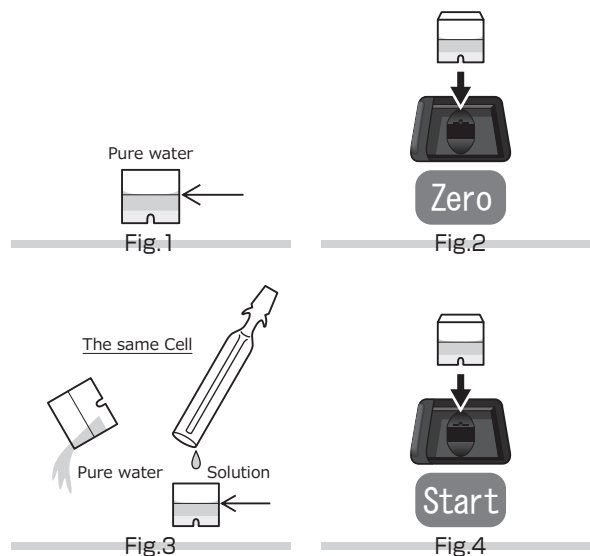

### Caution

1. As the glass portion of the distiller becomes hot during distillation, be careful not to get burned.
2. If you use dilute sulfuric acid instead of R-1 reagent, be sure to put a boiling stone in the flask to avoid bumping in it.
3. Sufficiently ventilate the room during distillation.

### Influence of coexisting substance

Refer to the instruction supplied with "Water Analysis Set: Total Cyanide."

### Information on reagent

Refer to the enclosed paper to the reagent.

The pH of the sample solution as of after addition of R-1 reagent is about 2.

The pH of the solution as of after addition of R-2 reagent is about 12.

Note that if cyanide is detected at a high concentration, neutralizing it causes cyanogen gas to be emitted.

## CN<sup>-</sup>-D Total Cyanide (Low Range)

Color development: None → (Red) → Blue

Method : Distillation and 4-Pyridinecarboxylic Acid - Pyrazolone

Range : 0.005 — 0.150 mg/L(ppm)

Reagent : LR-CN-B No.14B R-1 (Small Pack) , R-2 (Pack)

Reaction time : 20 min. after R-2 reagent is added.

Additional tool : Water Analysis Set: Total Cyanide (Low Range) (Model: WA-CN<sup>-</sup>(L))

Usage : Read the instruction supplied with "Water Analysis Set: Total Cyanide (Low Range)".

Cell : PACKTEST Square Cup

Wavelength : 638 nm, 590 nm

### Procedure

1. Press **[CN<sup>-</sup>-D]**.
2. Press **[OK]** to switch to the photometry window.
3. Fill the Cell with pure water for 1.5 mL (up to line). (Fig.1)
4. Put the Cell in the cell box and press **[Zero]**. (Fig.2)  
Discard the pure water in the Cell.
5. Add the R-1 reagent to the Round Cell containing the solution as explained in Step ⑦ of "Usage" of "Water Analysis Set: Total Cyanide (Low Range)". (Fig.3)
6. Tightly attach the cap, shake the Round Cell about 10 times, and wait for 3 minutes. (Fig.4)
7. Add the R-2 reagent to the Round Cell, press **[Start]**, tightly attach the cap, and immediately shake the Round Cell strongly more than 60 times in 30 seconds. (Fig.5)
8. Within 20 minutes, pour the solution in the Round Cell for 1.5 mL into the Cell that has gone through zero adjustment (up to line) and put the Cell in the cell box. (Fig.6)
9. After 20 minutes have elapsed, the concentration will be automatically displayed.

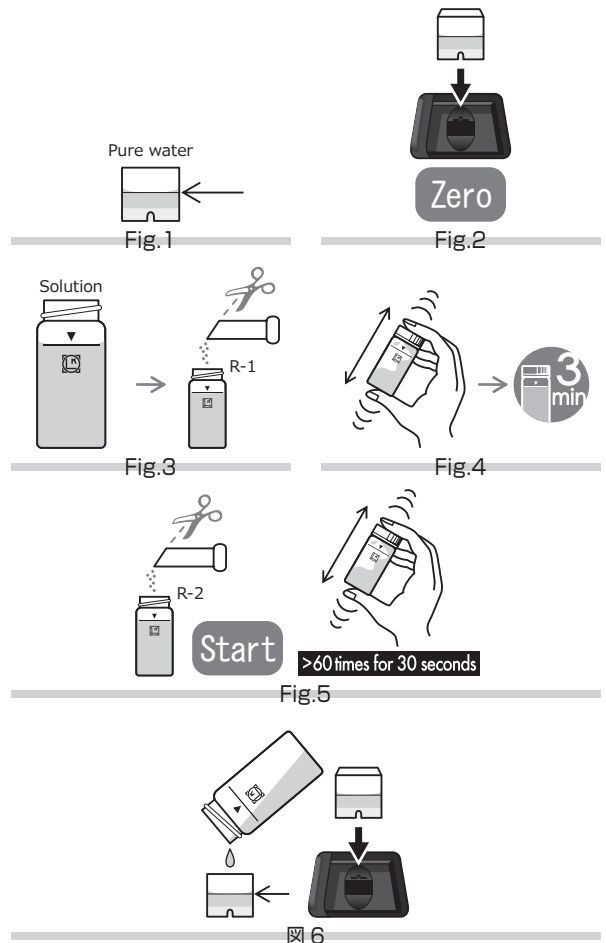

### CAUTION

1. Perform measurement with the solution temperature set to 15 to 30°C.
2. As the R-2 reagent dissolves only partially, after shaking the Round Cell in Step 6.

### Influence of coexisting substance

Refer to the instruction supplied with "Water Analysis Set: Total Cyanide (Low Range)".

### Information on reagent

Refer to the enclosed paper to the reagent.  
The pH of the solution is about 7.

## COD COD with $\text{KMnO}_4$

Color development: Red purple → Green

Method : Oxidation by potassium permanganate in alkaline

Range : 2.0 – 10.0 mg/L(ppm)

Reagent : LR-COD-B No.44 R-1 (Liquid) , R-2 (Pack) , Neutralizer (Dropper)

Reaction time : 10 min. after R-2 reagent is added.

Cell : PACKTEST Square Cup

Wavelength : 525 nm

### Procedure

1. Press **[COD]**.
2. Press **[OK]** to switch to the photometry window.
3. Fill the Cell with the sample for 1.5 mL (up to line) and fill the Round Cell with the sample for 25 mL (up to white line). (Fig.1)
4. Put the Cell in the cell box and press **[Zero]** . Discard the sample in the Cell. (Fig.2)
5. Add 0.5 mL of R-1 reagent into the Round Cell using the supplied syringe, tightly attach the cap, and stir the solution 5 to 6 times. (Fig.3)
6. Add the R-2 reagent into the Round Cell and press **[Start]**. (Fig.4)
7. Tightly attach the cap and shake the Round Cell strongly for 20 seconds. (Fig.5)
8. Within 10 minutes, pour 1.5 mL of the solution in the Round Cell into the Cell that has gone through zero adjustment, and put the Cell in the cell box. (At this point, clean the Cell with the solution contained in the Round Cell.)(Fig.6)
9. After 10 minutes have elapsed, the concentration will be automatically displayed.
10. Dispose of the wastewater in the Round Cell as of after measurement by adding about 8 droplets (0.5 mL) of neutralizer to it and confirming that it has become approximately neutral.

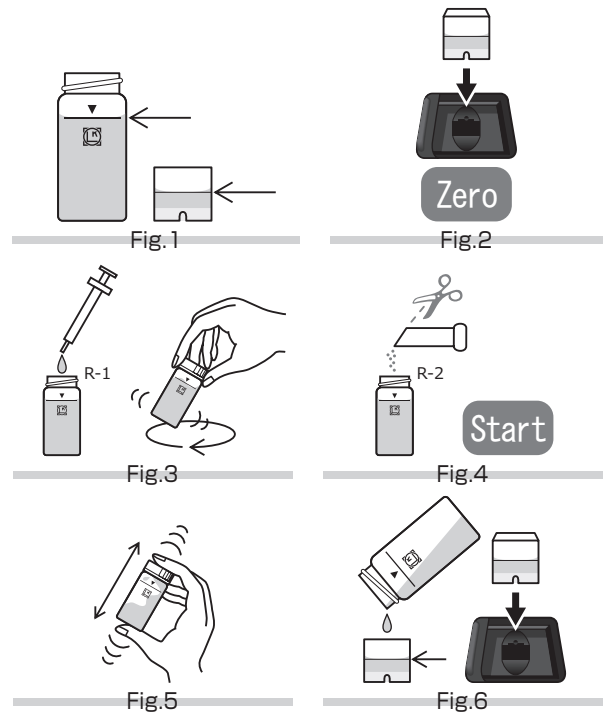

### CAUTION

1. The optimum pH during color development is 12 or more. To an acid sample, add dilute sodium hydroxide solution or the like so as to adjust the pH of the sample to 6 or more.
2. Perform measurement with the sample temperature set to 15 to 25°C .
3. Before filling the Cell with the solution in the measurement procedure Steps 8, rinse the Cup with the solution 2 to 3 times.
4. It is not possible to measure seawater.

### Positioning of this measurement method with respect to JIS method

In Japan, the potassium permanganate method ( $\text{COD}_{\text{Mn}}$ ) at 100°C for 30 minutes according to JIS K 0102 17 is commonly used for management of industrial wastewater, but the measurement method we offer applies the alkali method ( $\text{COD}_{\text{OH}}$ ) according to JIS K 0102 19 and allows simple measurement in a short period of time.

In the JIS alkali method, the amount of potassium permanganate that has been consumed in a boiled water bath for 20 minutes is obtained through titration. On the other hand, the measurement method we offer obtains the amount of potassium permanganate that has been consumed at a room temperature for 10 minutes by converting the decrease of absorbance into a COD value.

Verification is conducted by using glucose reference solution, but the degree of oxidation of oxidized substance in the sample by potassium permanganate differs depending on the type and the amount of the substance.

In addition, as the reaction conditions and measurement conditions differ even between the alkali method and the acid method, the values obtained by this measurement method are only approximate values and therefore due attention needs to be paid when this method is used for measurement of industrial wastewater.

As the value obtained by this method and that obtained by JIS method may not coincide with each other, use this method after obtaining the relationship between those methods.

### Information on reagent

Refer to the enclosed paper to the reagent.

The pH of the solution is 12 or higher and that of the neutralizer is 2 or lower.

The pH of the final wastewater as of after adding neutralizer is around 7. Be sure to dispose of wastewater after checking its pH.



## Color

Measurement of degree of yellow color of sample  
Calibration : Pt-Co color standard solution  
Range : 50 to 1000 degrees  
Reaction time : 0 minute

Cell : PACKTEST Square Cup  
Wavelength : 460 nm

### Procedure

1. Press **[Color]**.
2. Press **[OK]** to switch to the photometry window.
3. Fill the Cell with pure water for 1.5 mL (up to line). (Fig.1)
4. Put the Cell in the cell box and press **[Zero]**. (Fig.2)
5. Take out the Cell, discard the pure water, fill the same Cell with 1.5 mL of sample. (Fig.3)
6. Set the Cell in the cell box again and press **[Start]**. (Fig.4)
7. The result will be automatically displayed.

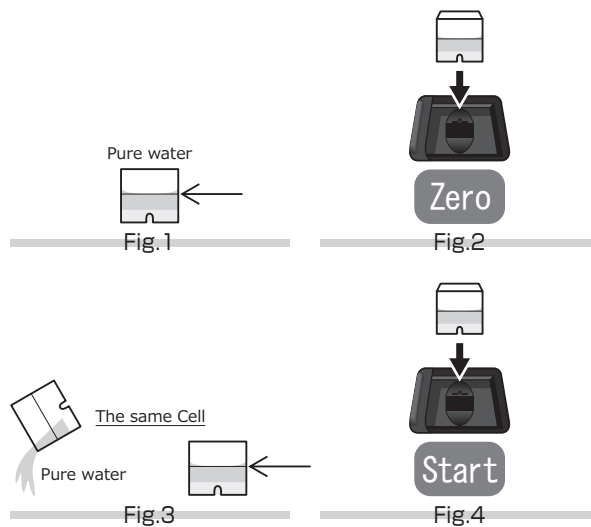

### CAUTION

1. This method is applied only to substances in pale yellow to brownish yellow colors existing in a dissolved state in water or in a colloidal state, and other color and turbid interfere the measurement.

## Cr<sup>6+</sup> Chromium (Hexavalent)

Color development: None → Light red → Red → Red purple  
Method : Diphenylcarbazide  
Range : 0.05 — 1.50 mg/L(ppm)  
Reagent : WAK-Cr<sup>6+</sup> Tube  
Reaction time : 2 min. after drawing sample into the tube.

Cell : PACKTEST Square Cup  
Wavelength : 542 nm, 580 nm, 670 nm

### Procedure

1. Press **[Cr<sup>6+</sup>]**.
2. Press **[OK]** to switch to the photometry window.
3. Fill the Cell with the sample for 1.5 mL (up to line). (Fig.1)
4. Put the Cell in the cell box and press **[Zero]**. (Fig.2)
5. Suck the whole amount of the sample in the Cell into the tube and press **[Start]** at the same time. (Fig.3)
6. Lightly shake the tube in Step 5 from 5 to 6 times, return the solution in the tube to the Cell in a gentle manner, set it again in the cell box. (Fig.4)
7. After 2 minutes have elapsed, the concentration will be automatically displayed.

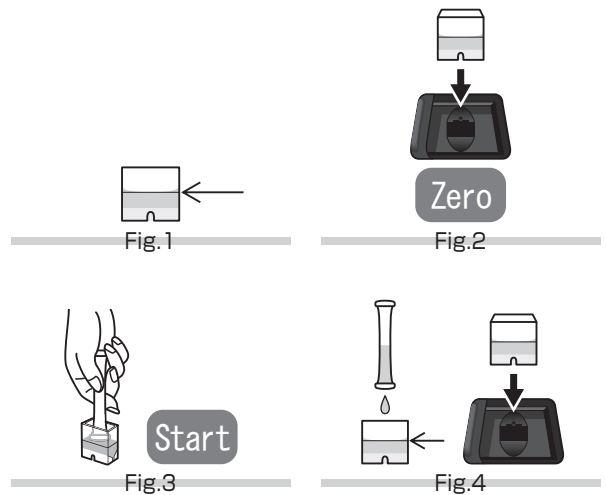

### CAUTION

1. In this method, the concentration of hexavalent chromium (Cr<sup>6+</sup>) in the sample is measured.  
To measure the concentration of the total chromium including trivalent chromium (Cr<sup>3+</sup>), refer to "Cr<sup>T</sup> Total Chromium".  
If a reductive substance coexists in the sample, hexavalent chromium is reduced to trivalent chromium. In this case, perform measurement of the total chromium.
2. The optimum pH during color development is 2 or less. Turn a sample of pH9 or greater to neutral or lower with dilute sulfuric acid or the like. In particular, if the sample is wastewater from fresh concrete plant or the like whose pH is high, pay special attention.
3. Perform measurement with the sample temperature set to 15 to 30°C.

### Influence of coexisting substance

The stored calibration curve has been created by using the standard solution. If the influence of other substance is considered, check the measurement value by comparing it with the official method or by standard addition method.  
The right chart is the list of interference data for acceptable level by adding each of the single substances to the standard solution.

Seawater does not affect the measurement.

If a reductive substance coexists in the sample, hexavalent chromium is reduced to trivalent chromium. In this case, perform measurement of the total chromium.

≤ 1000mg/L.: Ba <sup>2+</sup> , Ca <sup>2+</sup> , Cl <sup>-</sup> , CN <sup>-</sup> , Co <sup>2+</sup> , I <sup>-</sup> , K <sup>+</sup> , Mg <sup>2+</sup> , Mn <sup>2+</sup> , Na <sup>+</sup> , NH <sub>4</sub> <sup>+</sup> , Ni <sup>2+</sup> , NO <sub>3</sub> <sup>-</sup> , PO <sub>4</sub> <sup>3-</sup> , SO <sub>4</sub> <sup>2-</sup> , Zn <sup>2+</sup> , Phenol
≤ 500mg/L.: Al <sup>3+</sup> , F <sup>-</sup>
≤ 250mg/L.: B (III)
≤ 25mg/L.: NO <sub>2</sub> <sup>-</sup>
≤ 10mg/L.: Ag <sup>+</sup>
≤ 5mg/L.: Cu <sup>2+</sup> , Mo (VI)
≤ 2mg/L.: Fe <sup>3+</sup>
≤ 1mg/L.: Residual Chlorine
< 1mg/L.: V (V)

### Information on reagent

Refer to the usage that comes with PACKTEST.  
The pH of the solution is 2 or less.

## Cr<sup>6+</sup>-D Chromium (Hexavalent) (Low Range)

Color development: None → Light red → Red purple

Cell : PACKTEST Square Cup

Method : Diphenylcarbazide Absorptiometry Coupled with Collecting on Membrane Filter

Wavelength : 542 nm, 580 nm, 670 nm

Range : 0.003 — 0.100 mg/L(ppm)

Reagent : DPR—Cr<sup>6+</sup>D R-1 (Pack) , R-2 (Liquid) , R-3 (Liquid)

Reaction time : 0 min.

Usage : Read the instruction supplied with "DPR Reagent: Chromium(Hexavalent)(Low Range)".

### Procedure

1. Press **[Cr<sup>6+</sup>-D]**.
2. Press **[OK]** to switch to the photometry window.
3. Perform procedures ① - ⑥ of the usage supplied with the DPR Reagent: Chromium(Hexavalent) (Low Range) (model: DPR-Cr<sup>6+</sup>D).
4. Fill the Cell with pure water (or tap water) so that the water level exceeds the mark line (1.5 mL). (Fig.1)
5. Put the Cell in the cell box and press **[Zero]**. (Fig.2)
6. Take out the Cell and completely discard the water in the Cell. If water droplets exist on the inner wall, remove them by absorbing them with tissue paper or the like. (Fig.3)
7. Suck about 0.5 mL of air into the 2.5 mL syringe, suck the R-3 reagent in succession, and adjust the liquid level to the scale mark of 1.9 mL. (Fig.4)
8. Attach the filter to the 2.5 mL syringe, and extrude the R-3 reagent one drop by one drop to collect the whole amount in the Cell. When you have extruded almost half the R-3 reagent from the syringe, pull back the pushing rod to the uppermost portion (scale mark of 2.5 mL). Then, slowly extrude the remaining R-3 reagent one drop by one drop. The collection completes when the pushing rod reaches the lowermost part and the remaining R-3 reagent has been completely extruded. (Fig.5)
9. Attach the cap of the Cell, shake the Cell 5 to 6 times while strongly holding it, and then remove the cap.(If the cap is kept attached, the solution leaks out.)(Fig.6)
10. Set the Cell in the cell box again and press **[Start]**. (Fig.7)
11. The concentration will be automatically displayed.

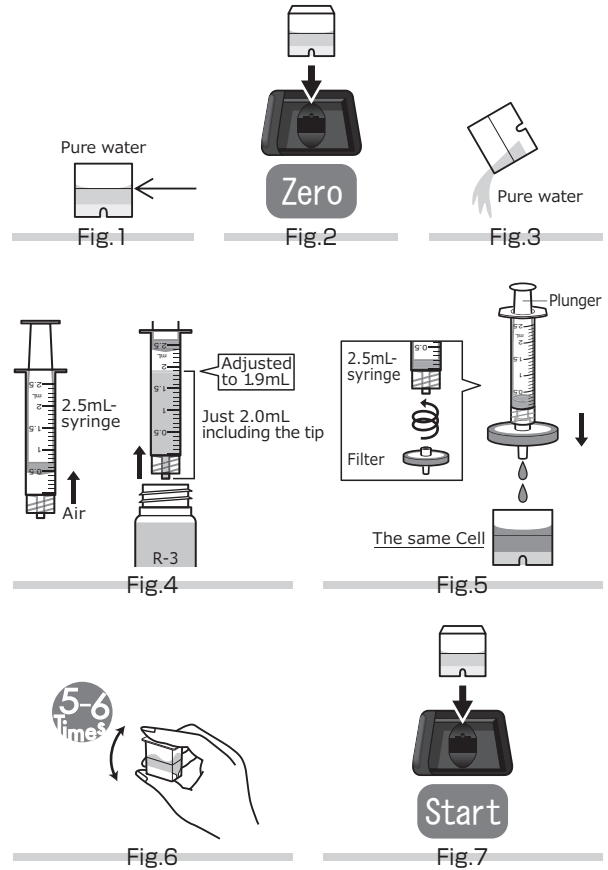

### CAUTION

1. In this method, the concentration of hexavalent chromium is obtained from the absorbance of the solution that has been obtained by using DPR Reagent: Chromium (Hexavalent) (Low Range). For notes on the operation, refer to the instruction supplied with the reagent.
2. The pH of the sample as of after adding R-1 reagent is 1, that of the sample as of after adding R-2 reagent is 2, and that of the solution is 3 to 4. If the pH of the sample is not within the range from 2 to 9, neutralize the sample with dilute sulfuric acid or dilute sodium hydroxide solution, etc.
3. As the sample as of after adding reagent is strongly acidic, wear PPE during measurement and gently proceed with the operation procedures. Note that if the connection of the screw part between each syringe and filter is loose, the solution could leak out.
4. Perform measurement with the sample temperature set to 15 to 30°C .

### Influence of coexisting substance

Refer to the instruction supplied with "DPR Reagent: Chromium(Hexavalent)(Low Range)".

### Information on reagent

Refer to the instruction supplied with "DPR Reagent: Chromium(Hexavalent)(Low Range)".

The pH of the solution is 3 to 4.

## Cr<sup>T</sup> Total Chromium

Color development: None → Light red → Red → Red purple

Method : Oxidation and Diphenylcarbazide

Range : 0.05 — 1.50 mg/L(ppm)

Reagent : Pretreatment Reagent for Total Chromium (Model: Cr-RA) R-1 (Dropper) , R-2 (Dropper) , R-3 (Dropper) , WAK-Cr<sup>6+</sup> Tube

Specified tool : Beaker, Heater

Reaction time : 2 min. after drawing sample into the tube.

Cell : PACKTEST Square Cup

Wavelength : 542 nm, 580 nm, 670 nm

### Pretreatment method

Conduct pretreatment by following the procedures below.

1. Fill the beaker with 15 mL of sample, and add 5 droplets of the R-1 reagent. (Fig.1)
2. While heating the sample up to a moderately boiling state, add the R-2 reagent until pale reddish violet color remains even when the sample is stirred. (Fig.2)
3. Stop heating the sample, and add one droplet of the R-3 reagent to decolor the pale reddish violet color. If the pale reddish violet color remains, further add one droplet of R-3 reagent. (Fig.3)  
If the amount of the sample has decreased, add pure water up to 15 mL.
4. Cool down the sample in the beaker up to 15 to 30°C, fill the Cell with 1.5 mL of the sample (up to line). (Fig.4)
5. Measure it by following the "Procedure"

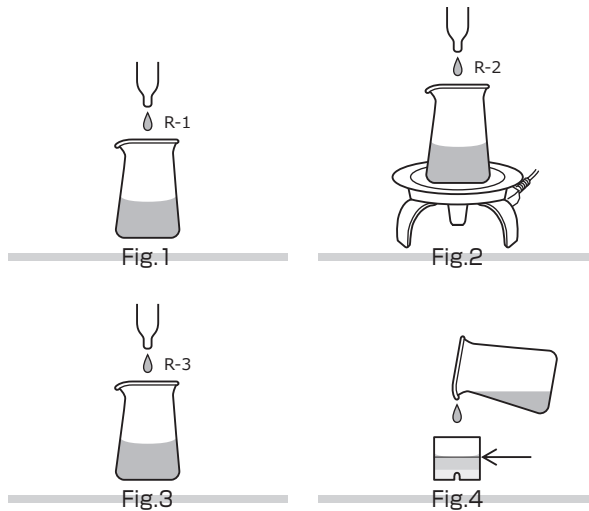

### Procedure

1. Press [Cr<sup>T</sup>].
2. Press [OK] to switch to the photometry window.
3. Put the Cell containing the sample that has gone through pretreatment in the cell box, and press [Zero]. (Fig.5)
4. Suck the whole amount of the sample in the Cell into the tube and press [Start] at the same time. (Fig.6)
5. Lightly shake the tube in Step 4 from 5 to 6 times, return the solution in the tube to the Cell in a gentle manner, set it again in the cell box. (Fig.7)
6. After 2 minutes have elapsed, the concentration will be automatically displayed.

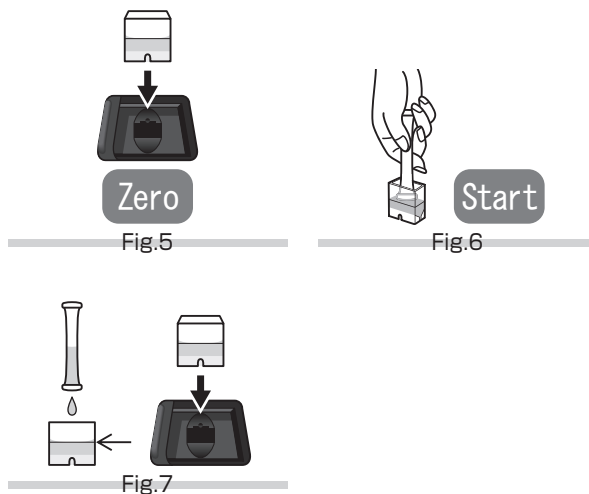

### CAUTION

In this method, the concentration of the total chromium including trivalent chromium (Cr<sup>3+</sup>) and hexavalent chromium (Cr<sup>6+</sup>) is measured.

### Influence of coexisting substance

The stored calibration curve has been created by using the standard solution.

If the influence of other substance is considered, check the measurement value by comparing it with the official method or by standard addition method.

For details, refer to "Cr<sup>6+</sup> Chromium (Hexavalent)".

### Information on reagent

Refer to the enclosed paper to the reagent.

The pH of the R-1 reagent and the solution is 2 or less.

## Cu Copper

Color development: None → Light orange → Orange  
Method : Bathocuproine  
Range : 0.10 — 5.00 mg/L(ppm)  
Reagent : WAK-Cu Tube  
Reaction time : 1 min. after drawing sample into the tube.

Cell : PACKTEST Square Cup  
Wavelength : 482 nm, 520 nm

### Procedure

1. Press **[Cu]**.
2. Press **[OK]** to switch to the photometry window.
3. Fill the Cell with the sample for 1.5 mL (up to line). (Fig.1)
4. Put the Cell in the cell box and press **[Zero]**. (Fig.2)
5. Suck the whole amount of the sample in the Cell into the tube and press **[Start]** at the same time. (Fig.3)
6. Lightly shake the tube in Step 5 from 5 to 6 times, return the solution in the tube to the Cell in a gentle manner, set it again in the cell box. (Fig.4)
7. After 1 minute has elapsed, the concentration will be automatically displayed.

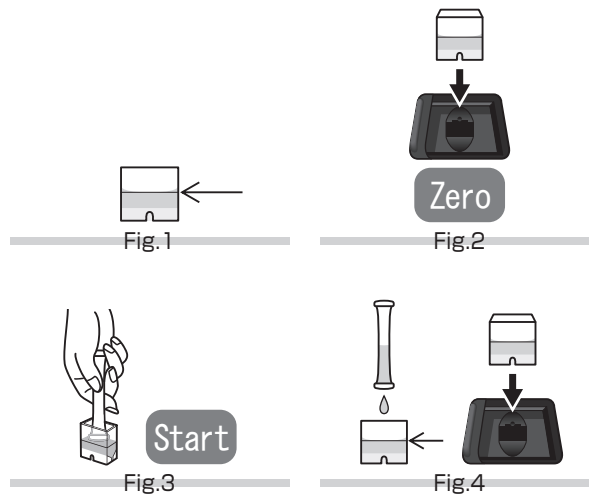

### CAUTION

1. In this method, the concentration of ionized univalent and divalent copper ( $\text{Cu}^+$ ,  $\text{Cu}^{2+}$ ) in the sample is measured. If a concentration measurement value including suspension, precipitate and complex is required, dissolve the target substance in advance and then perform measurement.
2. The optimum pH during color development is 6. If the pH of the sample is not within the range from 2 to 10, neutralize the sample with dilute sulfuric acid or dilute sodium hydroxide solution, etc.
3. Perform measurement with the sample temperature set to 15 to 30°C.

### Influence of coexisting substance

The stored calibration curve has been created by using the standard solution. If the influence of other substance is considered, check the measurement value by comparing it with the official method or by standard addition method.

The right chart is the list of interference data for acceptable level by adding each of the single substances to the standard solution.

Seawater does not affect the measurement.  
Oxidizing substance may affect the measurement.

≤ 1000mg/L.: B (III),  $\text{Ca}^{2+}$ ,  $\text{Cl}^-$ ,  $\text{F}^-$ ,  $\text{I}^-$ ,  $\text{K}^+$ ,  $\text{Mg}^{2+}$ , Mo (VI),  $\text{Na}^+$ ,  
 $\text{NH}_4^+$ ,  $\text{Ni}^{2+}$ ,  $\text{NO}_2^-$ ,  $\text{NO}_3^-$ ,  $\text{PO}_4^{3-}$ ,  $\text{SO}_3^{2-}$ ,  $\text{SO}_4^{2-}$ ,  
Residual Chlorine, Phenol  
≤ 250mg/L.:  $\text{Co}^{2+}$ ,  $\text{Mn}^{2+}$   
≤ 100mg/L.:  $\text{Ba}^{2+}$   
≤ 50mg/L.:  $\text{Zn}^{2+}$ , Anionic Surfactant  
≤ 20mg/L.:  $\text{Cr}^{3+}$ , Cr (VI)  
≤ 10mg/L.:  $\text{Ag}^+$   
≤ 5mg/L.:  $\text{Fe}^{2+}$ ,  $\text{Fe}^{3+}$   
≤ 2mg/L.:  $\text{Al}^{3+}$   
≤ 1mg/L.:  $\text{CN}^-$

### Information on reagent

Refer to the usage that comes with PACKTEST.  
The pH of the solution is about 6.

## Cu-M Copper (DDTC)

Color development: None → Yellow Brown  
Method : DDTC  
Range : 0.5 — 5.0 mg/L(ppm)  
Reagent : WAK-CuM Tube  
Reaction time : 3 min. after drawing sample into the tube.

Cell : PACKTEST Square Cup  
Wavelength : 451 nm, 550 nm

### Procedure

1. Press **[Cu-M]**.
2. Press **[OK]** to switch to the photometry window.
3. Fill the Cell with the sample for 1.5 mL (up to line). (Fig.1)
4. Put the Cell in the cell box and press **[Zero]**. (Fig.2)
5. Suck the whole amount of the sample in the Cell into the tube and press **[Start]** at the same time. (Fig.3)
6. Lightly shake the tube in Step 5 about 10 times. (Fig.4)
7. Gently return the solution in the tube to the Cell, set it again in the cell box. (Fig.5)
8. After 3 minutes have elapsed, the concentration will be automatically displayed.

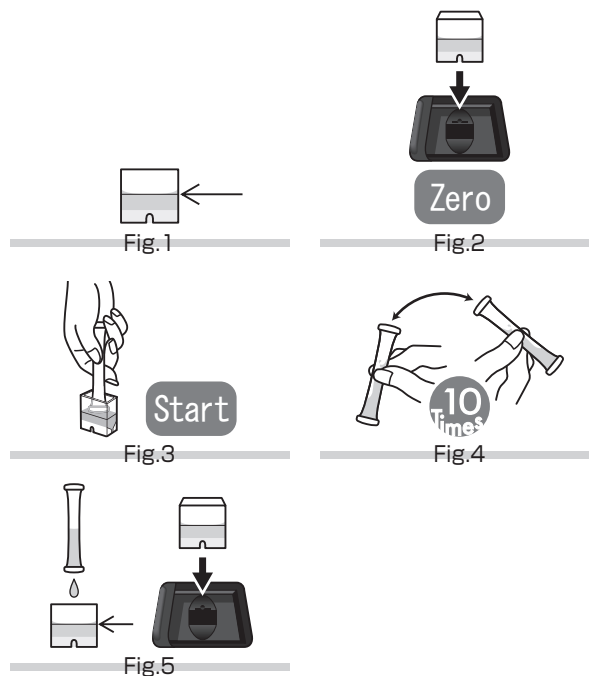

### CAUTION

1. In this method, the concentration of ionized copper ( $\text{Cu}^{2+}$ ) in the sample is measured.
2. The optimum pH during color development is 9. If the pH of the sample is not within the range from 5 to 9, neutralize the sample with dilute sulfuric acid or dilute sodium hydroxide solution, etc.
3. Perform measurement with the sample temperature set to 15 to 30°C.
4. If the concentration of copper in the sample is 10mg/L or less, the result is displayed as "OVER". However, note that if the concentration is 15mg/L or higher, precipitation of Cu-DDTC occurs and result may be obtained from a sample exceeding the measurement range.
5. Do not shake the tube strongly that may cause negative measurement error.

### Influence of coexisting substance

The stored calibration curve has been created by using the standard solution. If the influence of other substance is considered, check the measurement value by comparing it with the official method or by standard addition method.

The right chart is the list of interference data for acceptable level by adding each of the single substances to the standard solution.

≤ 1000mg/L.:  $\text{Al}^{3+}$ , B (III),  $\text{Ba}^{2+}$ ,  $\text{Ca}^{2+}$ ,  $\text{Cl}^-$ ,  $\text{F}^-$ ,  $\text{I}^-$ ,  $\text{K}^+$ ,  $\text{Mg}^{2+}$ ,  $\text{Mn}^{2+}$ ,  
Mo (VI),  $\text{Na}^+$ ,  $\text{NH}_4^+$ ,  $\text{NO}_2^-$ ,  $\text{NO}_3^-$ ,  $\text{PO}_4^{3-}$ ,  $\text{SO}_4^{2-}$ ,  $\text{Zn}^{2+}$ ,  
Anionic Surfactant, Silica  
≤ 500mg/L.: Phenol  
≤ 25mg/L.:  $\text{Fe}^{2+}$ ,  $\text{Fe}^{3+}$ , Residual Chlorine  
≤ 10mg/L.:  $\text{CN}^-$ , Cationic Surfactant  
≤ 5mg/L.:  $\text{Co}^{2+}$ ,  $\text{Cr}^{3+}$ , Cr (VI),  $\text{Ni}^{2+}$

Seawater does not affect the measurement.

### Information on reagent

Refer to the usage that comes with PACKTEST.

The pH of the solution is about 9.

## DET Anionic Surfactants

Color development: None → Light blue → Blue

Method : Methylene Blue - Anion surfactant Complex

Range : 0.05 — 1.20 mg/L(ppm)

Reagent : Water Analysis Set: Anionic Surfactants (Model: WA-DET) R-1 ( Dropper ) , R-2 ( Liquid)

Reaction time : 0 min.

Usage : Read the instruction supplied with "Water Analysis Set: Anionic Surfactants".

Cell : PACKTEST Square Cup

Wavelength : 620 nm

### Pretreatment method

1. By following the procedure Step ④ in the usage supplied with the Water Analysis Set: Anionic Surfactants, add 1.5 mL of the R-2 reagent using the pipette. (The addition amount of the R-2 reagent differs from that in the case of visual colorimetry.)(Fig.1)

2. Fit the cap to the tube and intensely shake it so that the R-2 reagent spreads across the whole wall surface of the tube, and use the liquid as the solution. (Fig.2)

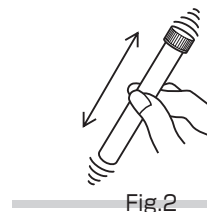
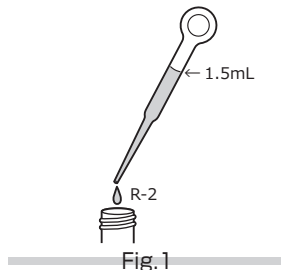

Fig.2

### Procedure

1. Press **[DET]**.  
2. Press **[OK]** to switch to the photometry window.  
3. Fill the Cell with pure water (or tap water) for 1.5 mL (up to line). (Fig.3)

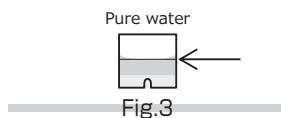

Fig.3

4. Put the Cell in the cell box and press **[Zero]**. (Fig.4)

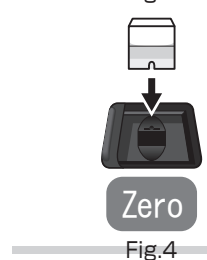

Fig.4

5. Take out the Cell, discard the pure water, and pour the whole amount of the prepared solution to the same Cell. (Fig.5)

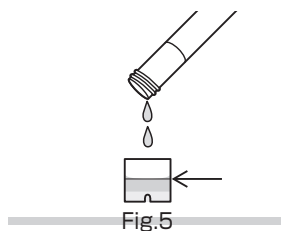

Fig.5

6. Set the Cell in the cell box again and press **[Start]**. (Fig.6)

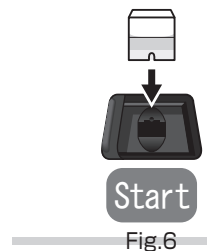

Fig.6

7. The concentration will be automatically displayed.

### CAUTION

1. Even existence of a small amount of cationic surfactants agent, nonionic surfactants and oil can cause a negative measurement error. If these substances are considered to coexist at high concentration, dilute the sample by 10 times in advance and then perform measurement, and multiply the obtained value by 10.

\*Dilution method: Fill the tube with 2 mL of the sample, and add pure water (or tap water) up to the mark line on the tube.

\*If river water containing a non-ionic surfactants at a concentration of 1 mg/L or higher as of before adding reagent is intensely shaken, tiny bubbles will be formed on the water surface.

2. In river water, whose concentration of DET is 0.5 mg/L or higher, coexistent substances such as non-ionic surfactants are highly likely to exist, and the actual concentration of anionic surfactants may be much higher than the result.

3. The optimum pH during color development is 7. If the pH of the sample is not within the range from 3 to 9, neutralize the sample with dilute sulfuric acid or dilute sodium hydroxide solution, etc.

4. \*Perform measurement with the sample temperature set to 20°C .

If the sample temperature is other than 20 °C , multiplying the measurement value by either of the following coefficients can implement correction.

10°C ···· ×0.75                      15°C ···· ×0.85

25°C ···· ×1.25                      30°C ···· ×1.85

5. Use of a measuring pipette or the like instead of the supplied pipette enables more accurate measurement.

### Influence of coexisting substance

The stored calibration curve has been created by using the standard solution. If the influence of other substance is considered, check the measurement value by comparing it with the official method or by standard addition method.

The right chart is the list of interference data for acceptable level by adding each of the single substances to the standard solution.

It is not possible to measure seawater.

≤ 100mg/L.: Ca<sup>2+</sup>, Cl<sup>-</sup>, Cu<sup>2+</sup>, F<sup>-</sup>, K<sup>+</sup>, Mg<sup>2+</sup>, Na<sup>+</sup>, NH<sub>4</sub><sup>+</sup>, NO<sub>2</sub><sup>-</sup>,  
NO<sub>3</sub><sup>-</sup>, PO<sub>4</sub><sup>3-</sup>, SO<sub>4</sub><sup>2-</sup>, Residual Chlorine  
≤ 10mg/L.: Fe<sup>2+</sup>, Fe<sup>3+</sup>

### Information on reagent

Refer to the instruction supplied with "Water Analysis Set: Anionic Surfactants".

The pH of the solution is about 7.

## F Fluoride (Free)

Color development: Red → Purple  
Method : Lanthanum-Alizarin Complexon  
Range : 0.40 — 1.50 mg/L(ppm)  
Reagent : WAK-F Tube  
Reaction time : 15 min. after drawing sample into the tube.

Cell : PACKTEST Square Cup  
Wavelength : 616 nm, 521 nm

### Procedure

1. Press **[F]**.
2. Press **[OK]** to switch to the photometry window.
3. Fill the Cell with the sample for 1.5 mL (up to line). (Fig.1)
4. Put the Cell in the cell box and press **[Zero]**. (Fig.2)
5. Suck the whole amount of the sample in the Cell into the tube and press **[Start]** at the same time. (Fig.3)
6. Shake the tube in Step 5 about 10 times. (Fig.4)
7. Gently return the solution in the tube to the Cell, set it again in the cell box.
8. After 15 minutes have elapsed, the concentration will be automatically displayed.

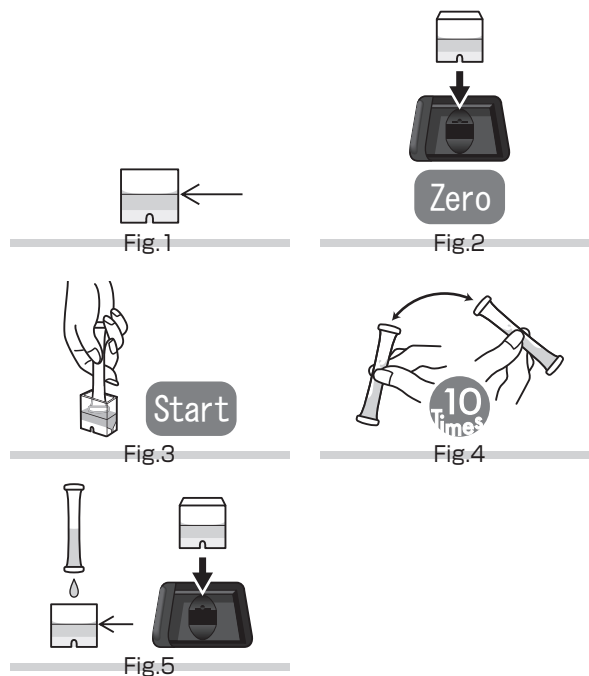

### CAUTION

1. In this method, a sample containing small amount of coexistent substance such as distillation-separated extract and natural water is handled and the concentration of ionized fluorine ( $F^-$ ) is measured. It is impossible to measure the concentration of fluoroborate ( $BF_4^-$ ). Implement the distillation procedures in the pretreatment before total fluorine measurement according to JIS K 0102 34.1.
2. The optimum pH during color development is 5. If the pH of the sample is not within the range from 3 to 9, neutralize the sample with dilute sulfuric acid or dilute sodium hydroxide solution, etc.
3. Perform measurement with the sample temperature set to 15 to 30°C.
4. When the concentration of fluorine ions is 100 mg/L or higher, the measurement value will be low. If high concentration is anticipated, dilute in advance and then perform measurement.

### Influence of coexisting substance

The stored calibration curve has been created by using the standard solution. If the influence of other substance is considered, check the measurement value by comparing it with the official method or by standard addition method.

The right chart is the list of interference data for acceptable level by adding each of the single substances to the standard solution.

It is not possible to measure seawater.

Fluorine combines with metallic element such as aluminum and iron to form a fluorocomplex, and combines with alkaline earth metal such as calcium to exist in the form of suspended solid or precipitate of fluoride, which may not be measured by this method.

#### Except for Heavy metal ions:

- ≤ 100mg/L.: B (III),  $Cl^-$ ,  $I^-$ ,  $K^+$ ,  $Mg^{2+}$ ,  $Na^+$ ,  $NH_4^+$ ,  $NO_2^-$ ,  $NO_3^-$ ,  $PO_4^{3-}$ ,  $SO_4^{2-}$ , Anionic Surfactant, Phenol
- ≤ 50mg/L.: Residual Chlorine
- ≤ 10mg/L.:  $Ca^{2+}$

#### Heavy metal ions:

- ≤ 10mg/L.:  $Ba^{2+}$ ,  $CN^-$ ,  $Cr^{3+}$ , Cr (VI),  $Mn^{2+}$
- ≤ 1mg/L.:  $Fe^{2+}$ ,  $Fe^{3+}$ , Mo (VI)
- < 1mg/L.:  $Al^{3+}$ ,  $Co^{2+}$ ,  $Cu^{2+}$ ,  $Ni^{2+}$ ,  $Zn^{2+}$

### Information on reagent

Refer to the usage that comes with PACKTEST.

The pH of the solution is about 5.



## Fe Iron

Color development: None → Light orange → Orange  
Method : Reduction and *o*-Phenanthroline  
Range : 0.10 — 5.00 mg/L(ppm)  
Reagent : WAK-Fe Tube  
Reaction time : 3 min. after drawing sample into the tube.

Cell : PACKTEST Square Cup  
Wavelength : 510 nm, 540 nm

### Procedure

1. Press **[Fe]**.
2. Press **[OK]** to switch to the photometry window.
3. Fill the Cell with the sample for 1.5 mL (up to line). (Fig.1)
4. Put the Cell in the cell box and press **[Zero]**. (Fig.2)
5. Suck the whole amount of the sample in the Cell into the tube and press **[Start]** at the same time. (Fig.3)
6. Lightly shake the tube in Step 5 from 5 to 6 times, return the solution in the tube to the Cell in a gentle manner, set it again in the cell box. (Fig.4)
7. After 3 minutes have elapsed, the concentration will be automatically displayed.

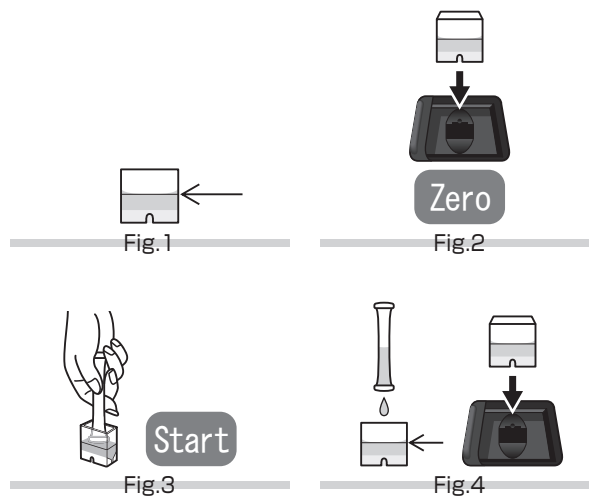

### CAUTION

1. In this method, the concentration of ionized iron ( $\text{Fe}^{2+}$ ,  $\text{Fe}^{3+}$ : dissolved iron) in the sample is measured. The dissolved state of iron greatly varies depending on the pH of the sample, and iron could exist in the form of suspended solid or precipitate. Perform measurement after pretreatment according to the measurement purpose.
2. The optimum pH during color development is 6. If this pH cannot be achieved, neutralize the sample as necessary. A sample with a small buffering capacity can be measured even if its pH is around 2.
3. To measure the concentration of the total iron in tap water or the like, you add 0.13 mL of 10% dilute sulfuric acid or two droplets of Dilute Sulfuric Acid (model: WAS-D-SO<sub>4</sub>) to 20 mL of sample, heat the sample until it almost boils, and suck the sample into the tube after cooling it down. It is possible to measure it without neutralization.
4. The concentration of such EDTA iron as used in hydroponics can also be measured without the pretreatment.
5. Perform measurement with the sample temperature set to 15 to 30°C.

### Influence of coexisting substance

The stored calibration curve has been created by using the standard solution. If the influence of other substance is considered, check the measurement value by comparing it with the official method or by standard addition method. The right chart is the list of interference data for acceptable level by adding each of the single substances to the standard solution.

Seawater does not affect the measurement.  
Oxidizing substance may affect the measurement.

#### Except for Heavy metal ions:

≤ 10mg/L.: B (III), Ca<sup>2+</sup>, Cl<sup>-</sup>, F<sup>-</sup>, I<sup>-</sup>, K<sup>+</sup>, Mg<sup>2+</sup>, Na<sup>+</sup>, NH<sub>4</sub><sup>+</sup>, NO<sub>2</sub><sup>-</sup>, NO<sub>3</sub><sup>-</sup>, PO<sub>4</sub><sup>3-</sup>, SO<sub>4</sub><sup>2-</sup>, Phenol

≤ 10mg/L.: Anionic Surfactant, Residual Chlorine

#### Heavy metal ions:

≤ 10mg/L.: Ba<sup>2+</sup>, Co<sup>2+</sup>, Cr<sup>3+</sup>, Cr (VI), Cu<sup>2+</sup>, Mn<sup>2+</sup>, Mo (VI), Ni<sup>2+</sup>, Zn<sup>2+</sup>  
≤ 1mg/L.: Al<sup>3+</sup>, CN<sup>-</sup>

### Information on reagent

Refer to the usage that comes with PACKTEST.  
The pH of the solution is about 6.

## Fe-D Iron (Low Range)

Color development: None → Light red → Red  
Method : Reduction and Bathophenatholine  
Range : 0.05 — 2.00 mg/L(ppm)  
Reagent : WAK-Fe (D) Tube  
Reaction time : 3 min. after drawing sample into the tube.

Cell : PACKTEST Square Cup  
Wavelength : 535 nm, 460 nm

### Procedure

1. Press **[Fe-D]**.
2. Press **[OK]** to switch to the photometry window.
3. Fill the Cell with the sample for 1.5 mL (up to line). (Fig.1)
4. Put the Cell in the cell box and press **[Zero]**. (Fig.2)
5. Suck the whole amount of the sample in the Cell into the tube and press **[Start]** at the same time. (Fig.3)
6. Lightly shake the tube in Step 5 from 5 to 6 times, return the solution in the tube to the Cell in a gentle manner, set it again in the cell box. (Fig.4)
7. After 3 minutes have elapsed, the concentration will be automatically displayed.

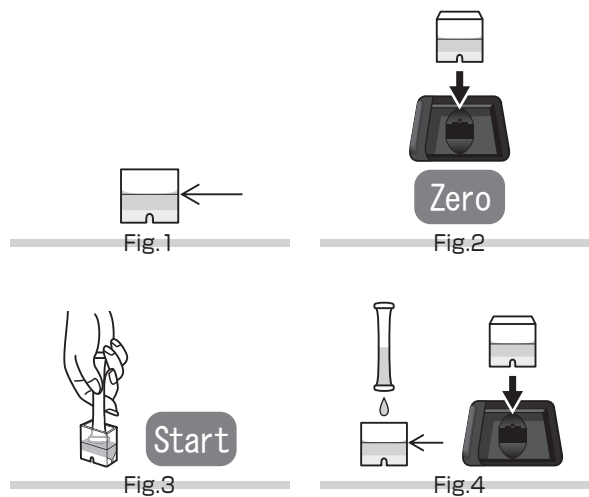

### CAUTION

1. In this method, the concentration of ionized iron ( $\text{Fe}^{2+}$ ,  $\text{Fe}^{3+}$ : dissolved iron) in the sample is measured. The dissolved state of iron greatly varies depending on the pH of the sample, and iron could exist in the form of suspended solid or precipitate. Perform measurement after pretreatment according to the measurement purpose.
2. The optimum pH during color development is 7. If this pH cannot be achieved, neutralize the sample as necessary. A sample with a small buffering capacity can be measured even if its pH is around 2.
3. To measure the concentration of the total iron in tap water or the like, you add 0.13 mL of 10% dilute sulfuric acid or two droplets of Dilute Sulfuric Acid (model: WAS-D-SO<sub>4</sub>) to 20 mL of sample, heat the sample until it almost boils, and suck the sample into the tube after cooling it down. It is possible to measure it without neutralization.
4. The concentration of such EDTA iron as used in hydroponics can also be measured without the pretreatment.
5. Perform measurement with the sample temperature set to 15 to 30°C.

### Influence of coexisting substance

The stored calibration curve has been created by using the standard solution. If the influence of other substance is considered, check the measurement value by comparing it with the official method or by standard addition method. The right chart is the list of interference data for acceptable level by adding each of the single substances to the standard solution.

It is not possible to measure seawater.  
Oxidizing substance may affect the measurement.

$\leq 500\text{mg/L}$ .; B (III), $\text{Ca}^{2+}$ , $\text{Cl}^-$ , $\text{F}^-$ , $\text{I}^-$ , $\text{K}^+$ , $\text{Mg}^{2+}$ , $\text{Mn}^{2+}$ , $\text{Na}^+$ , $\text{NH}_4^+$ , $\text{NO}_3^-$ , $\text{SO}_4^{2-}$
$\leq 500\text{mg/L}$ .; Phenol
$\leq 50\text{mg/L}$ .; Cr (VI), Mo (VI), $\text{Ni}^{2+}$ , $\text{NO}_2^-$
$\leq 10\text{mg/L}$ .; $\text{Zn}^{2+}$
$\leq 5\text{mg/L}$ .; $\text{PO}_4^{3-}$
$\leq 2\text{mg/L}$ .; $\text{Cr}^{3+}$ , Residual Chlorine
$\leq 1\text{mg/L}$ .; $\text{Ba}^+$ , $\text{CN}^-$
$< 1\text{mg/L}$ .; $\text{Al}^{3+}$ , $\text{Co}^{2+}$ , $\text{Cu}^{2+}$

### Information on reagent

Refer to the usage that comes with PACKTEST.  
The pH of the solution is about 7.

## Fe<sup>2+</sup> Iron (Divalent)

Color development: None → Light orange → Orange  
Method : *o*-Phenanthroline  
Range : 0.10 — 5.00 mg/L(ppm)  
Reagent : WAK-Fe<sup>2+</sup> Tube  
Reaction time : 3 min. after drawing sample into the tube.

Cell : PACKTEST Square Cup  
Wavelength : 510 nm, 540 nm

### Procedure

1. Press **[Fe<sup>2+</sup>]**.
2. Press **[OK]** to switch to the photometry window.
3. Fill the Cell with the sample for 1.5 mL (up to line). (Fig.1)
4. Put the Cell in the cell box and press **[Zero]**. (Fig.2)
5. Suck the whole amount of the sample in the Cell into the tube and press **[Start]** at the same time. (Fig.3)
6. Lightly shake the tube in Step 5 from 5 to 6 times, return the solution in the tube to the Cell in a gentle manner, set it again in the cell box. (Fig.4)
7. After 3 minutes have elapsed, the concentration will be automatically displayed.

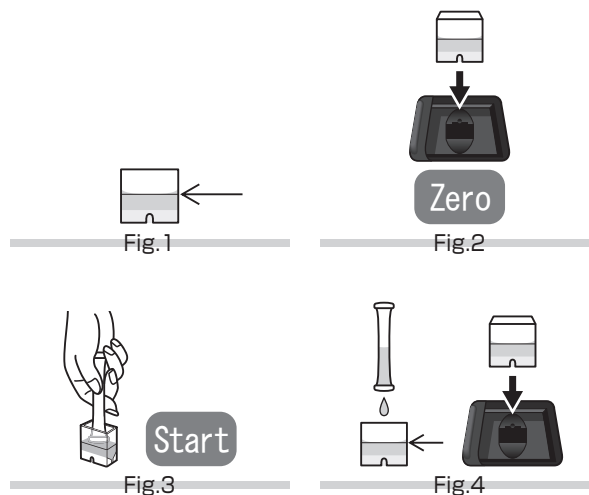

### CAUTION

1. In this method, the concentration of ionized divalent iron (Fe<sup>2+</sup>) in the sample is measured.
2. The dissolved state of iron greatly varies depending on the pH of the sample, and iron could exist in the form of suspended solid or precipitate.  
To measure the concentration of total iron in tap water or the like, refer to "Fe Iron" or "Fe-D Iron (Low Range)".
3. The optimum pH during color development is 5. If the pH of the sample is not within the range from 2 to 9, neutralize the sample with dilute sulfuric acid or dilute sodium hydroxide solution, etc.
4. Perform measurement with the sample temperature set to 15 to 30°C.

### Influence of coexisting substance

The stored calibration curve has been created by using the standard solution. If the influence of other substance is considered, check the measurement value by comparing it with the official method or by standard addition method. The right chart is the list of interference data for acceptable level by adding each of the single substances to the standard solution.

Seawater does not affect the measurement.  
Oxidizing substance (residual chlorine, Cr<sup>6+</sup> etc.) turns Fe<sup>2+</sup> into Fe<sup>3+</sup>.

#### Except for Heavy metal ions:

- ≤ 100mg/L.: B (III), Ca<sup>2+</sup>, Cl<sup>-</sup>, F<sup>-</sup>, I<sup>-</sup>, K<sup>+</sup>, Mg<sup>2+</sup>, Na<sup>+</sup>, NH<sub>4</sub><sup>+</sup>, NO<sub>2</sub><sup>-</sup>, NO<sub>3</sub><sup>-</sup>, PO<sub>4</sub><sup>3-</sup>, SO<sub>4</sub><sup>2-</sup>, Phenol
- ≤ 10mg/L.: Anionic Surfactant
- < 1mg/L.: Residual Chlorine

#### Heavy metal ions:

- ≤ 10mg/L.: Al<sup>3+</sup>, Ba<sup>2+</sup>, Cr<sup>3+</sup>, Fe<sup>3+</sup>, Mn<sup>2+</sup>, Mo (VI), Ni<sup>2+</sup>, Zn<sup>2+</sup>
- ≤ 1mg/L.: CN<sup>-</sup>, Co<sup>2+</sup>, Cu<sup>2+</sup>
- < 1mg/L.: Cr (VI)

### Information on reagent

Refer to the usage that comes with PACKTEST.  
The pH of the solution is about 5.

## Fe<sup>2+</sup>-D Iron (Divalent) (Low Range)

Color development: None → Light red → Red  
Method : Bathophenatholine  
Range : 0.05 — 2.00 mg/L(ppm)  
Reagent : WAK-Fe<sup>2+</sup> (D) Tube  
Reaction time : 3 min. after drawing sample into the tube.

Cell : PACKTEST Square Cup  
Wavelength : 535 nm, 460 nm

### Procedure

1. Press **[Fe<sup>2+</sup>-D]**.
2. Press **[OK]** to switch to the photometry window.
3. Fill the Cell with the sample for 1.5 mL (up to line). (Fig.1)
4. Put the Cell in the cell box and press **[Zero]**. (Fig.2)
5. Suck the whole amount of the sample in the Cell into the tube and press **[Start]** at the same time. (Fig.3)
6. Lightly shake the tube in Step 5 from 5 to 6 times, return the solution in the tube to the Cell in a gentle manner, set it again in the cell box. (Fig.4)
7. After 3 minutes have elapsed, the concentration will be automatically displayed.

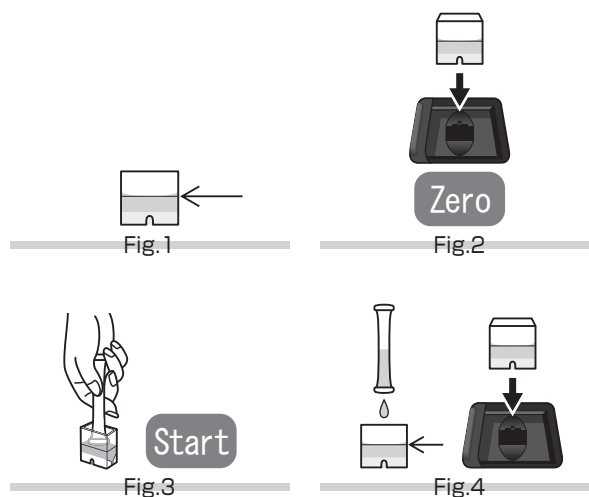

### CAUTION

1. In this method, the concentration of ionized divalent iron (Fe<sup>2+</sup>) in the sample is measured.
2. The dissolved state of iron greatly varies depending on the pH of the sample, and iron could exist in the form of suspended solid or precipitate.  
To measure the concentration of total iron in tap water or the like, refer to "Fe Iron" or "Fe-D Iron (Low Range)".
3. The optimum pH during color development is 5. If the pH of the sample is not within the range from 2 to 9, neutralize the sample with dilute sulfuric acid or dilute sodium hydroxide solution, etc.
4. Perform measurement with the sample temperature set to 15 to 30°C.

### Influence of coexisting substance

The stored calibration curve has been created by using the standard solution. If the influence of other substance is considered, check the measurement value by comparing it with the official method or by standard addition method.  
The right chart is the list of interference data for acceptable level by adding each of the single substances to the standard solution.

It is not possible to measure seawater.

Oxidizing substance (residual chlorine, Cr<sup>6+</sup> etc.) turns Fe<sup>2+</sup> into Fe<sup>3+</sup>.

#### Except for Heavy metal ions:

- ≤ 1000mg/L.: B (III), Cl<sup>-</sup>, F<sup>-</sup>, I<sup>-</sup>, K<sup>+</sup>, Mg<sup>2+</sup>, Na<sup>+</sup>, NH<sub>4</sub><sup>+</sup>, NO<sub>2</sub><sup>-</sup>, NO<sub>3</sub><sup>-</sup>, PO<sub>4</sub><sup>3-</sup>, SO<sub>4</sub><sup>2-</sup>, Phenol
- ≤ 500mg/L.: Ca<sup>2+</sup>
- ≤ 50mg/L.: Anionic Surfactant
- < 1mg/L.: Residual Chlorine

#### Heavy metal ions:

- ≤ 10mg/L.: Al<sup>3+</sup>, Ba<sup>2+</sup>, Cr<sup>3+</sup>, Fe<sup>3+</sup>, Mn<sup>2+</sup>, Mo (VI), Ni<sup>2+</sup>
- ≤ 5mg/L.: Zn<sup>2+</sup>
- ≤ 1mg/L.: Co<sup>2+</sup>, Cu<sup>2+</sup>
- < 1mg/L.: CN<sup>-</sup>, Cr (VI)

### Information on reagent

Refer to the usage that comes with PACKTEST.  
The pH of the solution is about 5.

## Fe<sup>3+</sup> Iron (Trivalent)

Color development: None → Light red → Reddish brown  
Method : Sulfosalicylic acid  
Range : 1.0 — 50.0 mg/L(ppm)  
Reagent : WAK-Fe<sup>3+</sup> Tube  
Reaction time : 1 min. after drawing sample into the tube.

Cell : PACKTEST Square Cup  
Wavelength : 505 nm, 620 nm

### Procedure

1. Press **[Fe<sup>3+</sup>]**.
2. Press **[OK]** to switch to the photometry window.
3. Fill the Cell with the sample for 1.5 mL (up to line). (Fig.1)
4. Put the Cell in the cell box and press **[Zero]**. (Fig.2)
5. Suck the whole amount of the sample in the Cell into the tube and press **[Start]** at the same time. (Fig.3)
6. Lightly shake the tube in Step 5 from 5 to 6 times, return the solution in the tube to the Cell in a gentle manner, set it again in the cell box. (Fig.4)
7. After 1 minute have elapsed, the concentration will be automatically displayed.

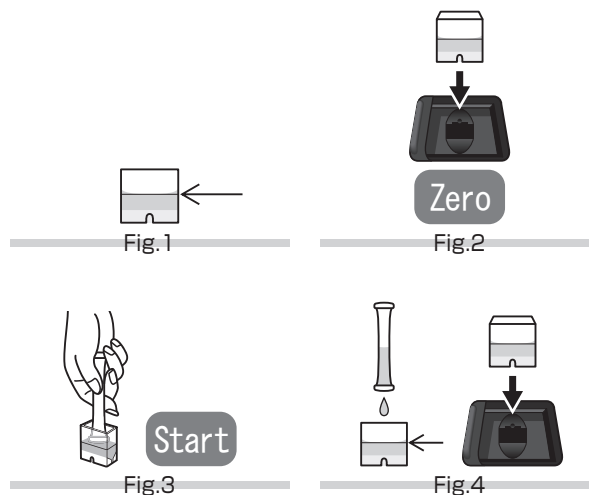

### CAUTION

1. In this method, the concentration of ionized trivalent iron (Fe<sup>3+</sup>) in the sample is measured.
2. The dissolved state of iron greatly varies depending on the pH of the sample, and iron could exist in the form of suspended solid or precipitate.  
To measure the concentration of total iron in tap water or the like, refer to "Fe Iron" or "Fe-D Iron (Low Range)".
3. The optimum pH during color development is 1. If the pH of the sample is not within the range from 1 to 9, neutralize the sample with dilute sulfuric acid or dilute sodium hydroxide solution, etc.
4. Perform measurement with the sample temperature set to 15 to 30°C.

### Influence of coexisting substance

The stored calibration curve has been created by using the standard solution. If the influence of other substance is considered, check the measurement value by comparing it with the official method or by standard addition method.  
The right chart is the list of interference data for acceptable level by adding each of the single substances to the standard solution.

It is not possible to measure seawater.

A reductive substance (ascorbic acid, etc.) turns Fe<sup>3+</sup> into Fe<sup>2+</sup>.

≤ 1000mg/L.: Ag <sup>+</sup> , Al <sup>3+</sup> , B (III), Ba <sup>2+</sup> , Ca <sup>2+</sup> , Cl <sup>-</sup> , Co <sup>2+</sup> , Cr <sup>3+</sup> , Fe <sup>2+</sup> , K <sup>+</sup> , Mg <sup>2+</sup> , Mn <sup>2+</sup> , Mo (VI), Na <sup>+</sup> , NH <sub>4</sub> <sup>+</sup> , Ni <sup>2+</sup> , NO <sub>3</sub> <sup>-</sup> , PO <sub>4</sub> <sup>3-</sup> , SO <sub>4</sub> <sup>2-</sup> , Zn <sup>2+</sup> , Residual Chlorine, Silica, Phenol
≤ 500mg/L.: Cr (VI), Cu <sup>2+</sup> , I <sup>-</sup> , Anionic Surfactant
≤ 200mg/L.: NO <sub>2</sub> <sup>-</sup> , V (V)
≤ 50mg/L.: F <sup>-</sup>
≤ 10mg/L.: Cationic Surfactant
≤ 1mg/L.: CN <sup>-</sup>

### Information on reagent

Refer to the usage that comes with PACKTEST.  
The pH of the solution is about 1.

## FOR Formaldehyde

Color development: Yellow → Yellow green → Green  
Method : MBTH  
Range : 0.20 — 1.00 mg/L(ppm)  
Reagent : WAK-FOR K-1 (Small Pack) , Tube  
Reaction time : 2 min. after drawing sample into the tube.

Cell : PACKTEST Square Cup  
Wavelength : 660 nm

### Procedure

1. Press **[FOR]**.
2. Press **[OK]** to switch to the photometry window.
3. Fill the Cell with the sample for 1.5 mL (up to line). (Fig.1)
4. Put the Cell in the cell box and press **[Zero]**. (Fig.2)
5. Add the K-1 reagent, attach the cap, shake the Cell 5 to 6 times to dissolve the reagent, and leave the Cell for 3 minutes. (Fig.3)
6. Suck the whole amount of the sample in the Cell into the tube and press **[Start]** at the same time. (Fig.4)
7. Lightly shake the tube in Step 6 about 10 times. (Fig.5)
8. Gently return the solution in the tube to the Cell, set it again in the cell box. (Fig.6)
9. After 2 minutes have elapsed, the concentration will be automatically displayed.

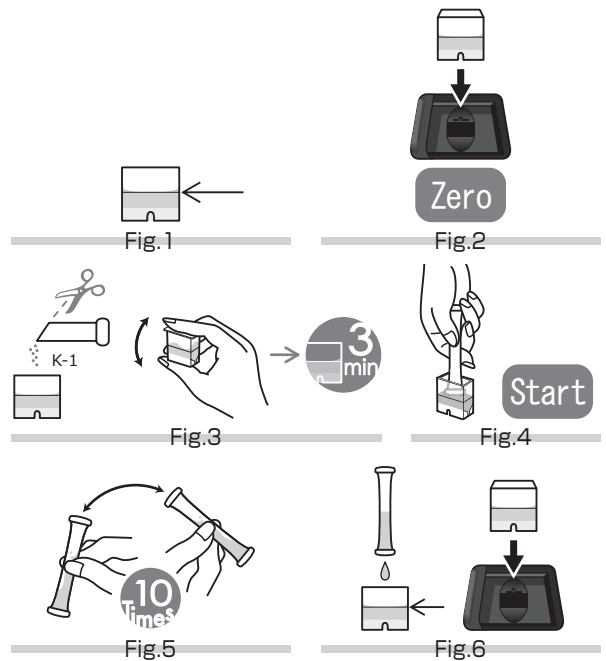

### CAUTION

1. The optimum pH during color development is 3. If the pH of the sample is not within the range from 5 to 8, neutralize the sample with dilute sulfuric acid or dilute sodium hydroxide solution, etc.
2. Perform measurement with the sample temperature set to 20°C.

If the sample temperature is other than 20 °C , multiplying the measurement value by either of the following coefficients can implement correction.

10°C ···· ×1.30      30°C ···· ×0.60

### Influence of coexisting substance

The stored calibration curve has been created by using the standard solution. If the influence of other substance is considered, check the measurement value by comparing it with the official method or by standard addition method. The right chart is the list of interference data for acceptable level by adding each of the single substances to the standard solution.

It is not possible to measure seawater.

Oxidizing substance or reductive substance may affect the measurement.

#### Except for Heavy metal ions:

- ≤ 100mg/L.: B (III) , Ca<sup>2+</sup> , Cl<sup>-</sup> , F<sup>-</sup> , K<sup>+</sup> , Mg<sup>2+</sup> , Na<sup>+</sup> , NH<sub>4</sub><sup>+</sup> , NO<sub>3</sub><sup>-</sup> , PO<sub>4</sub><sup>3-</sup>
- ≤ 50mg/L.: I<sup>-</sup> , SO<sub>4</sub><sup>2-</sup> , Phenol
- ≤ 20mg/L.: Anionic Surfactant , Residual Chlorine
- ≤ 1mg/L.: NO<sub>2</sub><sup>-</sup>

#### Heavy metal ions:

- ≤ 10mg/L.: Al<sup>3+</sup> , Ba<sup>2+</sup> , Co<sup>2+</sup> , Cu<sup>2+</sup> , Fe<sup>2+</sup> , Fe<sup>3+</sup> , Mn<sup>2+</sup> , Ni<sup>2+</sup> , Zn<sup>2+</sup>
- ≤ 5mg/L.: Cr (VI)
- ≤ 1mg/L.: CN<sup>-</sup>

### Information on reagent

Refer to the usage that comes with PACKTEST.

The pH of the solution is about 3.

## GLU Glucose

Color development: Light yellow → Light purple → Purple  
Method : 4-Aminoantipyrine with enzyme  
Range : 0.5 — 20.0 mg/L(ppm)  
Reagent : WAK-GLU Tube  
Reaction time : 12 min. after drawing sample into the tube.

Cell : PACKTEST Square Cup  
Wavelength : 539 nm, 610 nm

### Procedure

1. Press **[GLU]**.
2. Press **[OK]** to switch to the photometry window.
3. Fill the Cell with the sample for 1.5 mL (up to line). (Fig.1)
4. Put the Cell in the cell box and press **[Zero]**. (Fig.2)
5. Suck the whole amount of the sample in the Cell into the tube and press **[Start]** at the same time. (Fig.3)
6. Lightly shake the tube in Step 5 from 30 times. (Fig.4)
7. Return the solution in the tube to the Cell in a gentle manner, set it again in the cell box. (Fig.5)
8. After 12 minutes have elapsed, the concentration will be automatically displayed.

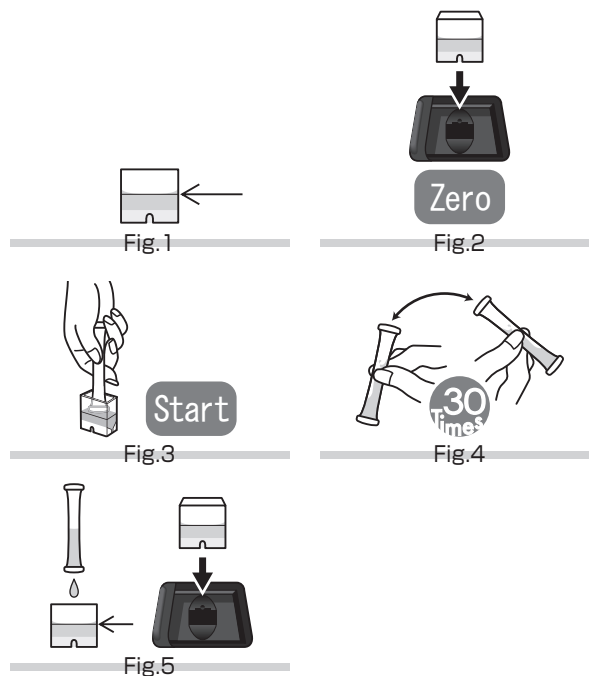

### CAUTION

1. The optimum pH during color development is 7. If the pH of the sample is not within the range from 6 to 9, neutralize the sample with dilute sulfuric acid or dilute sodium hydroxide solution, etc.
2. Perform measurement with the sample temperature set to 20 to 30°C .

### Influence of coexisting substance

The stored calibration curve has been created by using the standard solution. If the influence of other substance is considered, check the measurement value by comparing it with the official method or by standard addition method.

The right chart is the list of interference data for acceptable level by adding each of the single substances to the standard solution.

It is not possible to measure seawater.

Oxidizing substances such as residual chlorine and hydrogen peroxide cause a positive error.

Reductive substances sometimes cause a negative measurement error.

≤ 1000mg/L.:	B (III) , Cl <sup>-</sup> , F <sup>-</sup> , I <sup>-</sup> , K <sup>+</sup> , Mg <sup>2+</sup> , Na <sup>+</sup> , NH <sub>4</sub> <sup>+</sup> , NO <sub>3</sub> <sup>-</sup> , PO <sub>4</sub> <sup>3-</sup> , SO <sub>4</sub> <sup>2-</sup> , Citric acid, Succinic acid, Tartaric acid, Fructose, Sucrose, Lactose
≤ 500mg/L.:	Mo (VI) , NO <sub>2</sub> <sup>-</sup> , Zn <sup>2+</sup> , Silica
≤ 200mg/L.:	Mn <sup>2+</sup> , Ni <sup>2+</sup> , Starch
≤ 100mg/L.:	Ba <sup>2+</sup> , Co <sup>2+</sup> , Cr <sup>3+</sup> , Phenol
≤ 50mg/L.:	Ca <sup>2+</sup> , Cr (VI) , Anionic Surfactant
≤ 20mg/L.:	Al <sup>3+</sup> , CN <sup>-</sup> , Galactose
≤ 10mg/L.:	Ag <sup>+</sup> , Cu <sup>2+</sup> , Mannose, Cationic Surfactant
≤ 5mg/L.:	Fe <sup>3+</sup>
< 1mg/L.:	Fe <sup>2+</sup> , Residual Chlorine, Maltose

### Information on reagent

Refer to the usage that comes with PACKTEST.

The pH of the solution is about 7.

## H<sub>2</sub>O<sub>2</sub>-C Hydrogen Peroxide (High Range)

Color development: None → Yellow → Orange → Red brown  
Method : Potassium Iodide  
Range : 1 – 200 mg/L(ppm)  
Reagent : WAK-H<sub>2</sub>O<sub>2</sub> (C) Tube  
Reaction time : 1 min. after drawing sample into the tube.

Cell : PACKTEST Square Cup  
Wavelength : 470 nm, 550 nm

### Procedure

1. Press **[H<sub>2</sub>O<sub>2</sub>-C]**.
2. Press **[OK]** to switch to the photometry window.
3. Fill the Cell with the sample for 1.5 mL (up to line). (Fig.1)
4. Put the Cell in the cell box and press **[Zero]**. (Fig.2)
5. Suck the whole amount of the sample in the Cell into the tube and press **[Start]** at the same time. (Fig.3)
6. Lightly shake the tube in Step 5 from 5 to 6 times, return the solution in the tube to the Cell in a gentle manner, set it again in the cell box. (Fig.4)
7. After 1 minute has elapsed, the concentration will be automatically displayed.

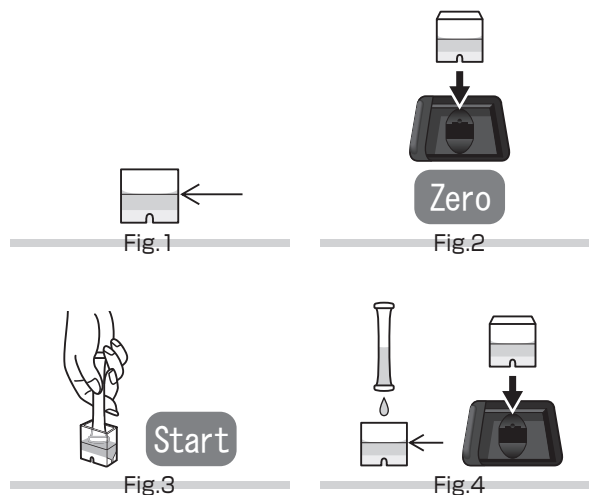

### CAUTION

1. The optimum pH during color development is 4. If the pH of the sample is not within the range from 2 to 9, neutralize the sample with dilute sulfuric acid or dilute sodium hydroxide solution, etc.
2. Perform measurement with the sample temperature set to 15 to 30°C .

### Influence of coexisting substance

The stored calibration curve has been created by using the standard solution. If the influence of other substance is considered, check the measurement value by comparing it with the official method or by standard addition method.

The right chart is the list of interference data for acceptable level by adding each of the single substances to the standard solution.

Seawater does not affect the measurement.

Reductive substances such as Fe<sup>2+</sup> and NO<sub>2</sub><sup>-</sup> consume hydrogen peroxide.

NO<sub>2</sub><sup>-</sup> may serve as an oxidizer and may cause a positive measurement error.

Oxidizing substances such as residual chlorine and ozone cause a positive measurement error.

≤ 1000mg/L.: Al<sup>3+</sup>, B (III), Ca<sup>2+</sup>, Cl<sup>-</sup>, F<sup>-</sup>, K<sup>+</sup>, Mg<sup>2+</sup>, Mn<sup>2+</sup>, Mo (VI),  
Na<sup>+</sup>, NH<sub>4</sub><sup>+</sup>, Ni<sup>2+</sup>, NO<sub>3</sub><sup>-</sup>, PO<sub>4</sub><sup>3-</sup>, SO<sub>4</sub><sup>2-</sup>, Phenol  
≤ 100mg/L.: Ba<sup>2+</sup>  
≤ 50mg/L.: Cr (VI), Zn<sup>2+</sup>, Anionic Surfactant  
≤ 5mg/L.: Cu<sup>2+</sup>, Fe<sup>3+</sup>

### Information on reagent

Refer to the usage that comes with PACKTEST.

The pH of the solution is about 4.



## H<sub>2</sub>O<sub>2</sub> Hydrogen Peroxide

Color development: None → Light purple → Purple  
Method : 4-Aminoantipyrine with enzyme  
Range : 0.10 — 2.50 mg/L(ppm)  
Reagent : WAK-H<sub>2</sub>O<sub>2</sub> Tube  
Reaction time : 2 min. after drawing sample into the tube.

Cell : PACKTEST Square Cup  
Wavelength : 539 nm, 590 nm

### Procedure

1. Press **[H<sub>2</sub>O<sub>2</sub>]**.
2. Press **[OK]** to switch to the photometry window.
3. Fill the Cell with the sample for 1.5 mL (up to line). (Fig.1)
4. Put the Cell in the cell box and press **[Zero]**. (Fig.2)
5. Suck the whole amount of the sample in the Cell into the tube and press **[Start]** at the same time. (Fig.3)
6. Lightly shake the tube in Step 5 from 5 to 6 times, return the solution in the tube to the Cell in a gentle manner, set it again in the cell box. (Fig.4)
7. After 2 minutes have elapsed, the concentration will be automatically displayed.

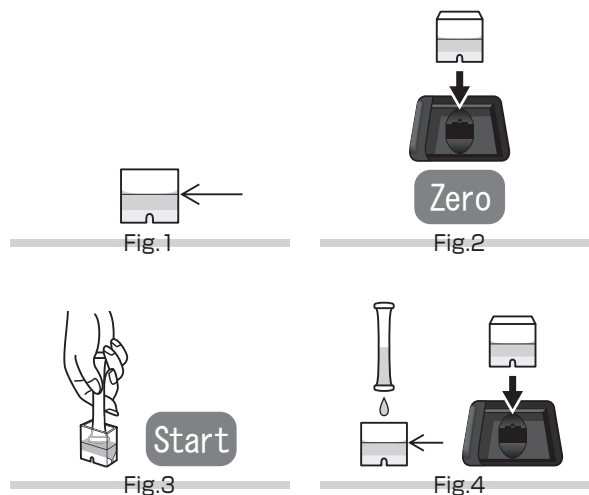

### CAUTION

1. The optimum pH during color development is 7. If the pH of the sample is not within the range from 6 to 9, neutralize the sample with dilute sulfuric acid or dilute sodium hydroxide solution, etc.
2. Perform measurement with the sample temperature set to 15 to 30°C .
3. If the concentration of hydrogen peroxide in the sample is 25 mg/L or less, the result is displayed as "OVER". However, note that if the concentration is 50 mg/L or higher, the color development becomes pale, and a result may be obtained from a sample exceeding the measurement range.

### Influence of coexisting substance

The stored calibration curve has been created by using the standard solution. If the influence of other substance is considered, check the measurement value by comparing it with the official method or by standard addition method.

The right chart is the list of interference data for acceptable level by adding each of the single substances to the standard solution.

Seawater does not affect the measurement.

Reductive substances such as Fe<sup>2+</sup> and NO<sub>2</sub><sup>-</sup> consume hydrogen peroxide.

Oxidizing substances such as residual chlorine and ozone cause a positive measurement error.

≤ 1000mg/L.: Ag <sup>+</sup> , B (III), Ba <sup>2+</sup> , Ca <sup>2+</sup> , Cl <sup>-</sup> , I <sup>-</sup> , K <sup>+</sup> , Mg <sup>2+</sup> , Na <sup>+</sup> , NH <sub>4</sub> <sup>+</sup> , Ni <sup>2+</sup> , NO <sub>3</sub> <sup>-</sup> , PO <sub>4</sub> <sup>3-</sup> , SO <sub>4</sub> <sup>2-</sup> , Zn <sup>2+</sup>
≤ 500mg/L.: F <sup>-</sup> , Fe <sup>3+</sup> , NO <sub>2</sub> <sup>-</sup>
≤ 250mg/L.: Phenol
≤ 50mg/L.: Cr <sup>3+</sup> , Cr (VI), Cu <sup>2+</sup> , Anionic Surfactant
≤ 20mg/L.: Al <sup>3+</sup> , Co <sup>2+</sup> , Mn <sup>2+</sup>
≤ 2mg/L.: Mo (VI)
≤ 1mg/L.: CN <sup>-</sup>
< 1mg/L.: Fe <sup>2+</sup> , Residual Chlorine

### Information on reagent

Refer to the usage that comes with PACKTEST.

The pH of the solution is about 7.

## HYD Hydrazine

Color development: None → Yellow  
Method : *p*-Dimethylaminobenzaldehyde  
Range : 0.03 – 1.00 mg/L(ppm)  
Reagent : WAK-HYD K-1(Dropper), Tube  
Reaction time : 20 min. after drawing sample into the tube.

Cell : PACKTEST Square Cup  
Wavelength : 455 nm, 480 nm

### Procedure

1. Press **[HYD]**.
2. Press **[OK]** to switch to the photometry window.
3. Fill the Cell with the sample for 1.5 mL (up to line). (Fig.1)
4. Put the Cell in the cell box and press **[Zero]**. (Fig.2)
5. Add two droplet of K-1 reagent, attach the cap, and shake the Cell 2 to 3 times. (Fig.3)
6. Suck the whole amount of the sample in the Cell into the tube and press **[Start]** at the same time. (Fig.4)
7. Shake the tube in Step 6 by overturning it to right and left for 60 times in 1 minute. (Fig.5)
8. Gently return the solution in the tube to the Cell, set it again in the cell box. (Fig.6)
9. After 20 minutes have elapsed, the concentration will be automatically displayed.

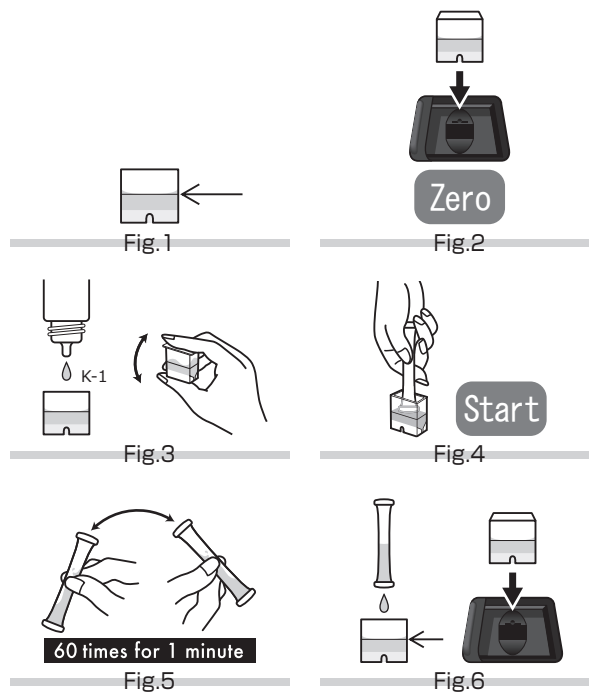

### CAUTION

1. The optimum pH during color development is  $\leq 2$ . Neutralize a sample of pH9 or greater with dilute sulfuric acid.
2. Perform measurement with the sample temperature set to 15 to 30°C.

### Influence of coexisting substance

The stored calibration curve has been created by using the standard solution. If the influence of other substance is considered, check the measurement value by comparing it with the official method or by standard addition method. The right chart is the list of interference data for acceptable level by adding each of the single substances to the standard solution.

Seawater does not affect the measurement.

$\leq 1000\text{mg/L.}$ :  $\text{Al}^{3+}$ , B (III),  $\text{Ca}^{2+}$ ,  $\text{Cl}^-$ ,  $\text{Co}^{2+}$ ,  $\text{Cu}^{2+}$ ,  $\text{F}^-$ ,  $\text{Fe}^{2+}$ ,  $\text{I}^-$ ,  $\text{K}^+$ ,  
 $\text{Mg}^{2+}$ ,  $\text{Mn}^{2+}$ ,  $\text{Na}^+$ ,  $\text{NH}_4^+$ ,  $\text{Ni}^{2+}$ ,  $\text{NO}_3^-$ ,  $\text{PO}_4^{3-}$ ,  $\text{SO}_4^{2-}$ ,  
 $\text{Zn}^{2+}$ , Silica, Phenol  
 $\leq 500\text{mg/L.}$ :  $\text{CN}^-$ , Mo (VI),  $\text{SO}_3^{2-}$   
 $\leq 200\text{mg/L.}$ :  $\text{Cr}^{3+}$   
 $\leq 100\text{mg/L.}$ : Anionic Surfactant  
 $\leq 50\text{mg/L.}$ :  $\text{Fe}^{3+}$   
 $\leq 5\text{mg/L.}$ :  $\text{Ba}^{2+}$   
 $\leq 1\text{mg/L.}$ : V (V)  
 $< 1\text{mg/L.}$ : Cr (VI),  $\text{NO}_2^-$ , Residual Chlorine

### Information on reagent

Refer to the usage that comes with PACKTEST.  
The pH of K-1 reagent and the solution is about  $\leq 2$ .

## KMnO<sub>4</sub> Potassium Permanganate Consumption

Color development: Red purple → Green

Method : Oxidation by potassium permanganate in alkaline

Range : 2.0 – 10.0 mg/L(ppm)

Reagent : LR-COD-B No.44 R-1 (Liquid) , R-2 (Pack) , Neutralizer (Dropper)

Reaction time : 10 min. after R-2 reagent is added.

Cell : PACKTEST Square Cup

Wavelength : 525 nm

### Procedure

1. Press **[KMnO<sub>4</sub>]**.
2. Press **[OK]** to switch to the photometry window.
3. Fill the Cell with the sample for 1.5 mL (up to line) and fill the Round Cell with the sample for 25 mL (up to white line). (Fig.1)
4. Put the Cell in the cell box and press **[Zero]** . Discard the sample in the Cell. (Fig.2)
5. Add 0.5 mL of R-1 reagent into the Round Cell using the supplied syringe, tightly attach the cap, and stir the solution 5 to 6 times. (Fig.3)
6. Add the R-2 reagent into the Round Cell and press **[Start]**. (Fig.4)
7. Tightly attach the cap and shake the Round Cell strongly for 20 seconds. (Fig.5)
8. Within 10 minutes, pour 1.5 mL of the solution in the Round Cell into the Cell that has gone through zero adjustment, and put the Cell in the cell box. (At this point, clean the Cell with the solution contained in the Round Cell.)(Fig.6)
9. After 10 minutes have elapsed, the concentration will be automatically displayed.
10. Dispose of the wastewater in the Round Cell as of after measurement by adding about 8 droplets (0.5 mL) of neutralizer to it and confirming that it has become approximately neutral.

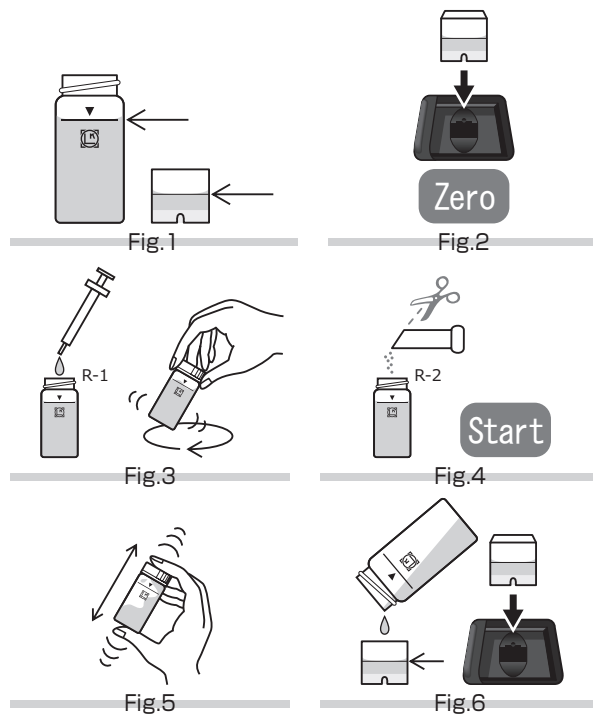

### CAUTION

1. The optimum pH during color development is 12 or more. To an acid sample, add dilute sodium hydroxide solution or the like so as to adjust the pH of the sample to 6 or more.
2. Perform measurement with the sample temperature set to 15 to 25°C .
3. Before filling the Cell with the solution in the measurement procedure Steps 8, rinse the Cup with the solution 2 to 3 times.
4. It is not possible to measure seawater.

### Relationship with official method

While the measurement method of potassium permanganate consumption is stipulated in Standard Methods for the Examination of Water (Japan Water Works Association) or other regulations, the measurement method we offer applies the alkali method (COD<sub>OH</sub>) according to JIS K 0102 19 and allows simple measurement in a short period of time.

In the Standard Methods for the Examination of Water, the amount of potassium permanganate that has been consumed in a boiled water bath for 5 minutes under the acid condition is obtained through titration. On the other hand, the measurement method we offer obtains the amount of potassium permanganate that has been consumed at a room temperature for 10 minutes under the alkali condition from the decrease amount of absorbance.

Verification is conducted by using glucose reference solution, but the degree of oxidation of oxidized substance in the sample by potassium permanganate differs depending on the type and the amount of the substance.

As the values obtained by this measurement method are only approximate values and may not coincide with values obtained by the Standard Methods for the Examination of Water, use this method after obtaining the relationship between those methods.

### Information on reagent

Refer to the enclosed paper to the reagent.

The pH of the solution is 12 or higher and that of the neutralizer is 2 or lower.

The pH of the final wastewater as of after adding neutralizer is around 7. Be sure to dispose of wastewater after checking its pH.

## MAL M-Alkalinity

Color development: Yellow → Green → Blue-green  
Method : Absorptiometry with pH Indicator for Buffering Capacity  
Range : 20 – 80 mg/L(ppm)  
Reagent : WAK-MAL Tube  
Reaction time : 2 min. after drawing sample into the tube.

Cell : PACKTEST Square Cup  
Wavelength : 470 nm, 560 nm

### Procedure

1. Press **[MAL]**.
2. Press **[OK]** to switch to the photometry window.
3. Fill the Cell with the sample for 1.5 mL (up to line). (Fig.1)
4. Put the Cell in the cell box and press **[Zero]**. (Fig.2)
5. Suck the whole amount of the sample in the Cell into the tube and press **[Start]** at the same time. (Fig.3)
6. Shake the tube in Step 5 about 15 times to dissolve the reagent in the tube completely. (Fig.4)
7. Gently return the solution in the tube to the Cell, set it again in the cell box. (Fig.5)
8. After 2 minutes have elapsed, the concentration will be automatically displayed.

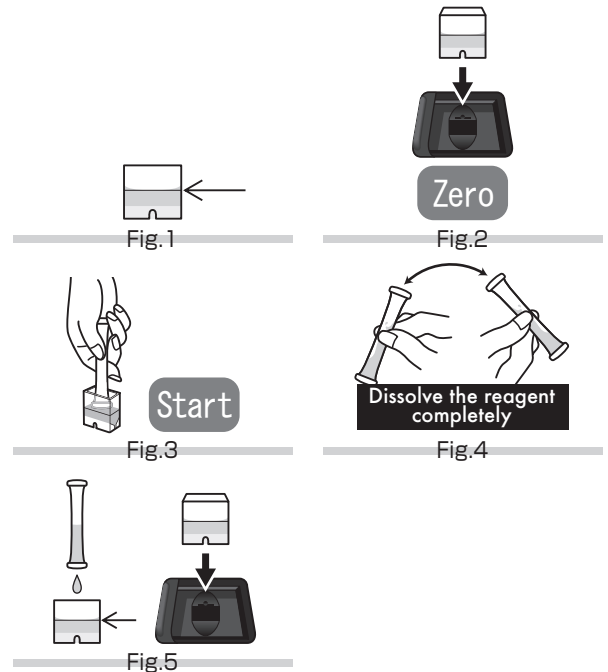

### CAUTION

1. In this method, M-alkalinity (Total alkalinity:  $\text{OH}^-$ ,  $\text{HCO}_3^-$ ,  $\text{CO}_3^{2-}$ , etc.) in the sample is measured.
2. The measurement value is the concentration as calcium carbonate (mg/L as  $\text{CaCO}_3$ ).  
The obtained result can be converted into the equivalent concentration (normality, Unit: meq/L) by multiplying it by 0.020.  
M-alkalinity of the typical natural water is derived from  $\text{HCO}_3^-$  (hydrogencarbonate, bicarbonate). In order to convert the obtained result into the concentration of  $\text{HCO}_3^-$ , multiply it by 1.22.
3. The measurement result may be affected by unclean conditions. Clean up your hands before the measurement.
4. From the definition, M-alkalinity of the sample which is pH below 4.8 is zero. If the sample contains large amount of acid, the color of the solution in the tube may turn to dark yellow or orange.
5. Perform measurement with the sample temperature set to 15 to 40 °C.
6. Larger or smaller sample volume will imply higher or lower value, respectively.  
Use of a measuring pipette or the like to measure the volume of the sample (1.5mL) enables more accurate measurement.

### Influence of coexisting substance

The stored calibration curve has been created by using the standard solution. If the influence of other substance is considered, check the measurement value by comparing it with the official method or by standard addition method.

The right chart is the list of interference data for acceptable level by adding each of the single substances to the standard solution.

Seawater does not affect the measurement, but it may contain alkalinity more than measurement range.

Less than 10% of ethanol does not affect the measurement.

In this method, alkalinity which is derived from phosphate ( $\text{HPO}_4^{2-}$ ,  $\text{PO}_4^{3-}$ ), borate ( $\text{BO}_2^-$ ,  $\text{B}_4\text{O}_7^{2-}$ , etc.) and ammonia ( $\text{NH}_3$ ) is measured, but phosphate which is more than 200 mg/L as  $\text{PO}_4^{3-}$  causes negative error.

$\leq 1000\text{mg/L}$ .; $\text{H}_3\text{BO}_3$ (Boric acid), $\text{Ba}^{2+}$ , $\text{Br}^-$ , $\text{Ca}^{2+}$ , $\text{Cl}^-$ , $\text{I}^-$ , $\text{K}^+$ , $\text{Mg}^{2+}$ , $\text{Mn}^{2+}$ , $\text{Na}^+$ , $\text{NH}_4^+$ , $\text{N}_2\text{H}_5^+$ (Hydrazinium), $\text{NO}_3^-$ , $\text{SO}_4^{2-}$ , Glucose, Phenol
$\leq 200\text{mg/L}$ .; $\text{H}_2\text{PO}_4^-$
$\leq 50\text{mg/L}$ .; Anionic Surfactant
$\leq 20\text{mg/L}$ .; Nonionic surfactant
$\leq 10\text{mg/L}$ .; $\text{F}^-$ , $\text{NO}_2^-$
$\leq 5\text{mg/L}$ .; Residual Chlorine, Cationic Surfactant

### Information on reagent

Refer to the usage that comes with PACKTEST.

## Mn Manganese

Color development: None → Light red → Red  
Method : Potassium Periodate  
Range : 0.5 — 20.0 mg/L(ppm)  
Reagent : WAK-Mn Tube  
Reaction time : 3 min. after drawing sample into the tube.

Cell : PACKTEST Square Cup  
Wavelength : 537 nm

### Procedure

1. Press **[Mn]**.
2. Press **[OK]** to switch to the photometry window.
3. Fill the Cell with the sample for 1.5 mL (up to line). (Fig.1)
4. Put the Cell in the cell box and press **[Zero]**. (Fig.2)
5. Suck the whole amount of the sample in the Cell into the tube and press **[Start]** at the same time. (Fig.3)
6. Lightly shake the tube in Step 5 from 5 to 6 times, return the solution in the tube to the Cell in a gentle manner, set it again in the cell box. (Fig.4)
7. After 3 minutes have elapsed, the concentration will be automatically displayed.

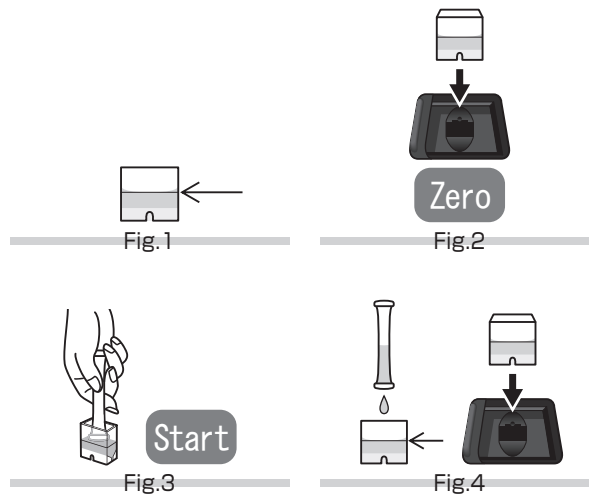

### CAUTION

1. In this method, the concentration of ionized divalent to hexavalent manganese in the sample is measured. If result of manganese concentration including suspension and precipitate is required, dissolve manganese in advance and then perform measurement.
2. To measure the concentration of manganese, including septivalent manganese ions (red), conduct reduction in advance and then perform measurement. Or perform zero adjustment by using a sample whose red color is decolorized by adding a large amount of reducing agent, discard the sample and thoroughly clean the Cell, take the sample again, and perform measurement as usual by sucking the sample into the tube.
3. The optimum pH during color development is 7. If the pH of the sample is not within the range from 5 to 9, neutralize the sample with dilute sulfuric acid or dilute sodium hydroxide solution, etc.
4. Perform measurement with the sample temperature set to 15 to 30°C .

### Influence of coexisting substance

The stored calibration curve has been created by using the standard solution. If the influence of other substance is considered, check the measurement value by comparing it with the official method or by standard addition method.

The right chart is the list of interference data for acceptable level by adding each of the single substances to the standard solution.

Seawater does not affect the measurement.

The existence of a large amount of reductive substance causes a negative measurement error.

For example, in the case of sodium hydrogen sulfite, its coexistence at 10 g/L or more affects the measurement value.

<p>≤ 1000mg/L.: B (III) , Ca<sup>2+</sup> , Cl<sup>-</sup> , F<sup>-</sup> , K<sup>+</sup> , Mg<sup>2+</sup> , Mo (VI) , Na<sup>+</sup> , NH<sub>4</sub><sup>+</sup> , NO<sub>3</sub><sup>-</sup> , PO<sub>4</sub><sup>3-</sup> , SO<sub>4</sub><sup>2-</sup> , Anionic Surfactant , Residual Chlorine , Formaldehyde</p> <p>≤ 500mg/L.: Ni<sup>2+</sup></p> <p>≤ 200mg/L.: Al<sup>3+</sup> , Ba<sup>2+</sup> , Zn<sup>2+</sup></p> <p>≤ 100mg/L.: Cu<sup>2+</sup> , Fe<sup>2+</sup> , Fe<sup>3+</sup></p> <p>≤ 50mg/L.: Cr (VI) , NO<sub>2</sub><sup>-</sup></p> <p>≤ 20mg/L.: CN<sup>-</sup> , Co<sup>2+</sup></p> <p>≤ 5mg/L.: Cr<sup>3+</sup> , I<sup>-</sup> , Phenol</p>
--

### Information on reagent

Refer to the usage that comes with PACKTEST.

The pH of the solution is about 7.

## Mo Molybdenum

Color development: None → Yellow → Brown → Red  
Method : Modified Catechol  
Range : 5 — 150 mg/L(ppm)  
Reagent : WAK-Mo Tube  
Reaction time : 2 min. after drawing sample into the tube.

Cell : PACKTEST Square Cup  
Wavelength : 555 nm

### Procedure

1. Press **[Mo]**.
2. Press **[OK]** to switch to the photometry window.
3. Fill the Cell with the sample for 1.5 mL (up to line). (Fig.1)
4. Put the Cell in the cell box and press **[Zero]**. (Fig.2)
5. Suck the whole amount of the sample in the Cell into the tube and press **[Start]** at the same time. (Fig.3)
6. Lightly shake the tube in Step 5 from 5 to 6 times, return the solution in the tube to the Cell in a gentle manner, set it again in the cell box. (Fig.4)
7. After 2 minutes have elapsed, the concentration will be automatically displayed.

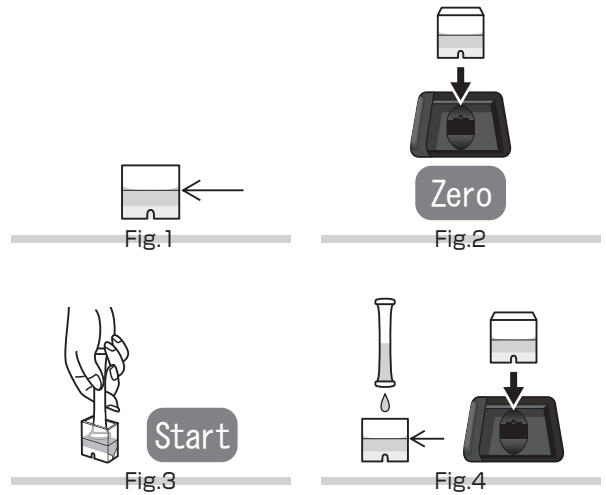

### CAUTION

1. In this method, the concentration of molybdenum(VI) in molybdate ion ( $\text{MoO}_4^{2-}$ ) state is measured and is displayed as a converted value of molybdenum (Mo).  
If result of molybdenum concentration including suspension and precipitate is required, dissolve molybdenum in advance and then perform measurement.
2. It is not possible to measure the concentration of molybdenum sulfide.
3. The obtained result can be converted into the concentration of molybdate ion ( $\text{MoO}_4^{2-}$ ) by multiplying it by 1.67.
4. The optimum pH during color development is 7. If the pH of sample is not within the range from 4 to 9, neutralize the sample with dilute sulfuric acid or dilute sodium hydroxide solution, etc.
5. Perform measurement with the sample temperature set to 15 to 30°C

### Influence of coexisting substance

The stored calibration curve has been created by using the standard solution. If the influence of other substance is considered, check the measurement value by comparing it with the official method or by standard addition method.  
The right chart is the list of interference data for acceptable level by adding each of the single substances to the standard solution.

It is not possible to measure seawater.

≤ 1000mg/L.:  $\text{Cl}^-$ ,  $\text{F}^-$ ,  $\text{I}^-$ ,  $\text{K}^+$ ,  $\text{Mg}^{2+}$ ,  $\text{Na}^+$ ,  $\text{NH}_4^+$ ,  $\text{NO}_2^-$ ,  $\text{NO}_3^-$ ,  $\text{SO}_4^{2-}$ ,  
Residual Chlorine, Anionic Surfactant, Hydrazine, Phenol  
≤ 500mg/L.:  $\text{B (III)}$ ,  $\text{CN}^-$ ,  $\text{SO}_3^{2-}$   
≤ 200mg/L.:  $\text{Ca}^{2+}$ ,  $\text{Cu}^{2+}$ ,  $\text{Mn}^{2+}$ ,  $\text{Zn}^{2+}$   
≤ 100mg/L.:  $\text{Ba}^{2+}$ ,  $\text{Co}^{2+}$ ,  $\text{Cr}^{3+}$ ,  $\text{Ni}^{2+}$   
≤ 10mg/L.:  $\text{Al}^{3+}$ ,  $\text{Cr (VI)}$   
≤ 5mg/L.:  $\text{Fe}^{2+}$ ,  $\text{Fe}^{3+}$   
< 1mg/L.:  $\text{V (V)}$

### Information on reagent

Refer to the usage that comes with PACKTEST.  
The pH of the solution is about 7.

## Ni-D Nickel (DPM)

Color development: None → Light Pink → Pink  
Method : Nioxime  
Range : 0.3 — 10.0 mg/L(ppm)  
Reagent : WAK-Ni (D) Tube  
Reaction time : 2 min. after drawing sample into the tube.

Cell : PACKTEST Square Cup  
Wavelength : 550 nm, 535 nm, 670 nm

### Procedure

1. Press **[Ni-D]**.
2. Press **[OK]** to switch to the photometry window.
3. Fill the Cell with the sample for 1.5 mL (up to line). (Fig.1)
4. Put the Cell in the cell box and press **[Zero]**. (Fig.2)
5. Suck the whole amount of the sample in the Cell into the tube and press **[Start]** at the same time. (Fig.3)
6. Shake the tube in Step 5 by overturning it to right and left for 60 times in 1 minute. (Fig.4)
7. Return the solution in the tube to the Cell in a gentle manner, set it again in the cell box. (Fig.5)
8. After 2 minutes have elapsed, the concentration will be automatically displayed.

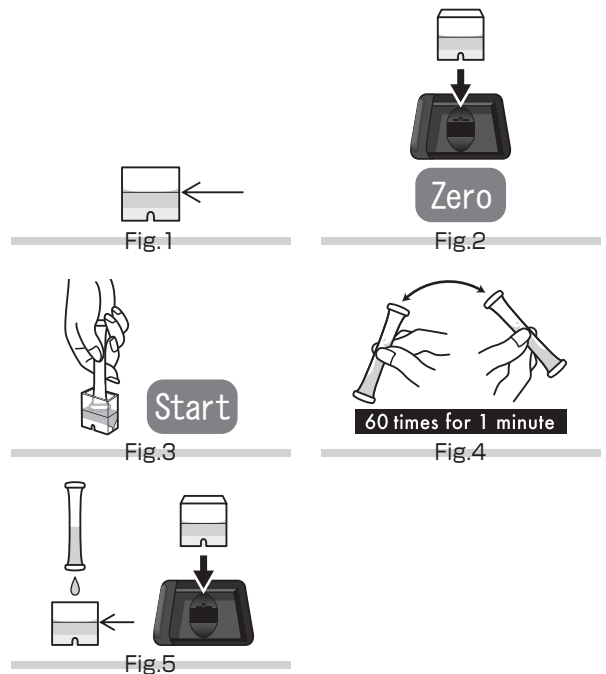

### CAUTION

1. In this method, the concentration of ionized nickel ( $\text{Ni}^{2+}$ ) in the sample is measured. If a result including turbid, deposition, and complex is required, dissolve the target substance in advance and then perform measurement.
2. The optimum pH during color development is 4. If the pH of the sample is not within the range from 4 to 9, neutralize the sample with dilute sulfuric acid or dilute sodium hydroxide solution, etc.
3. Perform measurement with the sample temperature set to 15 to 30°C.

### Influence of coexisting substance

The stored calibration curve has been created by using the standard solution. If the influence of other substance is considered, check the measurement value by comparing it with the official method or by standard addition method. The right chart is the list of interference data for acceptable level by adding each of the single substances to the standard solution.

Seawater does not affect the measurement.

≤ 1000mg/L.: B (III),  $\text{Ca}^{2+}$ ,  $\text{Cl}^-$ ,  $\text{Cr}^{3+}$ ,  $\text{F}^-$ ,  $\text{I}^-$ ,  $\text{K}^+$ ,  $\text{Mg}^{2+}$ ,  $\text{Mn}^{2+}$ , Mo (VI),  
 $\text{Na}^+$ ,  $\text{NH}_4^+$ ,  $\text{NO}_2^-$ ,  $\text{NO}_3^-$ ,  $\text{PO}_4^{3-}$ ,  $\text{SO}_4^{2-}$ ,  $\text{Zn}^{2+}$ , Phenol  
≤ 500mg/L.:  $\text{Ag}^+$ , Residual Chlorine  
≤ 100mg/L.: Anionic Surfactant  
≤ 50mg/L.:  $\text{Ba}^{2+}$ , Cr (VI)  
≤ 20mg/L.:  $\text{Al}^{3+}$ ,  $\text{Co}^{2+}$   
≤ 10mg/L.:  $\text{Fe}^{3+}$   
≤ 3mg/L.:  $\text{Cu}^{2+}$   
≤ 2mg/L.:  $\text{Fe}^{2+}$   
≤ 1mg/L.:  $\text{CN}^-$

### Information on reagent

Refer to the usage that comes with PACKTEST.  
The pH of the solution is about 4.

## NH<sub>4</sub> Ammonium

Color development: None → Light blue → Blue  
Method : Indophenol Blue  
Range : 0.20 — 5.00 mg/L(ppm)  
Reagent : WAK-NH<sub>4</sub> Tube  
Reaction time : 10 min. after drawing sample into the tube.

Cell : PACKTEST Square Cup  
Wavelength : 643 nm, 590 nm

### Procedure

1. Press [NH<sub>4</sub>].
2. Press [OK] to switch to the photometry window.
3. Fill the Cell with the sample for 1.5 mL (up to line). (Fig.1)
4. Put the Cell in the cell box and press [Zero]. (Fig.2)
5. Submerge the aperture of the tube in the sample, and release your finger to suck the whole amount of the sample at once. At the same time, press [Start]. (Fig.3)
6. Shake the tube in Step 5 by overturning it to right and left for 30 times in 30 seconds. (Fig.4)
7. Immediately return the solution in the tube to the Cell in a gentle manner, set it again in the cell box. (Fig.5)
8. After 10 minutes have elapsed, the concentration will be automatically displayed.

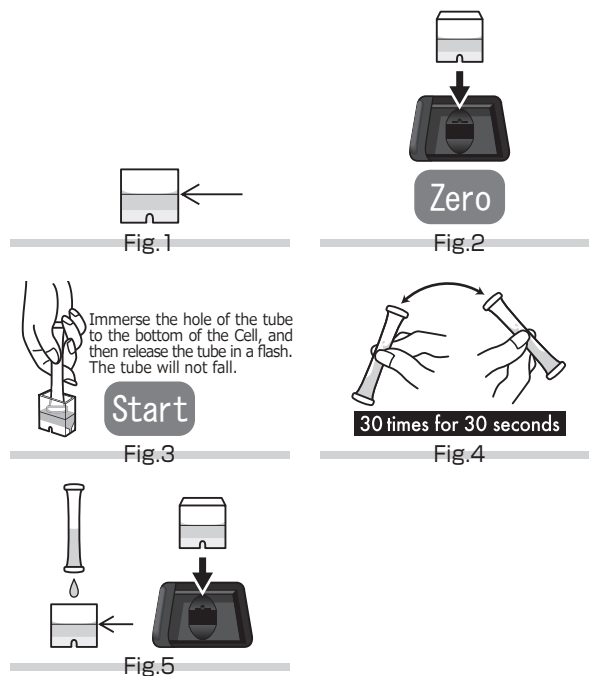

### CAUTION

1. The optimum pH during color development is 13. If the pH of the sample is not within the range from 5 to 13, neutralize the sample with dilute sulfuric acid or dilute sodium hydroxide solution, etc.
2. Perform measurement with the sample temperature set to 15 to 30°C .
3. As the results tend to vary, note the following points to acquire accurate results.
  - To suck the sample into the tube, release your finger while depressing the aperture of the tube against the bottom of the Cell to suck the whole amount of the sample at once.
  - Immediately after having sucked the sample into the tube, start shaking the tube.
  - Shake the tube by overturning it to right and left so that the sample moves all the way to both ends of the tube. Shake the tube for 30 seconds (one reciprocation per second).

### Influence of coexisting substance

The stored calibration curve has been created by using the standard solution. If the influence of other substance is considered, check the measurement value by comparing it with the official method or by standard addition method.

The right chart is the list of interference data for acceptable level by adding each of the single substances to the standard solution.

It is not possible to measure seawater.

To measure seawater or a sample containing a large amount of coexistent substances, perform measurement after separating ammonium ions by distillation because turbid or abnormal color development causes an error.

To perform distillation, procure " Water Analysis Set: Ammonium (Low Range)" (model: WA-NH<sub>4</sub>(L)) or perform distillation according to the JIS K 0102 42.1 distillation method.

#### Except for Heavy metal ions:

- ≤ 1000mg/L.: B (III) , Cl<sup>-</sup> , F<sup>-</sup> , I<sup>-</sup> , K<sup>+</sup> , Na<sup>+</sup> , NO<sub>3</sub><sup>-</sup> , SO<sub>4</sub><sup>2-</sup> , Anionic Surfactant , Residual Chlorine
- ≤ 500mg/L.: Phenol
- ≤ 250mg/L.: PO<sub>4</sub><sup>3-</sup>
- ≤ 100mg/L.: Ca<sup>2+</sup>
- ≤ 50mg/L.: Mg<sup>2+</sup> , NO<sub>2</sub><sup>-</sup>
- ≤ 5mg/L.: Formaldehyde

#### Heavy metal ions:

- ≤ 250mg/L.: Zn<sup>2+</sup>
- ≤ 100mg/L.: Ba<sup>2+</sup> , Cr (VI) , Ni<sup>2+</sup>
- ≤ 50mg/L.: Al<sup>3+</sup>
- ≤ 25mg/L.: Cr<sup>3+</sup> , Mo (VI)
- ≤ 10mg/L.: Ag<sup>+</sup> , Cu<sup>2+</sup>
- ≤ 5mg/L.: Mn<sup>2+</sup>
- ≤ 1mg/L.: Co<sup>2+</sup>
- < 1mg/L.: Fe<sup>2+</sup> , Fe<sup>3+</sup>

### Information on reagent

Refer to the usage that comes with PACKTEST.  
The pH of the solution is about 13.



## NH<sub>4</sub>-N Ammonium-Nitrogen

Color development: None → Light blue → Blue  
Method : Indophenol Blue  
Range : 0.20 — 4.00 mg/L(ppm)  
Reagent : WAK-NH<sub>4</sub> Tube  
Reaction time : 10 min. after drawing sample into the tube.

Cell : PACKTEST Square Cup  
Wavelength : 643 nm, 590 nm

### Procedure

1. Press **[NH<sub>4</sub>-N]**.
2. Press **[OK]** to switch to the photometry window.
3. Fill the Cell with the sample for 1.5 mL (up to line). (Fig.1)
4. Put the Cell in the cell box and press **[Zero]**. (Fig.2)
5. Submerge the aperture of the tube in the sample, and release your finger to suck the whole amount of the sample at once. At the same time, press **[Start]**. (Fig.3)
6. Shake the tube in Step 5 by overturning it to right and left for 30 times in 30 seconds. (Fig.4)
7. Immediately return the solution in the tube to the Cell in a gentle manner, set it again in the cell box. (Fig.5)
8. After 10 minutes have elapsed, the concentration will be automatically displayed.

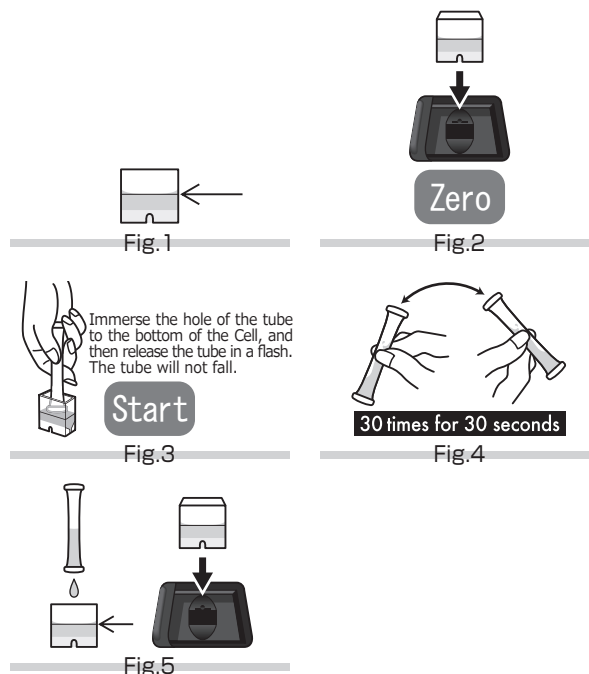

### CAUTION

1. The optimum pH during color development is 13. If the pH of the sample is not within the range from 5 to 13, neutralize the sample with dilute sulfuric acid or dilute sodium hydroxide solution, etc.
2. Perform measurement with the sample temperature set to 15 to 30°C .
3. As the results tend to vary, note the following points to acquire accurate results.
  - To suck the sample into the tube, release your finger while depressing the aperture of the tube against the bottom of the Cell to suck the whole amount of the sample at once.
  - Immediately after having sucked the sample into the tube, start shaking the tube.
  - Shake the tube by overturning it to right and left so that the sample moves all the way to both ends of the tube. Shake the tube for 30 seconds (one reciprocation per second).

### Influence of coexisting substance

The stored calibration curve has been created by using the standard solution. If the influence of other substance is considered, check the measurement value by comparing it with the official method or by standard addition method. The right chart is the list of interference data for acceptable level by adding each of the single substances to the standard solution.

It is not possible to measure seawater.

To measure seawater or a sample containing a large amount of coexistent substances, perform measurement after separating ammonium ions by distillation because turbid or abnormal color development causes an error.

To perform distillation, procure " Water Analysis Set: Ammonium (Low Range)" (model: WA-NH<sub>4</sub>(L)) or perform distillation according to the JIS K 0102 42.1 distillation method.

#### Except for Heavy metal ions:

- ≤ 1000mg/L.: B (III) , Cl<sup>-</sup> , F<sup>-</sup> , I<sup>-</sup> , K<sup>+</sup> , Na<sup>+</sup> , NO<sub>3</sub><sup>-</sup> , SO<sub>4</sub><sup>2-</sup> , Anionic Surfactant , Residual Chlorine
- ≤ 500mg/L.: Phenol
- ≤ 250mg/L.: PO<sub>4</sub><sup>3-</sup>
- ≤ 100mg/L.: Ca<sup>2+</sup>
- ≤ 50mg/L.: Mg<sup>2+</sup> , NO<sub>2</sub><sup>-</sup>
- ≤ 5mg/L.: Formaldehyde

#### Heavy metal ions:

- ≤ 250mg/L.: Zn<sup>2+</sup>
- ≤ 100mg/L.: Ba<sup>2+</sup> , Cr (VI) , Ni<sup>2+</sup>
- ≤ 50mg/L.: Al<sup>3+</sup>
- ≤ 25mg/L.: Cr<sup>3+</sup> , Mo (VI)
- ≤ 10mg/L.: Ag<sup>+</sup> , Cu<sup>2+</sup>
- ≤ 5mg/L.: Mn<sup>2+</sup>
- ≤ 1mg/L.: Co<sup>2+</sup>
- < 1mg/L.: Fe<sup>2+</sup> , Fe<sup>3+</sup>

### Information on reagent

Refer to the usage that comes with PACKTEST.  
The pH of the solution is about 13.

## NH<sub>4</sub>-D Ammonium (Low Range)

Color development: None → Light blue → Blue

Method : Distillation and Indophenol Blue

Range : 0.05 — 2.00 mg/L(ppm)

Reagent : LR-NH<sub>4</sub>-A No.17A R-1 (Liquid) , R-2 (Small Pack) , R-3 (Pack)

Reaction time : 5 min. after R-3 reagent is added.

Additional tool : Water Analysis Set: Ammonium (Low Range) (Model: WA-NH<sub>4</sub>(L))

Usage : Read the instruction supplied with "Water Analysis Set: Ammonium (Low Range)".

Cell : PACKTEST Square Cup

Wavelength : 637 nm, 590 nm

### Procedure

1. Press **[NH<sub>4</sub>-D]**.
2. Press **[OK]** to switch to the photometry window.
3. Adjust the volume of the solution captured through distillation to 25 mL if the volume is less than 25 mL, and then fill the Round Cell with the whole amount of the solution. Fill the Cell with pure water for 1.5 mL (up to line). (Fig.1)
4. Put the Cell in the cell box and press **[Zero]** . Take out the Cell and discard the pure water. (Fig.2)
5. Add 3 mL of the R-1 reagent into the Round Cell using the supplied pipette. (Fig.3)
6. Add the R-2 reagent to the Round Cell, tightly attach the cap, immediately shake the Round Cell strongly for 10 seconds, and wait for 3 minutes. (Fig.4)
7. Add the R-3 reagent to the Round Cell, press **[Start]** , tightly attach the cap, and immediately shake the Round Cell strongly for 10 seconds. (Fig.5)
8. Within 5 minutes, pour the solution in the Round Cell for 1.5 mL into the Cell that has gone through zero adjustment (up to line) and put the Cell in the cell box. (Fig.6)
9. After 5 minutes have elapsed, the concentration will be automatically displayed.

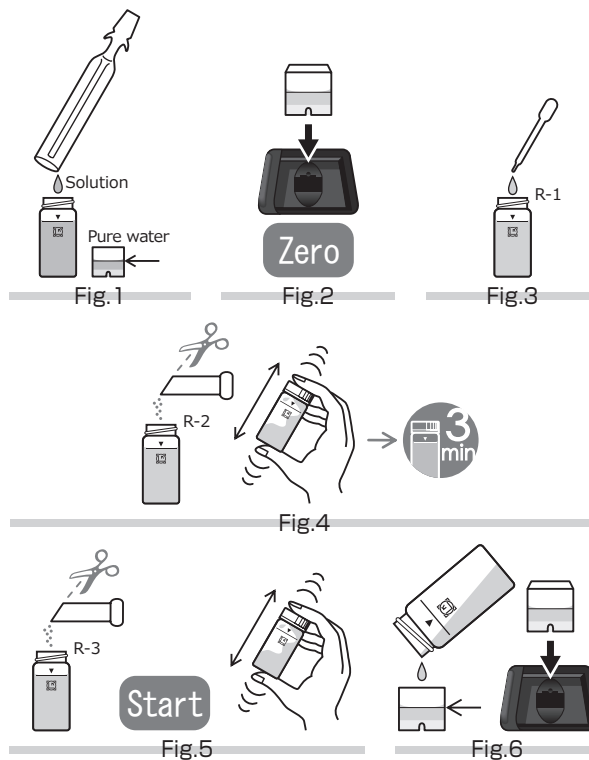

### CAUTION

1. As the glass portion of the distiller becomes hot during distillation, be careful not to get burned.
2. Perform measurement with the solution temperature set to 20°C .  
If the solution temperature is other than 20 °C , multiplying the measurement value by either of the following coefficients can implement correction.  
15°C ··· × 1.2      25°C ··· × 0.75      30°C ··· × 0.65  
If the temperature is 40°C or higher, the color will abnormally develop in red.
3. Use of a measuring pipette or the like instead of the supplied pipette enables more accurate measurement.

### Influence of coexisting substance

Refer to the instruction supplied with "Water Analysis Set: Ammonium (Low Range)".

### Information on reagent

Refer to the enclosed paper to the reagent.

The pH of the solution is about 12.

## NH<sub>4</sub>-N-D Ammonium-Nitrogen (Low Range)

Color development: None → Light blue → Blue

Method : Distillation and Indophenol Blue

Range : 0.05 — 1.50 mg/L(ppm)

Reagent : LR-NH<sub>4</sub>-A No.17A R-1 (Liquid) , R-2 (Small Pack) , R-3 (Pack)

Reaction time : 5 min. after R-3 reagent is added.

Additional tool : Water Analysis Set: Ammonium (Low Range) (Model: WA-NH<sub>4</sub>(L))

Usage : Read the instruction supplied with "Water Analysis Set: Ammonium (Low Range)".

Cell : PACKTEST Square Cup

Wavelength : 637 nm, 590 nm

### Procedure

1. Press **[NH<sub>4</sub>-N-D]**.

2. Press **[OK]** to switch to the photometry window.

3. Adjust the volume of the solution captured through distillation to 25 mL if the volume is less than 25 mL, and then fill the Round Cell with the whole amount of the solution. Fill the Cell with pure water for 1.5 mL (up to line). (Fig.1)

4. Put the Cell in the cell box and press **[Zero]** . Take out the Cell and discard the pure water. (Fig.2)

5. Add 3 mL of the R-1 reagent into the Round Cell using the supplied pipette. (Fig.3)

6. Add the R-2 reagent to the Round Cell, tightly attach the cap, immediately shake the Round Cell strongly for 10 seconds, and wait for 3 minutes. (Fig.4)

7. Add the R-3 reagent to the Round Cell, press **[Start]** , tightly attach the cap, and immediately shake the Round Cell strongly for 10 seconds. (Fig.5)

8. Within 5 minutes, pour the solution in the Round Cell for 1.5 mL into the Cell that has gone through zero adjustment (up to line) and put the Cell in the cell box. (Fig.6)

9. After 5 minutes have elapsed, the concentration will be automatically displayed.

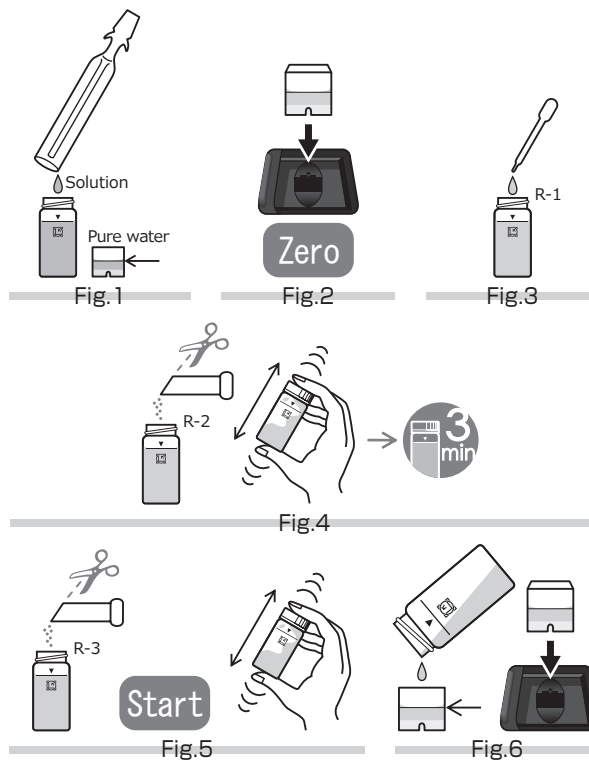

### CAUTION

1. As the glass portion of the distiller becomes hot during distillation, be careful not to get burned.

2. Perform measurement with the solution temperature set to 20°C .

If the solution temperature is other than 20 °C , multiplying the measurement value by either of the following coefficients can implement correction.

15°C ··· ×1.2      25°C ··· ×0.75      30°C ··· ×0.65

If the temperature is 40°C or higher, the color will abnormally develop in red.

3. Use of a measuring pipette or the like instead of the supplied pipette enables more accurate measurement.

### Influence of coexisting substance

Refer to the instruction supplied with "Water Analysis Set: Ammonium (Low Range)".

### Information on reagent

Refer to the enclosed paper to the reagent.

The pH of the solution is about 12.

## NO<sub>2</sub>-C Nitrite (High Range)

Color development: None → Light yellow → Reddish brown  
Method : Griess Romijin  
Range : 3 — 100 mg/L(ppm)  
Reagent : WAK-NO<sub>2</sub> (C) Tube  
Reaction time : 5 min. after drawing sample into the tube.

Cell : PACKTEST Square Cup  
Wavelength : 560 nm

### Procedure

1. Press **[NO<sub>2</sub>-C]**.
2. Press **[OK]** to switch to the photometry window.
3. Fill the Cell with the sample for 1.5 mL (up to line). (Fig.1)
4. Put the Cell in the cell box and press **[Zero]**. (Fig.2)
5. Suck the whole amount of the sample in the Cell into the tube and press **[Start]** at the same time. (Fig.3)
6. Lightly shake the tube in Step 5 from 5 to 6 times, and then wait for reaction for about 4 minutes. (Fig.4)
7. Gently return the solution in the tube to the Cell when the time count down reaches under 1 minute, set it again in the cell box. (Fig.5)
8. After 5 minutes have elapsed, the concentration will be automatically displayed.

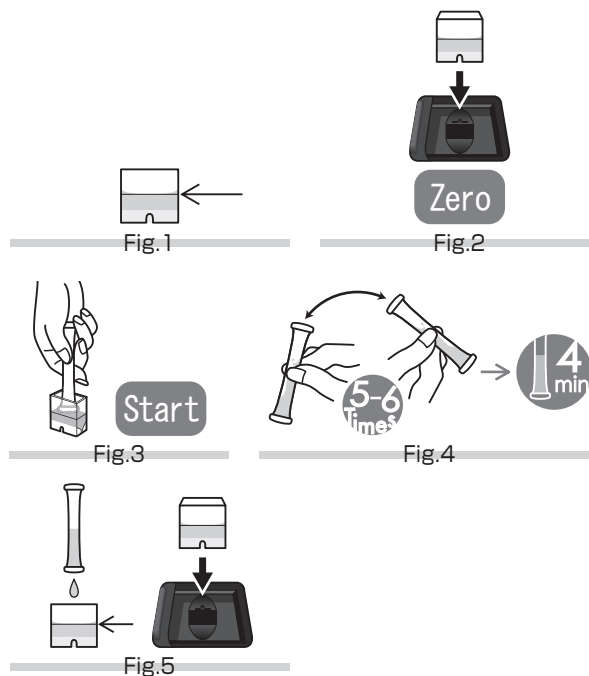

### CAUTION

1. The optimum pH during color development is 3. If the pH of the sample is not within the range from 2 to 9, neutralize the sample with dilute sulfuric acid or dilute sodium hydroxide solution, etc.
2. Perform measurement with the sample temperature set to 15 to 30°C.
3. Note that in this PACKTEST, a large amount of bubbles will be generated. If bubbles are attached to the inner wall of the Cell, remove them as much as possible by, for example, snapping the Cell with your finger.

### Influence of coexisting substance

The stored calibration curve has been created by using the standard solution. If the influence of other substance is considered, check the measurement value by comparing it with the official method or by standard addition method.

The right chart is the list of interference data for acceptable level by adding each of the single substances to the standard solution.

Seawater does not affect the measurement.

Generally, nitrite ions do not coexist with oxidizing substances such as residual chlorine, but if residual chlorine and chloramines exist, they develop their color in red and may be mistaken as nitrite even when nitrite ions do not exist.

#### Except for Heavy metal ions:

- ≤ 100mg/L.: B (III), Ca<sup>2+</sup>, Cl<sup>-</sup>, F<sup>-</sup>, I<sup>-</sup>, K<sup>+</sup>, Mg<sup>2+</sup>, Na<sup>+</sup>, NO<sub>3</sub><sup>-</sup>, PO<sub>4</sub><sup>3-</sup>, SO<sub>4</sub><sup>2-</sup>, Anionic Surfactant, Phenol
- ≤ 50mg/L.: NH<sub>4</sub><sup>+</sup>
- ≤ 5mg/L.: Residual Chlorine

#### Heavy metal ions:

- ≤ 10mg/L.: Al<sup>3+</sup>, Ba<sup>2+</sup>, CN<sup>-</sup>, Co<sup>2+</sup>, Cr<sup>3+</sup>, Cu<sup>2+</sup>, Fe<sup>2+</sup>, Fe<sup>3+</sup>, Mn<sup>2+</sup>, Mo (VI), Ni<sup>2+</sup>, Zn<sup>2+</sup>
- ≤ 1mg/L.: Cr (VI)

### Information on reagent

Refer to the usage that comes with PACKTEST.  
The pH of the solution is about 3.

## NO<sub>2</sub>-N-C Nitrite-Nitrogen (High Range)

Color development: None → Light yellow → Reddish brown  
Method : Griess Romijin  
Range : 1.0 — 30.0 mg/L(ppm)  
Reagent : WAK-NO<sub>2</sub> (C) Tube  
Reaction time : 5 min. after drawing sample into the tube.

Cell : PACKTEST Square Cup  
Wavelength : 560 nm

### Procedure

1. Press **[NO<sub>2</sub>-N-C]**.
2. Press **[OK]** to switch to the photometry window.
3. Fill the Cell with the sample for 1.5 mL (up to line). (Fig.1)
4. Put the Cell in the cell box and press **[Zero]**. (Fig.2)
5. Suck the whole amount of the sample in the Cell into the tube and press **[Start]** at the same time. (Fig.3)
6. Lightly shake the tube in Step 5 from 5 to 6 times, and then wait for reaction for about 4 minutes. (Fig.4)
7. Gently return the solution in the tube to the Cell when the time count down reaches under 1 minute, set it again in the cell box. (Fig.5)
8. After 5 minutes have elapsed, the concentration will be automatically displayed.

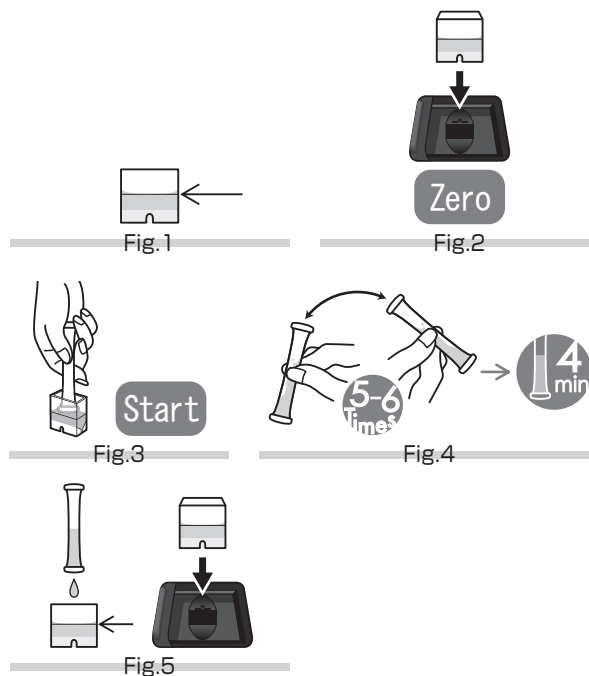

### CAUTION

1. The optimum pH during color development is 3. If the pH of the sample is not within the range from 2 to 9, neutralize the sample with dilute sulfuric acid or dilute sodium hydroxide solution, etc.
2. Perform measurement with the sample temperature set to 15 to 30°C.
3. Note that in this PACKTEST, a large amount of bubbles will be generated. If bubbles are attached to the inner wall of the Cell, remove them as much as possible by, for example, snapping the Cell with your finger.

### Influence of coexisting substance

The stored calibration curve has been created by using the standard solution. If the influence of other substance is considered, check the measurement value by comparing it with the official method or by standard addition method.

The right chart is the list of interference data for acceptable level by adding each of the single substances to the standard solution.

Seawater does not affect the measurement.

Generally, nitrite ions do not coexist with oxidizing substances such as residual chlorine, but if residual chlorine and chloramines exist, they develop their color in red and may be mistaken as nitrite even when nitrite ions do not exist.

#### Except for Heavy metal ions:

- ≤ 100mg/L.: B (III), Ca<sup>2+</sup>, Cl<sup>-</sup>, F<sup>-</sup>, I<sup>-</sup>, K<sup>+</sup>, Mg<sup>2+</sup>, Na<sup>+</sup>, NO<sub>3</sub><sup>-</sup>, PO<sub>4</sub><sup>3-</sup>, SO<sub>4</sub><sup>2-</sup>, Anionic Surfactant, Phenol
- ≤ 50mg/L.: NH<sub>4</sub><sup>+</sup>
- ≤ 5mg/L.: Residual Chlorine

#### Heavy metal ions:

- ≤ 10mg/L.: Al<sup>3+</sup>, Ba<sup>2+</sup>, CN<sup>-</sup>, Co<sup>2+</sup>, Cr<sup>3+</sup>, Cu<sup>2+</sup>, Fe<sup>2+</sup>, Fe<sup>3+</sup>, Mn<sup>2+</sup>, Mo (VI), Ni<sup>2+</sup>, Zn<sup>2+</sup>
- ≤ 1mg/L.: Cr (VI)

### Information on reagent

Refer to the usage that comes with PACKTEST.  
The pH of the solution is about 3.

## NO<sub>2</sub> Nitrite

Color development: None → Light red → Red  
Method : Naphthylethylenediamine  
Range : 0.02 — 1.00 mg/L(ppm)  
Reagent : WAK-NO<sub>2</sub> Tube  
Reaction time : 3 min. after drawing sample into the tube.

Cell : PACKTEST Square Cup  
Wavelength : 539 nm, 570 nm

### Procedure

1. Press **[NO<sub>2</sub>]**.
2. Press **[OK]** to switch to the photometry window.
3. Fill the Cell with the sample for 1.5 mL (up to line). (Fig.1)
4. Put the Cell in the cell box and press **[Zero]**. (Fig.2)
5. Suck the whole amount of the sample in the Cell into the tube and press **[Start]** at the same time. (Fig.3)
6. Lightly shake the tube in Step 5 from 5 to 6 times, return the solution in the tube to the Cell in a gentle manner, set it again in the cell box. (Fig.4)
7. After 3 minutes have elapsed, the concentration will be automatically displayed.

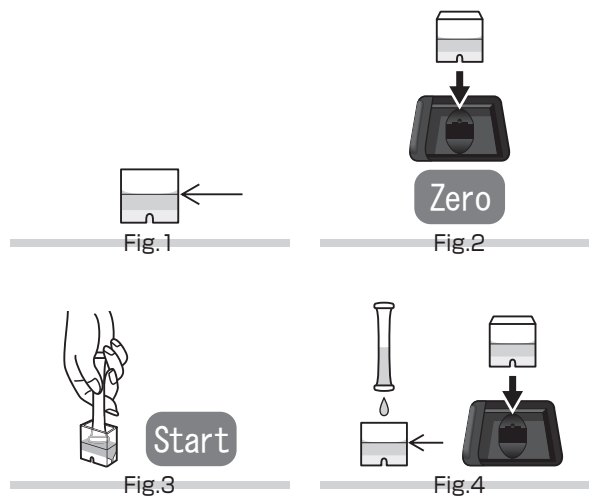

### CAUTION

1. The optimum pH during color development is 3. If the pH of the sample is not within the range from 2 to 9, neutralize the sample with dilute sulfuric acid or dilute sodium hydroxide solution, etc.
2. Perform measurement with the sample temperature set to 15 to 30°C .
3. As nitrite also exists in the air and may be dissolved in pure water, pay due attention during measurement at low concentration.

### Influence of coexisting substance

The stored calibration curve has been created by using the standard solution. If the influence of other substance is considered, check the measurement value by comparing it with the official method or by standard addition method.

The right chart is the list of interference data for acceptable level by adding each of the single substances to the standard solution.

Seawater does not affect the measurement.

Generally, nitrite ions do not coexist with oxidizing substances such as residual chlorine, but if residual chlorine and chloramines exist, they develop their color in red and may be mistaken as nitrite even when nitrite ions do not exist.

<p>≤ 1000mg/L.: B (III) . Ca<sup>2+</sup>, Cl<sup>-</sup>, F<sup>-</sup>, I<sup>-</sup>, K<sup>+</sup>, Mg<sup>2+</sup>, Mn<sup>2+</sup>, Na<sup>+</sup>, NH<sub>4</sub><sup>+</sup>, NO<sub>3</sub><sup>-</sup>, PO<sub>4</sub><sup>3-</sup>, SO<sub>4</sub><sup>2-</sup>, Phenol</p> <p>≤ 500mg/L.: Co<sup>2+</sup></p> <p>≤ 250mg/L.: CN<sup>-</sup>, Cr<sup>3+</sup></p> <p>≤ 100mg/L.: Cu<sup>2+</sup>, Mo (VI), Zn<sup>2+</sup></p> <p>≤ 50mg/L.: Ni<sup>2+</sup></p> <p>≤ 25mg/L.: Fe<sup>2+</sup></p> <p>≤ 10mg/L.: Al<sup>3+</sup>, V (V)</p> <p>≤ 2mg/L.: Cr (VI), Fe<sup>3+</sup></p> <p>&lt; 1mg/L.: Ag<sup>+</sup>, Ba<sup>2+</sup>, Residual Chlorine</p>
---

### Information on reagent

Refer to the usage that comes with PACKTEST.

The pH of the solution is about 3.

## NO<sub>2</sub>-N Nitrite-Nitrogen

Color development: None → Light red → Red  
Method : Naphthylethylenediamine  
Range : 0.010 — 0.300 mg/L(ppm)  
Reagent : WAK-NO<sub>2</sub> Tube  
Reaction time : 3 min. after drawing sample into the tube.

Cell : PACKTEST Square Cup  
Wavelength : 539 nm, 570 nm

### Procedure

1. Press **[NO<sub>2</sub>-N]**.
2. Press **[OK]** to switch to the photometry window.
3. Fill the Cell with the sample for 1.5 mL (up to line). (Fig.1)
4. Put the Cell in the cell box and press **[Zero]**. (Fig.2)
5. Suck the whole amount of the sample in the Cell into the tube and press **[Start]** at the same time. (Fig.3)
6. Lightly shake the tube in Step 5 from 5 to 6 times, return the solution in the tube to the Cell in a gentle manner, set it again in the cell box. (Fig.4)
7. After 3 minutes have elapsed, the concentration will be automatically displayed.

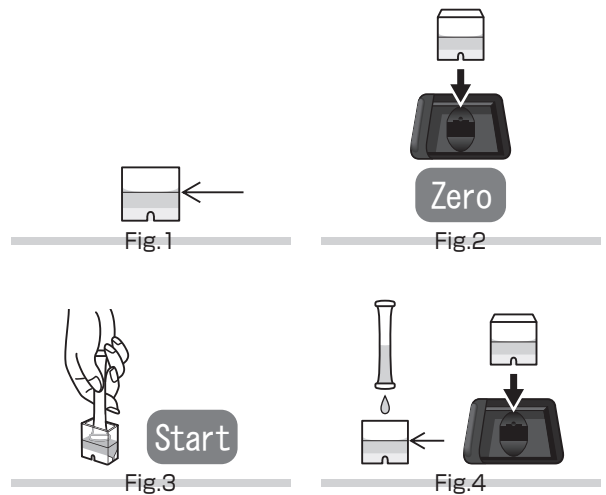

### CAUTION

1. The optimum pH during color development is 3. If the pH of the sample is not within the range from 2 to 9, neutralize the sample with dilute sulfuric acid or dilute sodium hydroxide solution, etc.
2. Perform measurement with the sample temperature set to 15 to 30°C .
3. As nitrite also exists in the air and may be dissolved in pure water, pay due attention during measurement at low concentration.

### Influence of coexisting substance

The stored calibration curve has been created by using the standard solution. If the influence of other substance is considered, check the measurement value by comparing it with the official method or by standard addition method.

The right chart is the list of interference data for acceptable level by adding each of the single substances to the standard solution.

Seawater does not affect the measurement.

Generally, nitrite ions do not coexist with oxidizing substances such as residual chlorine, but if residual chlorine and chloramines exist, they develop their color in red and may be mistaken as nitrite even when nitrite ions do not exist.

<p>≤ 1000mg/L.: B (III) . Ca<sup>2+</sup>, Cl<sup>-</sup>, F<sup>-</sup>, I<sup>-</sup>, K<sup>+</sup>, Mg<sup>2+</sup>, Mn<sup>2+</sup>, Na<sup>+</sup>, NH<sub>4</sub><sup>+</sup>, NO<sub>3</sub><sup>-</sup>, PO<sub>4</sub><sup>3-</sup>, SO<sub>4</sub><sup>2-</sup>, Phenol</p> <p>≤ 500mg/L.: Co<sup>2+</sup></p> <p>≤ 250mg/L.: CN<sup>-</sup>, Cr<sup>3+</sup></p> <p>≤ 100mg/L.: Cu<sup>2+</sup>, Mo (VI), Zn<sup>2+</sup></p> <p>≤ 50mg/L.: Ni<sup>2+</sup></p> <p>≤ 25mg/L.: Fe<sup>2+</sup></p> <p>≤ 10mg/L.: Al<sup>3+</sup>, V (V)</p> <p>≤ 2mg/L.: Cr (VI), Fe<sup>3+</sup></p> <p>&lt; 1mg/L.: Ag<sup>+</sup>, Ba<sup>2+</sup>, Residual Chlorine</p>
---

### Information on reagent

Refer to the usage that comes with PACKTEST.

The pH of the solution is about 3.

## ■ NO<sub>3</sub>-C Nitrate (High Range) ■

In this analyte the procedure should be divided into 2 methods according to the sample state.  
Be careful that each method uses their specified reagent.

### 1.NO<sub>3</sub>-C\_1 Nitrate (High Range) (NO<sub>2</sub><sup>-</sup> ≤ 1mg/L)

Range : 200 – 2000 mg/L (ppm)

Reagent : WAK-NO<sub>3</sub>(C)

Perform the regular Nitrate (High Range) measurement procedure.

### 2.NO<sub>3</sub>-C\_2 Nitrate (High Range) (NO<sub>2</sub><sup>-</sup> 1 – 10mg/L)

Range : 200 – 2000 mg/L (ppm)

Reagent : Pretreatment Reagent for Nitrate (NO<sub>3</sub>-RA), WAK-NO<sub>3</sub>(C)

It is necessary to remove Nitrite by pretreatment reagent before the regular Nitrate (High Range) measurement procedure.



## NO<sub>3</sub>-C\_1 Nitrate (High Range) (NO<sub>2</sub><sup>-</sup> ≤ 1mg/L)

Color development: None → Light yellow → Brown  
Method : Reduction and Griess Romijin  
Range : 200 – 2000 mg/L(ppm)  
Reagent : WAK-NO<sub>3</sub> (C) Tube  
Reaction time : 5 min. after drawing sample into the tube.

Cell : PACKTEST Square Cup  
Wavelength : 560 nm

### Procedure

1. Press [NO<sub>3</sub>-C\_1].
2. Press [OK] to switch to the photometry window.
3. Fill the Cell with the sample for 1.5 mL (up to line). (Fig.1)
4. Put the Cell in the cell box and press [Zero]. (Fig.2)
5. Submerge the aperture of the tube in the sample, and the release your finger to suck the whole amount of the sample at once. At the same time, press [Start]. (Fig.3)
6. Shake the tube in Step 5 by overturning it to right and left for 60 times in 1 minute, and then wait for reaction for about 3 minutes. (Fig.4)
7. Gently return the solution in the tube to the Cell when the time count down reaches under 1 minute, set it again in the cell box. (Fig.5)
8. After 5 minutes have elapsed, the concentration will be automatically displayed.

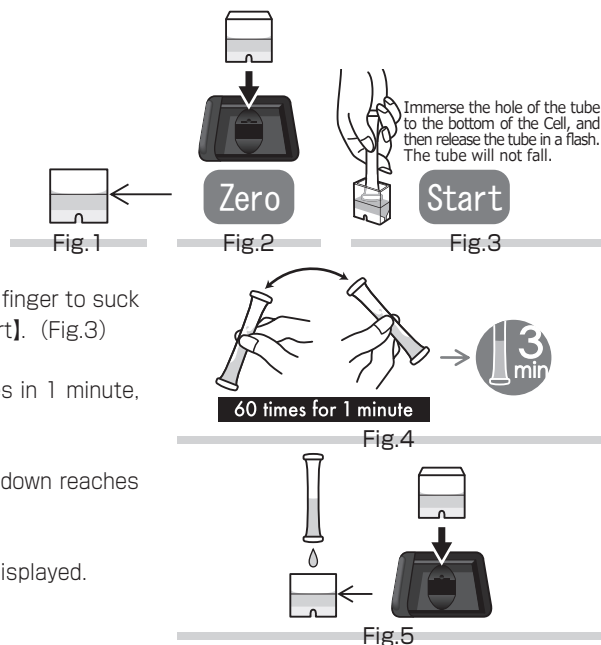

### CAUTION

1. The optimum pH during color development is 3. If the pH of the sample is not within the range from 2 to 9, neutralize the sample with dilute sulfuric acid or dilute sodium hydroxide solution, etc.
2. Perform measurement with the sample temperature set to 20°C .  
If the sample temperature is other than 20 °C , multiplying the measurement value by either of the following coefficients can implement correction.  
10°C · · · ×0.80    30°C · · · ×1.1
3. As the results tend to vary, note the following points to acquire accurate results.
  - To suck the sample into the tube, release your finger while depressing the aperture of the tube against the bottom of the Cell to suck the sample at once.
  - Immediately after having sucked the sample into the tube, start shaking the tube.
  - Shake the tube by overturning it to right and left so that the sample moves all the way to both ends of the tube. Shake the tube for 1 minute (one reciprocation per second).
  - If the tube is shaken intensely, the measurement value will be low.
4. If nitrite ions coexist in the sample at a high concentration, as their color develops stronger than nitrate ions and greatly affects the result, perform measurement by following the procedures for "NO<sub>3</sub>-C\_2 Nitrate (High Range) (NO<sub>2</sub><sup>-</sup> 1 – 10 mg/L)".
5. Note that in this PACKTEST, a large amount of bubbles will be generated. If bubbles are attached to the inner wall of the Cell, remove them as much as possible by, for example, snapping the Cell with your finger.

### Influence of coexisting substance

The stored calibration curve has been created by using the standard solution. If the influence of other substance is considered, check the measurement value by comparing it with the official method or by standard addition method.

The right chart is the list of interference data for acceptable level by adding each of the single substances to the standard solution.

Seawater does not affect the measurement.

Oxidizing substance or reductive substance may affect the measurement.

#### Except for Heavy metal ions:

≤ 100mg/L.: B (III), Ca<sup>2+</sup>, Cl<sup>-</sup>, F<sup>-</sup>, I<sup>-</sup>, K<sup>+</sup>, Mg<sup>2+</sup>, Na<sup>+</sup>, NH<sub>4</sub><sup>+</sup>, PO<sub>4</sub><sup>3-</sup>, SO<sub>4</sub><sup>2-</sup>, Phenol, Anionic Surfactant  
≤ 10mg/L.: Residual Chlorine

#### Heavy metal ions:

≤ 10mg/L.: Al<sup>3+</sup>, Ba<sup>2+</sup>, CN<sup>-</sup>, Cr<sup>3+</sup>, Mn<sup>2+</sup>, Mo (VI), Zn<sup>2+</sup>  
≤ 1mg/L.: Cr (VI), Fe<sup>3+</sup>, Ni<sup>2+</sup>  
< 1mg/L.: Co<sup>2+</sup>, Cu<sup>2+</sup>, Fe<sup>2+</sup>

### Information on reagent

Refer to the usage that comes with PACKTEST.

The pH of the solution is about 3.

## NO<sub>3</sub>-C\_2 Nitrate (High Range) (NO<sub>2</sub><sup>-</sup> 1 – 10mg/L)

Color development: None → Light yellow → Brown

Method : Reduction and Griess Romijin

Range : 200 – 2000 mg/L(ppm)

Reagent : Pretreatment Reagent for Nitrate (Model: NO<sub>3</sub>-RA) (Pack) , WAK-NO<sub>3</sub> (C) Tube

Specified tool : Beaker, Heater

Reaction time : 5 min. after drawing sample into the tube.

Cell : PACKTEST Square Cup

Wavelength : 560 nm

### Pretreatment method

First, remove the nitrite ions mixed in the sample by using pretreatment reagent.

1. Fill a beaker with 30 mL of sample, add Pretreatment Reagent for Nitrate (NO<sub>3</sub>-RA) in the sample, and stir the sample 5 to 6 times. (Fig.1)



Fig.1

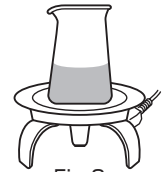

Fig.2

2. Heat the sample, boil it for 2 minutes, and cool it down to 15 to 30°C. (Fig.2)

If the amount of the sample has decreased after cooling down, add pure water up to 30 mL.



Fig.3

3. Fill the Cell with the pretreated sample for 1.5 mL (up to line). (Fig.3)

### Procedure

1. Press [NO<sub>3</sub>-C\_2].

2. Press [OK] to switch to the photometry window.

3. Put the Cell filled with the pretreated sample in the cell box and press [Zero]. (Fig.4)

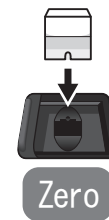

Fig.4

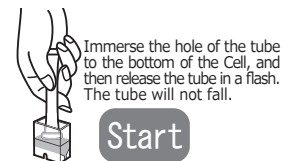

Fig.5

4. Submerge the aperture of the tube in the sample, and release your finger to suck the whole amount of the sample at once. At the same time, press [Start]. (Fig.5)

5. Shake the tube in Step 4 by overturning it to right and left for 60 times in 1 minute, and then wait for reaction for about 3 minutes. (Fig.6)

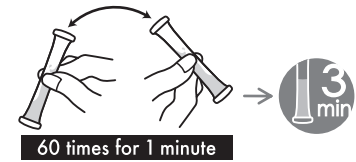

Fig.6

6. Gently return the solution in the tube to the Cell when the time count down reaches under 1 minute, set it again in the cell box. (Fig.7)

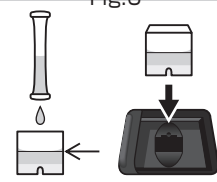

Fig.7

### CAUTION

Refer to "NO<sub>3</sub>-C\_1 Nitrate (High Range) (NO<sub>2</sub><sup>-</sup> ≤ 1mg/L)".

## ■ NO<sub>3</sub>-N-C Nitrate-Nitrogen (High Range) ■

In this analyte the procedure should be divided into 2 methods according to the sample state.  
Be careful that each method uses their specified reagent.

### 1.NO<sub>3</sub>-N-C1 Nitrate-Nitrogen (High Range) (NO<sub>2</sub><sup>-</sup>-N ≤ 0.3mg/L)

Range : 45 – 450 mg/L (ppm)

Reagent : WAK-NO<sub>3</sub>(C)

Perform the regular Nitrate-Nitrogen (High Range) measurement procedure.

### 2.NO<sub>3</sub>-N-C2 Nitrate-Nitrogen (High Range) (NO<sub>2</sub><sup>-</sup>-N 0.3 – 3mg/L)

Range : 45 – 450 mg/L (ppm)

Reagent : Pretreatment Reagent for Nitrate (NO<sub>3</sub>-RA), WAK-NO<sub>3</sub>(C)

It is necessary to remove Nitrite by pretreatment reagent before the regular Nitrate-Nitrogen (High Range) measurement procedure.

## NO<sub>3</sub>-N-C1 Nitrate-Nitrogen (High Range) (NO<sub>2</sub><sup>-</sup>-N ≤ 0.3mg/L)

Color development: None → Light yellow → Brown  
Method : Reduction and Griess Romijin  
Range : 45 – 450 mg/L(ppm)  
Reagent : WAK-NO<sub>3</sub> (C) Tube  
Reaction time : 5 min. after drawing sample into the tube.

Cell : PACKTEST Square Cup  
Wavelength : 560 nm

### Procedure

1. Press [NO<sub>3</sub>-N-C1].
2. Press [OK] to switch to the photometry window.
3. Fill the Cell with the sample for 1.5 mL (up to line). (Fig.1)
4. Put the Cell in the cell box and press [Zero]. (Fig.2)
5. Submerge the aperture of the tube in the sample, and the release your finger to suck the whole amount of the sample at once. At the same time, press [Start]. (Fig.3)
6. Shake the tube in Step 5 by overturning it to right and left for 60 times in 1 minute, and then wait for reaction for about 3 minutes. (Fig.4)
7. Gently return the solution in the tube to the Cell when the time count down reaches under 1 minute, set it again in the cell box. (Fig.5)
8. After 5 minutes have elapsed, the concentration will be automatically displayed.

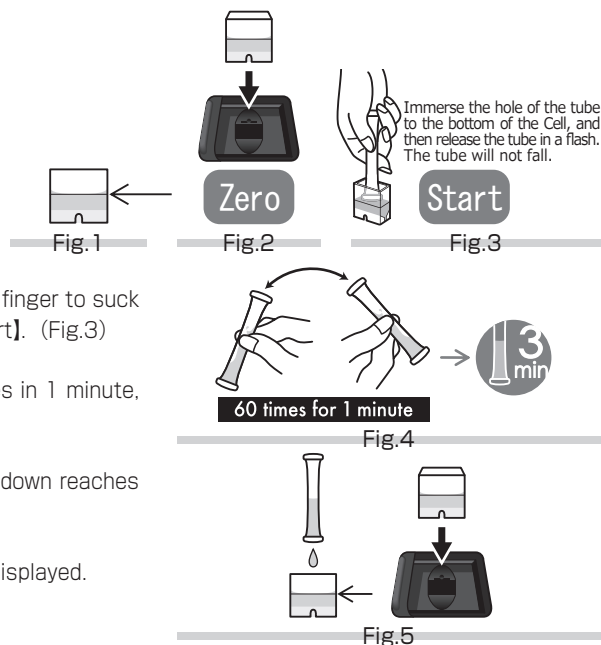

### CAUTION

1. The optimum pH during color development is 3. If the pH of the sample is not within the range from 2 to 9, neutralize the sample with dilute sulfuric acid or dilute sodium hydroxide solution, etc.
2. Perform measurement with the sample temperature set to 20°C .  
If the sample temperature is other than 20 °C , multiplying the measurement value by either of the following coefficients can implement correction.  
10°C · · · ×0.80    30°C · · · ×1.1
3. As the results tend to vary, note the following points to acquire accurate results.
  - To suck the sample into the tube, release your finger while depressing the aperture of the tube against the bottom of the Cell to suck the sample at once.
  - Immediately after having sucked the sample into the tube, start shaking the tube.
  - Shake the tube by overturning it to right and left so that the sample moves all the way to both ends of the tube. Shake the tube for 1 minute (one reciprocation per second).
  - If the tube is shaken intensely, the measurement value will be low.
4. If nitrite ions coexist in the sample at a high concentration, as their color develops stronger than nitrate ions and greatly affects the result, perform measurement by following the procedures for "NO<sub>3</sub>-N-C2 Nitrate-Nitrogen (NO<sub>2</sub><sup>-</sup>-N 0.3 – 3 mg/L)".
5. Note that in this PACKTEST, a large amount of bubbles will be generated. If bubbles are attached to the inner wall of the Cell, remove them as much as possible by, for example, snapping the Cell with your finger.

### Influence of coexisting substance

The stored calibration curve has been created by using the standard solution. If the influence of other substance is considered, check the measurement value by comparing it with the official method or by standard addition method.

The right chart is the list of interference data for acceptable level by adding each of the single substances to the standard solution.

Seawater does not affect the measurement.

Oxidizing substance or reductive substance may affect the measurement.

#### Except for Heavy metal ions:

≤ 100mg/L.: B (III), Ca<sup>2+</sup>, Cl<sup>-</sup>, F<sup>-</sup>, I<sup>-</sup>, K<sup>+</sup>, Mg<sup>2+</sup>, Na<sup>+</sup>, NH<sub>4</sub><sup>+</sup>, PO<sub>4</sub><sup>3-</sup>, SO<sub>4</sub><sup>2-</sup>, Phenol, Anionic Surfactant  
≤ 10mg/L.: Residual Chlorine

#### Heavy metal ions:

≤ 10mg/L.: Al<sup>3+</sup>, Ba<sup>2+</sup>, CN<sup>-</sup>, Cr<sup>3+</sup>, Mn<sup>2+</sup>, Mo (VI), Zn<sup>2+</sup>  
≤ 1mg/L.: Cr (VI), Fe<sup>3+</sup>, Ni<sup>2+</sup>  
< 1mg/L.: Co<sup>2+</sup>, Cu<sup>2+</sup>, Fe<sup>2+</sup>

### Information on reagent

Refer to the usage that comes with PACKTEST.

The pH of the solution is about 3.

## NO<sub>3</sub>-N-C2 Nitrate-Nitrogen (High Range) (NO<sub>2</sub><sup>-</sup>-N 0.3 – 3mg/L)

Color development: None → Light yellow → Brown

Method : Reduction and Griess Romijin

Range : 45 – 450 mg/L(ppm)

Reagent : Pretreatment Reagent for Nitrate (Model: NO<sub>3</sub>-RA) (Pack) , WAK-NO<sub>3</sub> (C) Tube

Specified tool : Beaker, Heater

Reaction time : 5 min. after drawing sample into the tube.

Cell : PACKTEST Square Cup

Wavelength : 560 nm

### Pretreatment method

First, remove the nitrite ions mixed in the sample by using pretreatment reagent.

1. Fill a beaker with 30 mL of sample, add Pretreatment Reagent for Nitrate (NO<sub>3</sub>-RA) in the sample, and stir the sample 5 to 6 times. (Fig.1)

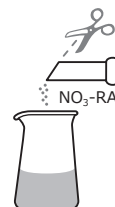

Fig.1

2. Heat the sample, boil it for 2 minutes, and cool it down to 15 to 30°C. (Fig.2)



Fig.2

If the amount of the sample has decreased after cooling down, add pure water up to 30 mL.



Fig.3

3. Fill the Cell with the pretreated sample for 1.5 mL (up to line). (Fig.3)

### Procedure

1. Press [NO<sub>3</sub>-N-C2].

2. Press [OK] to switch to the photometry window.

3. Put the Cell filled with the pretreated sample in the cell box and press [Zero]. (Fig.4)



Fig.4

4. Submerge the aperture of the tube in the sample, and release your finger to suck the whole amount of the sample at once. At the same time, press [Start]. (Fig.5)

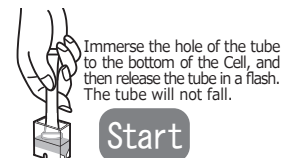

Fig.5

5. Shake the tube in Step 4 by overturning it to right and left for 60 times in 1 minute, and then wait for reaction for about 3 minutes. (Fig.6)

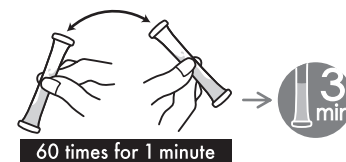

Fig.6

6. Gently return the solution in the tube to the Cell when the time count down reaches under 1 minute, set it again in the cell box. (Fig.7)

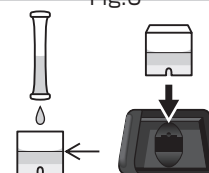

Fig.7

7. After 5 minutes have elapsed, the concentration will be automatically displayed.

### CAUTION

Refer to "NO<sub>3</sub>-N-C1 Nitrate-Nitrogen (High Range) (NO<sub>2</sub><sup>-</sup>-N ≤0.3 mg/L)".

## ■ NO<sub>3</sub> Nitrate

In this analyte the procedure should be divided into 3 methods according to the sample state.  
Be careful that each method uses their specified reagent.

### 1.NO<sub>3\_1</sub> Nitrate (NO<sub>2</sub><sup>-</sup> = 0mg/L)

Range : 1.0 – 25.0 mg/L (ppm)

Reagent : WAK-NO<sub>3</sub>

Perform the regular Nitrate measurement procedure.

### 2.NO<sub>3\_2</sub> Nitrate (NO<sub>2</sub><sup>-</sup> ≤ 0.2mg/L)

Range : 1.0 – 25.0 mg/L (ppm)

Reagent : WAK-NO<sub>2</sub>, WAK-NO<sub>3</sub>

It is necessary to zero adjustment with the color-developed sample with reagent for Nitrite (WAK-NO<sub>2</sub>) before the regular Nitrate measurement procedure.

### 3.NO<sub>3\_3</sub> Nitrate (NO<sub>2</sub><sup>-</sup> 0.2 – 5mg/L)

Range : 1.0 – 25.0 mg/L (ppm)

Reagent : Pretreatment Reagent for Nitrate (NO<sub>3</sub>-RA), WAK-NO<sub>3</sub>(C)

It is necessary to remove Nitrite by pretreatment reagent before the regular Nitrate measurement procedure.

## NO<sub>3</sub>\_1 Nitrate (NO<sub>2</sub><sup>-</sup> = 0mg/L)

Color development: None → Light red → Red  
Method : Reduction and Naphthylethylenediamine  
Range : 1.0 — 25.0 mg/L(ppm)  
Reagent : WAK-NO<sub>3</sub> Tube  
Reaction time : 5 min. after drawing sample into the tube.

Cell : PACKTEST Square Cup  
Wavelength : 539 nm, 580 nm

### Procedure

1. Press [NO<sub>3</sub>\_1].
2. Press [OK] to switch to the photometry window.
3. Fill the Cell with the sample for 1.5 mL (up to line). (Fig.1)
4. Put the Cell in the cell box and press [Zero]. (Fig.2)
5. Submerge the aperture of the tube in the sample, and the release your finger to suck the whole amount of the sample at once. At the same time, press [Start]. (Fig.3)
6. Shake the tube in Step 5 by overturning it to right and left for 60 times in 1 minute. (Fig.4)
7. Immediately return the solution in the tube to the Cell in a gentle manner, set it again in the cell box. (Fig.5)
8. After 5 minutes have elapsed, the concentration will be automatically displayed.

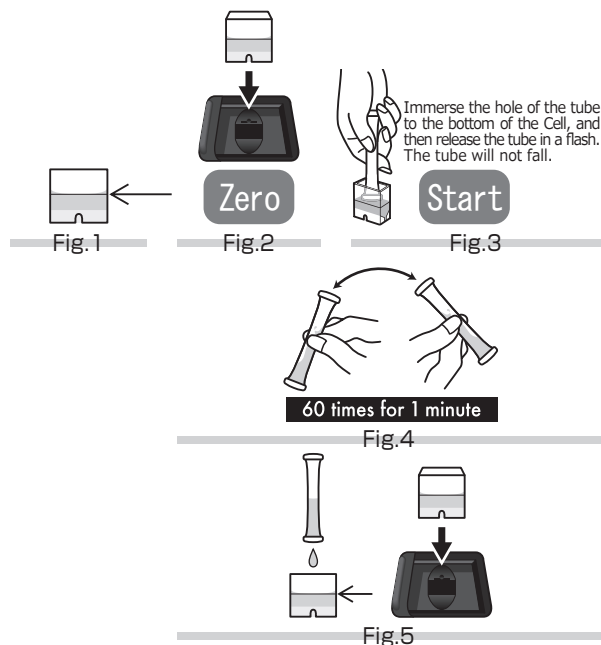

### CAUTION

1. The optimum pH during color development is 3. If the pH of the sample is not within the range from 2 to 9, neutralize the sample with dilute sulfuric acid or dilute sodium hydroxide solution, etc.
2. Perform measurement with the sample temperature set to 15 to 30°C .
3. As the results tend to vary, note the following points to acquire accurate results.
  - To suck the sample into the tube, release your finger while depressing the aperture of the tube against the bottom of the Cell to suck the sample at once.
  - Immediately after having sucked the sample into the tube, start shaking the tube.
  - Shake the tube by overturning it to right and left so that the sample moves all the way to both ends of the tube. Shake the tube for 1 minute (one reciprocation per second).
4. If nitrite ions coexist in the sample, as their color develops stronger than nitrate ions and greatly affects the result, perform measurement by following the procedures.
  - "NO<sub>3</sub>\_2 Nitrate (NO<sub>2</sub><sup>-</sup> ≤ 0.2 mg/L)"
  - "NO<sub>3</sub>\_3 Nitrate (NO<sub>2</sub><sup>-</sup> 0.2 — 5 mg/L)"

### Influence of coexisting substance

The stored calibration curve has been created by using the standard solution. If the influence of other substance is considered, check the measurement value by comparing it with the official method or by standard addition method.

The right chart is the list of interference data for acceptable level by adding each of the single substances to the standard solution.

It is not possible to measure seawater.

Oxidizing substance or reductive substance may affect the measurement.

≤ 1000mg/L.: B (III) , K<sup>+</sup> , Mg<sup>2+</sup> , Mn<sup>2+</sup> , Na<sup>+</sup> , NH<sub>4</sub><sup>+</sup> , PO<sub>4</sub><sup>3-</sup> , Phenol  
≤ 800mg/L.: Cl<sup>-</sup>  
≤ 200mg/L.: Al<sup>3+</sup> , Ca<sup>2+</sup> , F<sup>-</sup> , Ni<sup>2+</sup>  
≤ 100mg/L.: CN<sup>-</sup> , Fe<sup>3+</sup>  
≤ 50mg/L.: Co<sup>2+</sup> , Cr<sup>3+</sup> , Fe<sup>2+</sup> , Zn<sup>2+</sup>  
≤ 5mg/L.: Ba<sup>2+</sup> , I<sup>-</sup>  
≤ 1mg/L.: Cu<sup>2+</sup> , Mo (VI) , Sn<sup>2+</sup> , Residual Chlorine  
≤ 0.5mg/L.: Cr (VI) , SO<sub>3</sub><sup>2-</sup>  
< 1mg/L.: NO<sub>2</sub><sup>-</sup>

### Information on reagent

Refer to the usage that comes with PACKTEST.

The pH of the solution is about 3.

## NO<sub>3</sub>\_2 Nitrate (NO<sub>2</sub><sup>-</sup> ≤ 0.2mg/L)

Color development: None → Light red → Red  
Method : Reduction and Naphthylethylenediamine  
Range : 1.0 — 25.0 mg/L(ppm)  
Reagent : WAK-NO<sub>2</sub> Tube, WAK-NO<sub>3</sub> Tube  
Reaction time : 5 min. after drawing sample into the tube.

Cell : PACKTEST Square Cup  
Wavelength : 539 nm, 580 nm

### Pretreatment method

First, develop the color of nitrite ions.

1. Fill the Cell with the sample for 1.5 mL (up to line). (Fig.1)
2. Suck the whole amount of the sample in the Cell into the tube (WAK-NO<sub>2</sub>) and then lightly shake the tube 5 to 6 times. (Fig.2)
3. Return the solution to the Cell and wait for 3 minutes. (Fig.3)

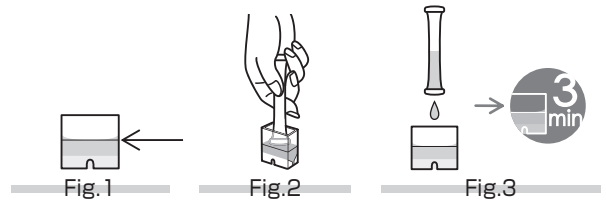

### Procedure

1. Press [NO<sub>3</sub>\_2].
2. Press [OK] to switch to the photometry window.
3. Put the Cell containing color-developed nitrite in the cell box and press [Zero]. (Fig.4)
4. Take the Cell out of the cell box, empty it, and clean it with pure water. (Fig.5)
5. Fill the Cell with the sample for 1.5 mL (up to line). (Fig.6)
6. Submerge the aperture of the tube (WAK-NO<sub>3</sub>) in the sample, and then release your finger to suck the whole amount of sample at once. At the same time, press [Start]. (Fig.7)
7. Shake the tube in Step 6 by overturning it to right and left for 60 times in 1 minute. (Fig.8)
8. Return the solution in the tube to the Cell in a gentle manner, set it again in the cell box. (Fig.9)
9. After 5 minutes have elapsed, the concentration will be automatically displayed.

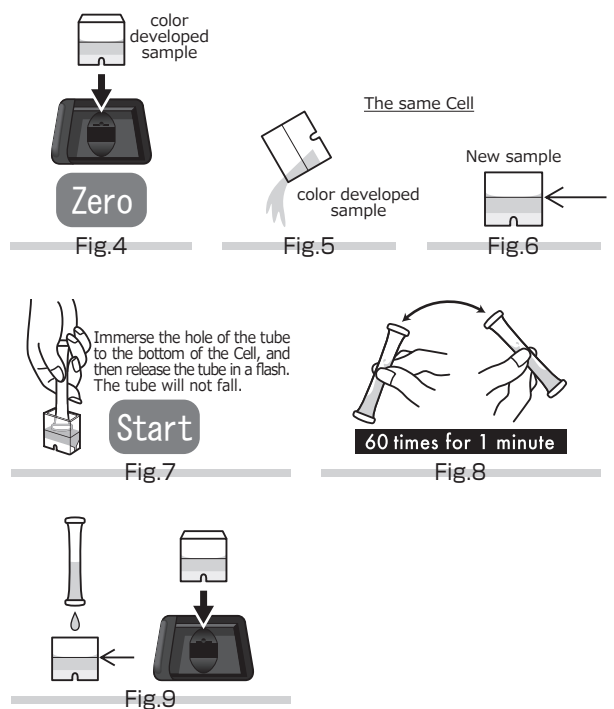

### CAUTION

Refer to "NO<sub>3</sub>\_1 Nitrate (NO<sub>2</sub><sup>-</sup> = 0 mg/L)".



## NO<sub>3</sub>\_3 Nitrate (NO<sub>2</sub><sup>-</sup> 0.2 – 5mg/L)

Color development: None → Light red → Red

Method : Reduction and Naphthylethylenediamine

Range : 1.0 – 25.0 mg/L(ppm)

Reagent : Pretreatment Reagent for Nitrate (Model: NO<sub>3</sub>-RA) (Pack) , WAK-NO<sub>3</sub> Tube

Specified tool : Beaker, Heater

Reaction time : 5 min. after drawing sample into the tube.

Cell : PACKTEST Square Cup

Wavelength : 539 nm, 580 nm

### Pretreatment method

First, remove the nitrite ions mixed in the sample by using pretreatment reagent.

1. Fill a beaker with 30 mL of sample, add Pretreatment Reagent for Nitrate (NO<sub>3</sub>-RA) in the sample, and stir the sample 5 to 6 times. (Fig.1)



Fig.1



Fig.2

2. Heat the sample, boil it for 2 minutes, and cool it down to 15 to 30°C. (Fig.2)

If the amount of the sample has decreased after cooling down, add pure water up to 30 mL.



Fig.3

3. Fill the Cell with the pretreated sample for 1.5 mL (up to line). (Fig.3)

### Procedure

1. Press [NO<sub>3</sub>\_3].

2. Press [OK] to switch to the photometry window.

3. Put the Cell filled with the pretreated sample in the cell box and press [Zero]. (Fig.4)

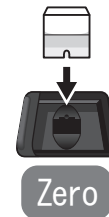

Fig.4

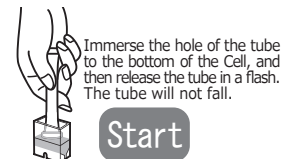

Fig.5

4. Submerge the aperture of the tube in the sample, and the release your finger to suck the whole amount of the sample at once. At the same time, press [Start]. (Fig.5)

5. Shake the tube in Step 4 by overturning it to right and left for 60 times in 1 minute, and then wait for reaction for about 3 minutes. (Fig.6)

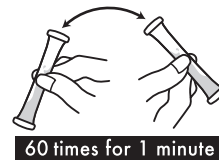

Fig.6

6. Gently return the solution in the tube to the Cell when the time count down reaches under 1 minute, set it again in the cell box. (Fig.7)

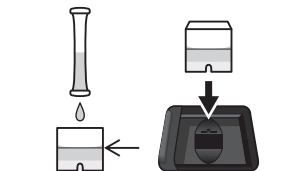

Fig.7

7. After 5 minutes have elapsed, the concentration will be automatically displayed.

### CAUTION

Refer to "NO<sub>3</sub>\_1 Nitrate (NO<sub>2</sub><sup>-</sup> = 0 mg/L)".

## ■ NO<sub>3</sub>-N Nitrate-Nitrogen ■

In this analyte the procedure should be divided into 3 methods according to the sample state.  
Be careful that each method uses their specified reagent.

### 1.NO<sub>3</sub>-N\_1 Nitrate-Nitrogen (NO<sub>2</sub><sup>-</sup>-N = 0mg/L)

Range : 0.20 – 5.80 mg/L (ppm)

Reagent : WAK-NO<sub>3</sub>

Perform the regular Nitrate-Nitrogen measurement procedure.

### 2.NO<sub>3</sub>-N\_2 Nitrate-Nitrogen (NO<sub>2</sub><sup>-</sup>-N ≤ 0.06mg/L)

Range : 0.20 – 5.80 mg/L (ppm)

Reagent : WAK-NO<sub>2</sub>, WAK-NO<sub>3</sub>

It is necessary to zero adjustment with the color-developed sample with reagent for Nitrite (WAK-NO<sub>2</sub>) before the regular Nitrate-Nitrogen measurement procedure.

### 3.NO<sub>3</sub>-N\_3 Nitrate-Nitrogen (NO<sub>2</sub><sup>-</sup>-N 0.06 – 1.5mg/L)

Range : 0.20 – 5.80 mg/L (ppm)

Reagent : Pretreatment Reagent for Nitrate (NO<sub>3</sub>-RA), WAK-NO<sub>3</sub>

It is necessary to remove Nitrite by pretreatment reagent before the regular Nitrate-Nitrogen measurement procedure.

## NO<sub>3</sub>-N\_1 Nitrate-Nitrogen (NO<sub>2</sub><sup>-</sup>-N = 0mg/L)

Color development: None → Light red → Red  
Method : Reduction and Naphthylethylenediamine  
Range : 0.20 — 5.80 mg/L(ppm)  
Reagent : WAK-NO<sub>3</sub> Tube  
Reaction time : 5 min. after drawing sample into the tube.

Cell : PACKTEST Square Cup  
Wavelength : 539 nm, 580 nm

### Procedure

1. Press [NO<sub>3</sub>-N\_1].
2. Press [OK] to switch to the photometry window.
3. Fill the Cell with the sample for 1.5 mL (up to line). (Fig.1)
4. Put the Cell in the cell box and press [Zero]. (Fig.2)
5. Submerge the aperture of the tube in the sample, and the release your finger to suck the whole amount of the sample at once. At the same time, press [Start]. (Fig.3)
6. Shake the tube in Step 5 by overturning it to right and left for 60 times in 1 minute. (Fig.4)
7. Immediately return the solution in the tube to the Cell in a gentle manner, set it again in the cell box. (Fig.5)
8. After 5 minutes have elapsed, the concentration will be automatically displayed.

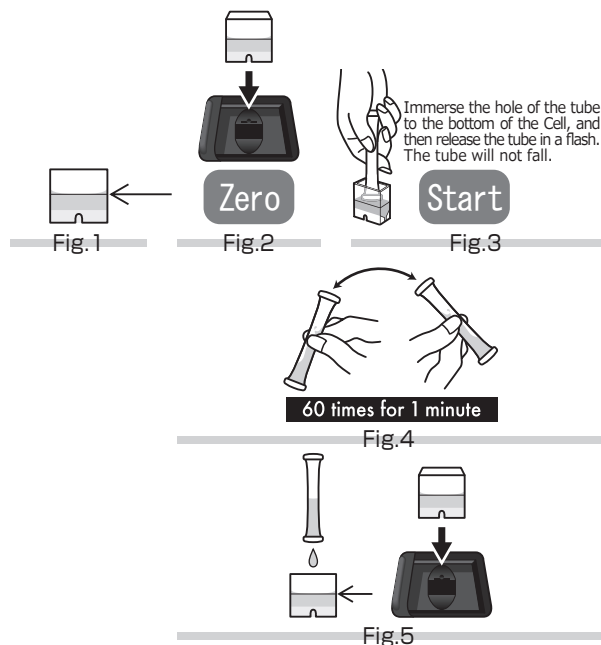

### CAUTION

1. The optimum pH during color development is 3. If the pH of the sample is not within the range from 2 to 9, neutralize the sample with dilute sulfuric acid or dilute sodium hydroxide solution, etc.
2. Perform measurement with the sample temperature set to 15 to 30°C .
3. As the results tend to vary, note the following points to acquire accurate results.
  - To suck the sample into the tube, release your finger while depressing the aperture of the tube against the bottom of the Cell to suck the sample at once.
  - Immediately after having sucked the sample into the tube, start shaking the tube.
  - Shake the tube by overturning it to right and left so that the sample moves all the way to both ends of the tube. Shake the tube for 1 minute (one reciprocation per second).
4. If nitrite ions coexist in the sample, as their color develops stronger than nitrate ions and greatly affects the result, perform measurement by following the procedures.

"NO<sub>3</sub>-N\_2 Nitrate-Nitrogen (NO<sub>2</sub><sup>-</sup>-N ≤ 0.06 mg/L)"

"NO<sub>3</sub>-N\_3 Nitrate-Nitrogen (NO<sub>2</sub><sup>-</sup>-N 0.06 — 1.5 mg/L)"

### Influence of coexisting substance

The stored calibration curve has been created by using the standard solution. If the influence of other substance is considered, check the measurement value by comparing it with the official method or by standard addition method.

The right chart is the list of interference data for acceptable level by adding each of the single substances to the standard solution.

It is not possible to measure seawater.

Oxidizing substance or reductive substance may affect the measurement.

≤ 1000mg/L.: B (III) , K<sup>+</sup> , Mg<sup>2+</sup> , Mn<sup>2+</sup> , Na<sup>+</sup> , NH<sub>4</sub><sup>+</sup> , PO<sub>4</sub><sup>3-</sup> , Phenol  
≤ 800mg/L.: Cl<sup>-</sup>  
≤ 200mg/L.: Al<sup>3+</sup> , Ca<sup>2+</sup> , F<sup>-</sup> , Ni<sup>2+</sup>  
≤ 100mg/L.: CN<sup>-</sup> , Fe<sup>3+</sup>  
≤ 50mg/L.: Co<sup>2+</sup> , Cr<sup>3+</sup> , Fe<sup>2+</sup> , Zn<sup>2+</sup>  
≤ 5mg/L.: Ba<sup>2+</sup> , I<sup>-</sup>  
≤ 1mg/L.: Cu<sup>2+</sup> , Mo (VI) , Sn<sup>2+</sup> , Residual Chlorine  
≤ 0.5mg/L.: Cr (VI) , SO<sub>3</sub><sup>2-</sup>  
< 1mg/L.: NO<sub>2</sub><sup>-</sup>

### Information on reagent

Refer to the usage that comes with PACKTEST.

The pH of the solution is about 3.

## NO<sub>3</sub>-N\_2 Nitrate-Nitrogen (NO<sub>2</sub><sup>-</sup>-N ≤ 0.06mg/L)

Color development: None → Light red → Red  
Method : Reduction and Naphthylethylenediamine  
Range : 0.20 — 5.80 mg/L(ppm)  
Reagent : WAK-NO<sub>2</sub> Tube, WAK-NO<sub>3</sub> Tube  
Reaction time : 5 min. after drawing sample into the tube.

Cell : PACKTEST Square Cup  
Wavelength : 539 nm, 580 nm

### Pretreatment method

First, develop the color of nitrite ions.

1. Fill the Cell with the sample for 1.5 mL (up to line). (Fig.1)
2. Suck the whole amount of the sample in the Cell into the tube (WAK-NO<sub>2</sub>) and then lightly shake the tube 5 to 6 times. (Fig.2)
3. Return the solution to the Cell and wait for 3 minutes. (Fig.3)

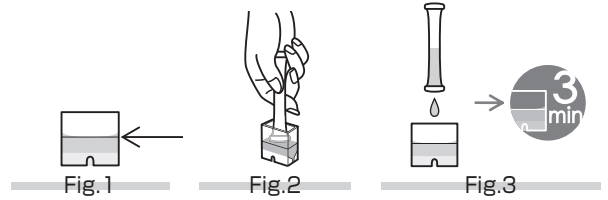

### Procedure

1. Press [NO<sub>3</sub>-N\_2].
2. Press [OK] to switch to the photometry window.
3. Put the Cell containing color-developed nitrite in the cell box and press [Zero]. (Fig.4)
4. Take the Cell out of the cell box, empty it, and clean it with pure water. (Fig.5)
5. Fill the Cell with the sample for 1.5 mL (up to line). (Fig.6)
6. Submerge the aperture of the tube (WAK-NO<sub>3</sub>) in the sample, and then release your finger to suck the whole amount of sample at once. At the same time, press [Start]. (Fig.7)
7. Shake the tube in Step 6 by overturning it to right and left for 60 times in 1 minute. (Fig.8)
8. Return the solution in the tube to the Cell in a gentle manner, set it again in the cell box. (Fig.9)
9. After 5 minutes have elapsed, the concentration will be automatically displayed.

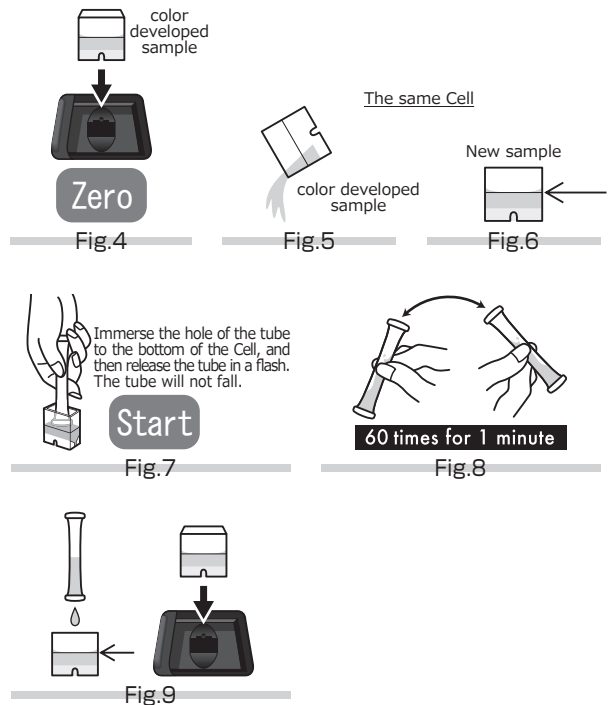

### CAUTION

Refer to "NO<sub>3</sub>-N\_1 Nitrate-Nitrogen (NO<sub>2</sub><sup>-</sup>-N = 0 mg/L)".

## NO<sub>3</sub>-N\_3 Nitrate-Nitrogen (NO<sub>2</sub><sup>-</sup>-N 0.06 – 1.5mg/L)

Color development: None → Light red → Red

Method : Reduction and Naphthylethylenediamine

Range : 0.20 – 5.80 mg/L(ppm)

Reagent : Pretreatment Reagent for Nitrate (Model: NO<sub>3</sub>-RA) (Pack) , WAK-NO<sub>3</sub> Tube

Specified tool : Beaker, Heater

Reaction time : 5 min. after drawing sample into the tube.

Cell : PACKTEST Square Cup

Wavelength : 539 nm, 580 nm

### Pretreatment method

First, remove the nitrite ions mixed in the sample by using pretreatment reagent.

1. Fill a beaker with 30 mL of sample, add Pretreatment Reagent for Nitrate (NO<sub>3</sub>-RA) in the sample, and stir the sample 5 to 6 times. (Fig.1)



Fig.1

2. Heat the sample, boil it for 2 minutes, and cool it down to 15 to 30°C. (Fig.2)



Fig.2

If the amount of the sample has decreased after cooling down, add pure water up to 30 mL.

3. Fill the Cell with the pretreated sample for 1.5 mL (up to line). (Fig.3)



Fig.3

### Procedure

1. Press [NO<sub>3</sub>-N\_3].

2. Press [OK] to switch to the photometry window.

3. Put the Cell filled with the pretreated sample in the cell box and press [Zero]. (Fig.4)

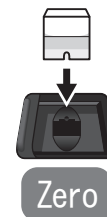

Fig.4

4. Submerge the aperture of the tube in the sample, and release your finger to suck the whole amount of the sample at once. At the same time, press [Start]. (Fig.5)

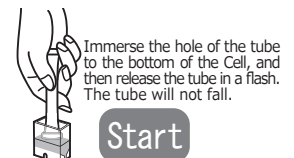

Fig.5

5. Shake the tube in Step 4 by overturning it to right and left for 60 times in 1 minute, and then wait for reaction for about 3 minutes. (Fig.6)

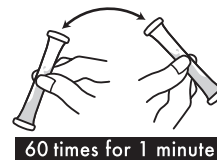

Fig.6

6. Gently return the solution in the tube to the Cell when the time count down reaches under 1 minute, set it again in the cell box. (Fig.7)

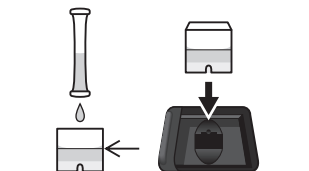

Fig.7

7. After 5 minutes have elapsed, the concentration will be automatically displayed.

### CAUTION

Refer to "NO<sub>3</sub>-N\_1 Nitrate-Nitrogen (NO<sub>2</sub><sup>-</sup>-N = 0 mg/L)".

## OIL-M Mineral Oil in Water

Color development: Transparent → White Turbidity

Method : Oil Concentration-Turbidimetry with PNIPAAm

Range : 5.0 — 60.0 mg/L(ppm) (resolution : 0.5 mg/L)

Reagent : WA-OIL-R

Reaction time : 0 min.

Additional tool : Water Analysis Reagent Set: Oil (Model: WA-OIL)

Usage : Read the instruction supplied with "Water Analysis Reagent Set: Oil".

Cell : PACKTEST Square Cup

Wavelength : 660 nm

### Procedure

1. Press **[OIL-M]**.
2. Press **[OK]** to switch to the photometry window.
3. Fill the Cell with pure water (or tap water) for 1.5 mL (up to line). (Fig.1)
4. Put the Cell in the cell box and press **[Zero]**. (Fig.2)
5. Take out the Cell, discard the pure water, and fill the same Cell with 1.5mL of the solution prepared using "Water Analysis Reagent Set: Oil". (Fig.3)
6. Set the Cell in the cell box again and press **[Start]**. (Fig.4)
7. The concentration will be automatically displayed.

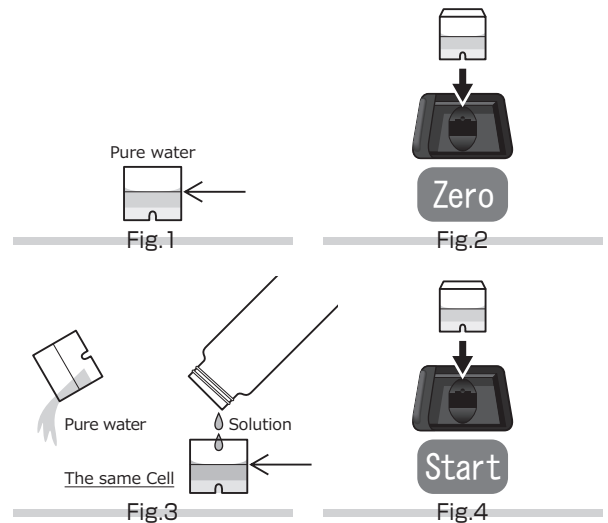

### CAUTION

In this method, the concentration of fuel oil A, Engine oil in water is measured.

For notes on the operation, refer to the usage supplied with "Water Analysis Reagent Set: Oil".

### Information on reagent

Read instruction supplied with "Water Analysis Reagent Set: Oil".

The pH of R-1 Reagent is 2 or less, and the solution is 7.

## OIL-V Vegetable Oil in Water

Color development: Transparent → White Turbidity

Method : Oil Concentration-Turbidimetry with PNIPAAm

Range : 5.0 — 60.0 mg/L(ppm) (resolution : 0.5 mg/L)

Reagent : WA-OIL-R

Reaction time : 0 min.

Additional tool : Water Analysis Reagent Set: Oil (Model: WA-OIL)

Usage : Read the instruction supplied with "Water Analysis Reagent Set: Oil".

Cell : PACKTEST Square Cup

Wavelength : 660 nm

### Procedure

1. Press **[OIL-V]**.
2. Press **[OK]** to switch to the photometry window.
3. Fill the Cell with pure water (or tap water) for 1.5 mL (up to line). (Fig.1)
4. Put the Cell in the cell box and press **[Zero]**. (Fig.2)
5. Take out the Cell, discard the pure water, and fill the same Cell with 1.5mL of the solution prepared using "Water Analysis Reagent Set: Oil". (Fig.3)
6. Set the Cell in the cell box again and press **[Start]**. (Fig.4)
7. The concentration will be automatically displayed.

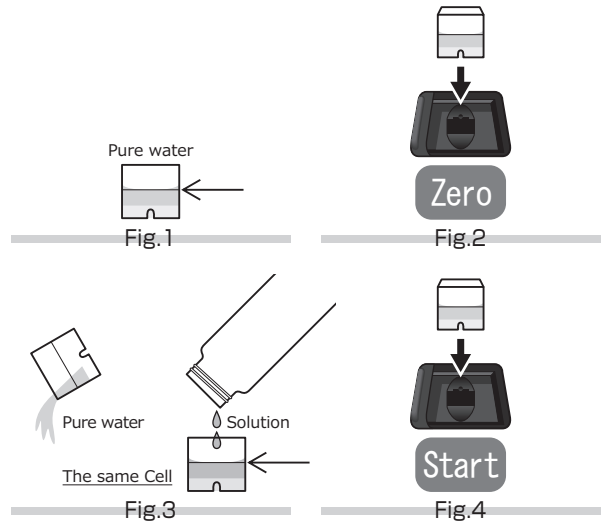

### CAUTION

In this method, the concentration of vegetable oil in water is measured.

For notes on the operation, refer to the usage supplied with "Water Analysis Reagent Set: Oil".

### Information on reagent

Read instruction supplied with "Water Analysis Reagent Set: Oil".

The pH of R-1 Reagent is 2 or less, and the solution is 7.

## OIL-S Oil in Soil

Color development: Transparent → White Turbidity

Method : Turbidimetry with PNIPAAm Extraction after Ethanol Elution

Range : Fuel oil A 400 — 5000 mg/kg (resolution : 100 mg/kg)

Reagent : SOA-OIL-RR R-1 (Dissolved in Ethanol) , R-2 (Liquid) , R-3 (Liquid)

Reaction time : 0 min.

Additional tool : Soil Screening Reagent Set: Oil (Model: SOA-OIL-NM)

Usage : Read the instruction supplied with "Soil Screening Reagent Set: Oil".

Cell : PACKTEST Square Cup

Wavelength : 660 nm

### Procedure

1. Press **[OIL-S]**.
2. Press **[OK]** to switch to the photometry window.
3. Fill the Cell with pure water (or tap water) for 1.5 mL (up to line). (Fig.1)
4. Put the Cell in the cell box and press **[Zero]**. (Fig.2)
5. Take out the Cell, discard the pure water, and fill the same Cell with 1.5 mL of the solution prepared using "Soil Screening Set: Oil". (Fig.3)
6. Set the Cell in the cell box again and press **[Start]**. (Fig.4)
7. The concentration will be automatically displayed.

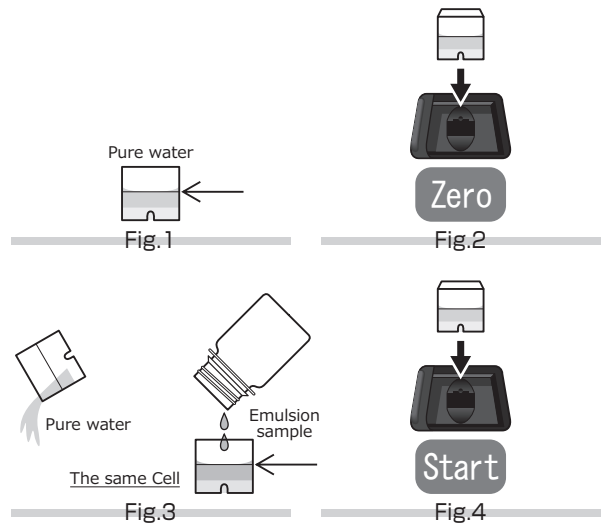

### CAUTION

1. In this method, the turbidity of the sample (solution) obtained by "Soil Screening Reagent Set: Oil" is measured and converted into a fuel oil A value. For notes on the operation, refer to the usage supplied with the "Soil Screening Reagent Set: Oil".
2. The displayed value is a fuel oil A value and the calibration curve differs depending on the oil type. If contamination by other oil than fuel oil A is anticipated, it is possible to make correction by multiplying the displayed value by any of the coefficients below.

Engine oil. . . . .	displayed value × 0.9
Fuel oil A . . . . .	displayed value × 1.0
Light oil . . . . .	displayed value × 1.0
Kerosene . . . . .	displayed value × 1.5
Gasoline . . . . .	unable to detect
3. The displayed value corresponds to the oil content (mg) per 1 kg of shape-retained soil containing water content.  
To convert to a value per dry weight, separately measure the moisture content and perform correction accordingly.

### Information on reagent

Refer to the instruction supplied with "Soil Screening Reagent Set: Oil".

The pH of the solution is about 7.



## Pb-SPK Lead (SPK)

Color development: Yellow → Orange → Red

Method : Separation and Preconcentration of lead  
by MetaSEP AnaLig<sup>®</sup> and 4-(2-Pyridylazo) resorcinol

Range : 0.03 — 0.50 mg/L(ppm)

Reagent : PACKTEST Lead (Model: SPK-Pb) K-1 (Liquid) , K-2 (Liquid) , K-3 (Liquid) , K-4 (Liquid) , Tube

Reaction time : 3 min. after drawing sample into the tube.

Usage : Read the instruction supplied with "PACKTEST Lead".

Cell : PACKTEST Square Cup

Wavelength : 519 nm

### Procedure

1. Press **[Pb-SPK]**.
2. Press **[OK]** to switch to the photometry window.
3. By following the procedures in 5 "Collection of eluent" in the usage of PACKTEST Lead, take the eluent in the Cell. (Fig.1)
4. Put the Cell in the cell box and press **[Zero]**. (Fig.2)
5. Suck the whole amount of the eluent in the Cell into the tube and press **[Start]** at the same time. (Fig.3)
6. Shake the tube in Step 5 about 30 times. If orange lumps are left in the tube, further shake the tube. (Fig.4)
7. Immediately return the solution in the tube to the Cell in a gentle manner, set it again in the cell box. (Fig.5)
8. After 3 minutes have elapsed, the concentration will be automatically displayed.

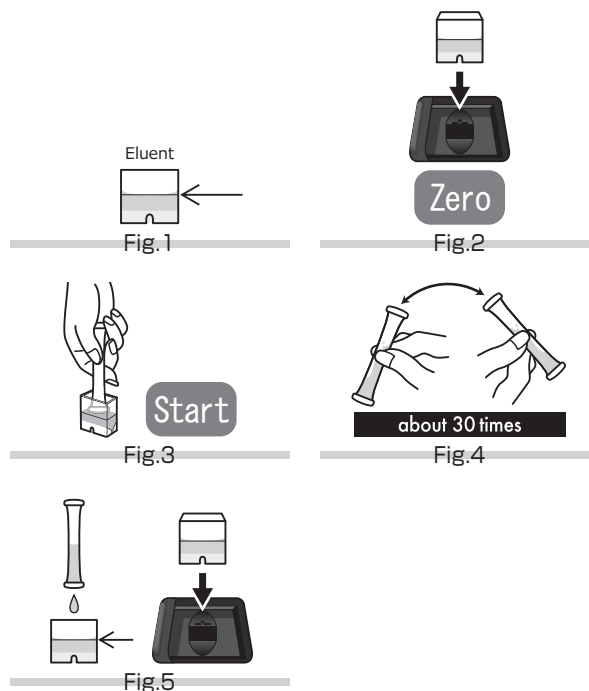

### CAUTION

1. In this method, the concentration of the eluent in the PACKTEST Lead is measured. For notes on the operation, refer to the instruction supplied with the PACKTEST Lead.
2. If the concentration of lead ions in the sample is considered high or the result is above the measurement range, dilute the sample so that the concentration falls within the measurement range, and perform steps again up to collection of eluent using the PACKTEST Lead.
3. Perform measurement with the sample temperature set to 15 to 30°C .
4. Dissolve orange lumps in the tube as much as possible. Undissolved colorless reagent will not affect the measurement.

### Influence of coexisting substance

Refer to the instruction supplied with "PACKTEST Lead".

### Information on reagent

Refer to the instruction supplied with "PACKTEST Lead".  
The pH of the solution is about 9.

## Phenol

Color development: Light yellow → Orange → Red  
Method : 4-Aminoantipyrine with enzyme  
Range : 0.20 — 5.00 mg/L(ppm)  
Reagent : WAK-PNL K-1 (Dropper) , Tube  
Reaction time : 8 min. after drawing sample into the tube.

Cell : PACKTEST Square Cup  
Wavelength : 508 nm

### Procedure

1. Press **[Phenol]**.
2. Press **[OK]** to switch to the photometry window.
3. Fill the Cell with the sample for 1.5 mL (up to line). (Fig.1)
4. Put the Cell in the cell box and press **[Zero]**. (Fig.2)
5. Add one droplet of K-1 reagent, attach the cap, and shake the Cell 2 to 3 times. (Fig.3)
6. Suck the whole amount of the sample in the Cell into the tube and press **[Start]** at the same time. (Fig.4)
7. Lightly shake the tube in Step 6 from 5 to 6 times, return the solution in the tube to the Cell in a gentle manner, set it again in the cell box. (Fig.5)
8. After 8 minutes have elapsed, the concentration will be automatically displayed.

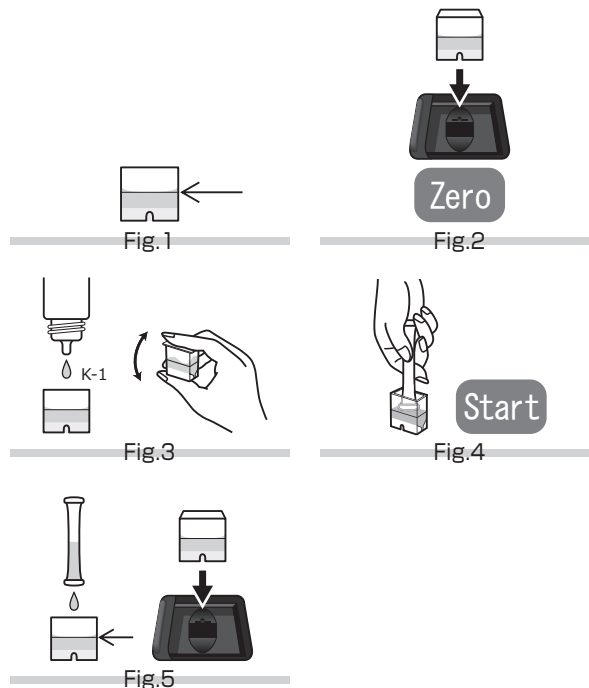

### CAUTION

1. Phenols are classified into phenol and *p*-cresol according to the JIS method, but in this method, the concentration of phenol only is measured. Note that the concentration of *p*-cresol is not measured.
2. The optimum pH during color development is 8. If the pH of the sample is not within the range from 5 to 10, neutralize the sample with dilute sulfuric acid or dilute sodium hydroxide solution, etc.
3. Perform measurement with the sample temperature set to 15 to 30°C .

### Influence of coexisting substance

The stored calibration curve has been created by using the standard solution. If the influence of other substance is considered, check the measurement value by comparing it with the official method or by standard addition method.

The right chart is the list of interference data for acceptable level by adding each of the single substances to the standard solution.

Seawater does not affect the measurement.

Oxidizing substance or reductive substance may affect the measurement.

$\leq 1000\text{mg/L.}$ : B (III), $\text{Ba}^{2+}$ , $\text{Cl}^-$ , $\text{F}^-$ , $\text{I}^-$ , $\text{K}^+$ , $\text{Mg}^{2+}$ , $\text{Na}^+$ , $\text{NO}_2^-$ , $\text{NO}_3^-$ , $\text{SO}_4^{2-}$ , $\text{Zn}^{2+}$
$\leq 500\text{mg/L.}$ : $\text{Ca}^{2+}$ , $\text{Cd}^{2+}$ , $\text{NH}_4^+$
$\leq 200\text{mg/L.}$ : As (III), $\text{PO}_4^{3-}$ , Anionic Surfactant
$\leq 100\text{mg/L.}$ : Mo (VI), $\text{SCN}^-$
$\leq 50\text{mg/L.}$ : $\text{Ag}^+$ , Cr (VI)
$\leq 20\text{mg/L.}$ : $\text{Co}^{2+}$ , $\text{Cr}^{3+}$ , $\text{Cu}^{2+}$ , $\text{Fe}^{3+}$ , $\text{Ni}^{2+}$ , Residual Chlorine
$\leq 10\text{mg/L.}$ : $\text{Mn}^{2+}$ , $\text{SO}_3^{2-}$
$\leq 5\text{mg/L.}$ : $\text{CN}^-$ , $\text{Pb}^{2+}$
$\leq 1\text{mg/L.}$ : $\text{Al}^{3+}$ , $\text{Fe}^{2+}$

### Information on reagent

Refer to the usage that comes with PACKTEST.

The pH of the solution is about 8.

## PO<sub>4</sub>-C Phosphate (High Range)

Color development: None → Light blue → Blue  
Method : Molybdenum Blue  
Range : 2.0 — 50.0 mg/L(ppm)  
Reagent : WAK-PO<sub>4</sub> (C) K-1 (Liquid) , Tube  
Reaction time : 3 min. after drawing sample into the tube.

Cell : PACKTEST Square Cup  
Wavelength : 550 nm

### Procedure

1. Press **[PO<sub>4</sub>-C]**.
2. Press **[OK]** to switch to the photometry window.
3. Fill the Cell with the sample for 0.2 mL by using the small pipette. (Fig.1)
4. Add the K-1 reagent for 1.5 mL to the sample in the Cell by using the large pipette, attach the cap, and shake the Cell 2 to 3 times. (Fig.2)
5. Remove the cap of the Cell, put the Cell in the cell box and press **[Zero]**. (Fig.3)
6. Suck the whole amount of the sample in the Cell into the tube and press **[Start]** at the same time. (Fig.4)
7. Lightly shake the tube in Step 6 from 5 to 6 times, return the solution in the tube to the Cell in a gentle manner, set it again in the cell box. (Fig.5)
8. After 3 minutes have elapsed, the concentration will be automatically displayed.

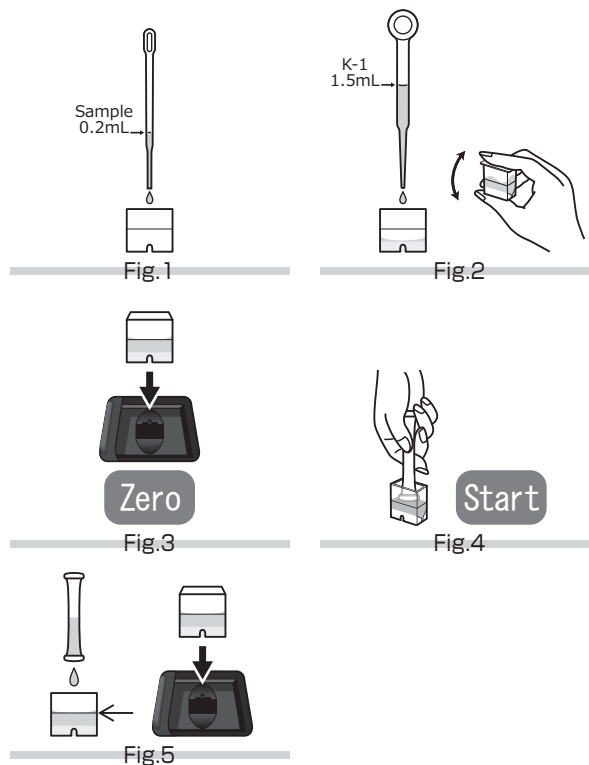

### CAUTION

1. In this method, the concentration of ionized phosphate ion(PO<sub>4</sub><sup>3-</sup>) is measured.  
It is not possible to measure the concentration of hydrolyzable phosphorus and total phosphorus. To measure the concentration of hydrolyzable phosphorus and total phosphorus, conduct pretreatment according to JIS K 0102 46.
2. Use the small pipette for sample after thoroughly cleaning it with pure water or cleaning its inside with the sample.
3. The optimum pH during color development is 1. If the pH of the sample is not within the range from 1 to 9, neutralize the sample with dilute sulfuric acid or dilute sodium hydroxide solution, etc.
4. Perform measurement with the sample and K-1 reagent temperature set to 20°C.  
If their temperature is other than 20°C, multiplying the measurement value by either of the following coefficients can implement correction.  
15°C ····· × 1.05     25°C ····· × 0.95
5. Use of a measuring pipette or the like instead of the supplied pipette enables more accurate measurement.

### Influence of coexisting substance

The stored calibration curve has been created by using the standard solution. If the influence of other substance is considered, check the measurement value by comparing it with the official method or by standard addition method.  
The right chart is the list of interference data for acceptable level by adding each of the single substances to the standard solution.

≤ 1000mg/L.: Al<sup>3+</sup>, B (III), Ca<sup>2+</sup>, Cl<sup>-</sup>, Cr<sup>3+</sup>, Fe<sup>2+</sup>, K<sup>+</sup>, Mg<sup>2+</sup>, Mn<sup>2+</sup>,  
Na<sup>+</sup>, NH<sub>4</sub><sup>+</sup>, Ni<sup>2+</sup>, NO<sub>3</sub><sup>-</sup>, SO<sub>4</sub><sup>2-</sup>, Zn<sup>2+</sup>, Phenol  
≤ 500mg/L.: NO<sub>2</sub><sup>-</sup>  
≤ 200mg/L.: F<sup>-</sup>, Fe<sup>3+</sup>, Residual Chlorine  
≤ 100mg/L.: CN<sup>-</sup>, Cr (VI), Mo (VI), Silica  
≤ 10mg/L.: Cu<sup>2+</sup>  
< 1mg/L.: As (V), Ba<sup>2+</sup>

It is not possible to measure seawater.

### Information on reagent

Refer to the usage that comes with PACKTEST.  
The pH of K-1 reagent and the solution is 2 or less.

## PO<sub>4</sub>-P-C Phosphate-Phosphorus (High Range)

Color development: None → Light blue → Blue  
Method : Molybdenum Blue  
Range : 0.7 — 15.0 mg/L(ppm)  
Reagent : WAK-PO<sub>4</sub> (C) K-1 (Liquid) , Tube  
Reaction time : 3 min. after drawing sample into the tube.

Cell : PACKTEST Square Cup  
Wavelength : 550 nm

### Procedure

1. Press **[PO<sub>4</sub>-P-C]**.
2. Press **[OK]** to switch to the photometry window.
3. Fill the Cell with the sample for 0.2 mL by using the small pipette. (Fig.1)
4. Add the K-1 reagent for 1.5 mL to the sample in the Cell by using the large pipette, attach the cap, and shake the Cell 2 to 3 times. (Fig.2)
5. Remove the cap of the Cell, put the Cell in the cell box and press **[Zero]**. (Fig.3)
6. Suck the whole amount of the sample in the Cell into the tube and press **[Start]** at the same time. (Fig.4)
7. Lightly shake the tube in Step 6 from 5 to 6 times, return the solution in the tube to the Cell in a gentle manner, set it again in the cell box. (Fig.5)
8. After 3 minutes have elapsed, the concentration will be automatically displayed.

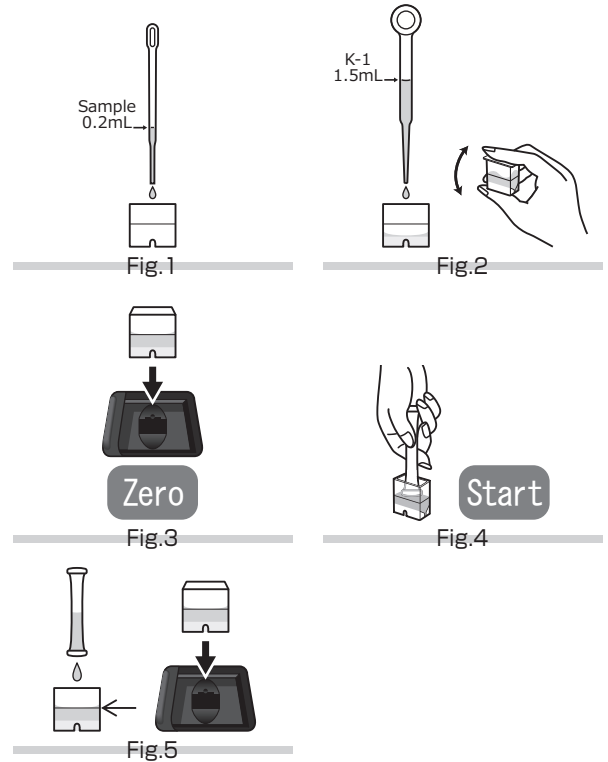

### CAUTION

1. In this method, the concentration of ionized phosphate ion(PO<sub>4</sub><sup>3-</sup>) is measured.  
It is not possible to measure the concentration of hydrolyzable phosphorus and total phosphorus. To measure the concentration of hydrolyzable phosphorus and total phosphorus, conduct pretreatment according to JIS K 0102 46.
2. Use the small pipette for sample after thoroughly cleaning it with pure water or cleaning its inside with the sample.
3. The optimum pH during color development is 1. If the pH of the sample is not within the range from 1 to 9, neutralize the sample with dilute sulfuric acid or dilute sodium hydroxide solution, etc.
4. Perform measurement with the sample and K-1 reagent temperature set to 20°C.  
If their temperature is other than 20°C, multiplying the measurement value by either of the following coefficients can implement correction.  
15°C ····· × 1.05      25°C ····· × 0.95
5. Use of a measuring pipette or the like instead of the supplied pipette enables more accurate measurement.

### Influence of coexisting substance

The stored calibration curve has been created by using the standard solution. If the influence of other substance is considered, check the measurement value by comparing it with the official method or by standard addition method.  
The right chart is the list of interference data for acceptable level by adding each of the single substances to the standard solution.

≤ 1000mg/L.: Al<sup>3+</sup>, B (III), Ca<sup>2+</sup>, Cl<sup>-</sup>, Cr<sup>3+</sup>, Fe<sup>2+</sup>, K<sup>+</sup>, Mg<sup>2+</sup>, Mn<sup>2+</sup>,  
Na<sup>+</sup>, NH<sub>4</sub><sup>+</sup>, Ni<sup>2+</sup>, NO<sub>3</sub><sup>-</sup>, SO<sub>4</sub><sup>2-</sup>, Zn<sup>2+</sup>, Phenol  
≤ 500mg/L.: NO<sub>2</sub><sup>-</sup>  
≤ 200mg/L.: F<sup>-</sup>, Fe<sup>3+</sup>, Residual Chlorine  
≤ 100mg/L.: CN<sup>-</sup>, Cr (VI), Mo (VI), Silica  
≤ 10mg/L.: Cu<sup>2+</sup>  
< 1mg/L.: As (V), Ba<sup>2+</sup>

It is not possible to measure seawater.

### Information on reagent

Refer to the usage that comes with PACKTEST.  
The pH of K-1 reagent and the solution is 2 or less.

## PO<sub>4</sub> Phosphate

Color development: None → Light blue → Blue  
Method : Molybdenum Blue  
Range : 0.10 — 5.00 mg/L(ppm)  
Reagent : WAK-PO<sub>4</sub> K-1 (Dropper) , Tube  
Reaction time : 3 min. after drawing sample into the tube.

Cell : PACKTEST Square Cup  
Wavelength : 650 nm, 580 nm

### Procedure

1. Press **[PO<sub>4</sub>]**.
2. Press **[OK]** to switch to the photometry window
3. Fill the Cell with the sample for 1.5 mL (up to line). (Fig.1)
4. Put the Cell in the cell box and press **[Zero]**. (Fig.2)
5. Add four droplets of K-1 reagent, attach the cap, and shake the Cell 2 to 3 times. (Fig.3)
6. Suck the whole amount of the sample in the Cell into the tube and press **[Start]** at the same time. (Fig.4)
7. Lightly shake the tube in Step 6 from 5 to 6 times, return the solution in the tube to the Cell in a gentle manner, set it again in the cell box. (Fig.5)
8. After 3 minutes have elapsed, the concentration will be automatically displayed.

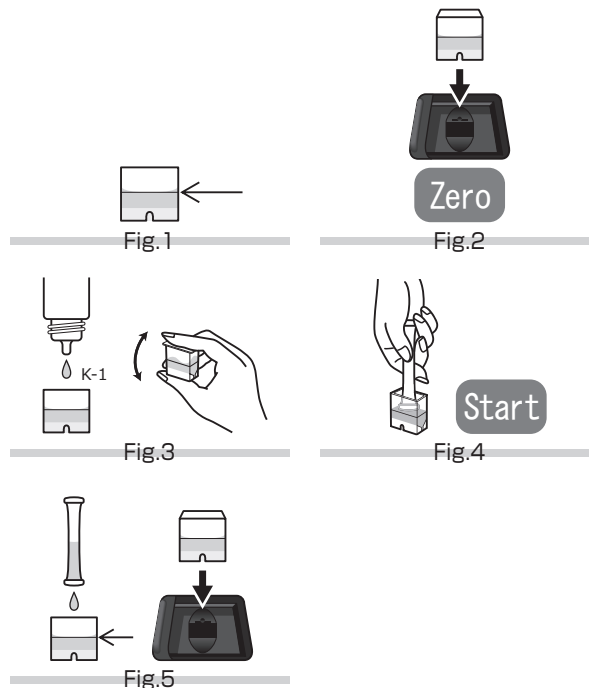

### CAUTION

1. In this method, the concentration of ionized phosphoric acid (PO<sub>4</sub><sup>3-</sup>) in the sample is measured.  
It is not possible to measure the concentration of hydrolyzable phosphorus and total phosphorus. To measure the concentration of hydrolyzable phosphorus and total phosphorus, conduct pretreatment according to JIS K 0102 46 or refer to "TP Total Phosphorus".
2. The optimum pH during color development is 1. If the pH of the sample is not within the range from 1 to 9, neutralize the sample with dilute sulfuric acid or dilute sodium hydroxide solution, etc.
3. Perform measurement with the sample temperature set to 20°C.  
If the sample temperature is other than 20 °C, multiplying the measurement value by either of the following coefficients can implement correction.  
15°C ····· ×1.05      25°C ····· ×0.95

### Influence of coexisting substance

The stored calibration curve has been created by using the standard solution. If the influence of other substance is considered, check the measurement value by comparing it with the official method or by standard addition method.  
The right chart is the list of interference data for acceptable level by adding each of the single substances to the standard solution.

≤ 1000mg/L.: B (III), Cl<sup>-</sup>, CN<sup>-</sup>, K<sup>+</sup>, Na<sup>+</sup>, NH<sub>4</sub><sup>+</sup>, NO<sub>3</sub><sup>-</sup>, SO<sub>4</sub><sup>2-</sup>, Zn<sup>2+</sup>  
≤ 800mg/L.: Al<sup>3+</sup>, Mn<sup>2+</sup>  
≤ 500mg/L.: Mg<sup>2+</sup>, NO<sub>2</sub><sup>-</sup>  
≤ 100mg/L.: Cr<sup>3+</sup>, Fe<sup>2+</sup>, Fe<sup>3+</sup>, Ni<sup>2+</sup>, Silica, Phenol  
≤ 50mg/L.: Co<sup>2+</sup>, Cu<sup>2+</sup>, F<sup>-</sup>, I<sup>-</sup>, Residual Chlorine  
≤ 20mg/L.: Ca<sup>2+</sup>, Cr (VI), Mo (VI)  
< 1mg/L.: As (V), Ba<sup>2+</sup>

It is not possible to measure seawater.

### Information on reagent

Refer to the usage that comes with PACKTEST.  
The pH of K-1 reagent and the solution is 2 or less.

## PO<sub>4</sub>-P Phosphate-Phosphorus

Color development: None → Light blue → Blue  
Method : Molybdenum Blue  
Range : 0.03 — 1.50 mg/L(ppm)  
Reagent : WAK-PO<sub>4</sub> K-1 (Dropper) , Tube  
Reaction time : 3 min. after drawing sample into the tube.

Cell : PACKTEST Square Cup  
Wavelength : 650 nm, 580 nm

### Procedure

1. Press **[PO<sub>4</sub>-P]**.
2. Press **[OK]** to switch to the photometry window
3. Fill the Cell with the sample for 1.5 mL (up to line). (Fig.1)
4. Put the Cell in the cell box and press **[Zero]**. (Fig.2)
5. Add four droplets of K-1 reagent, attach the cap, and shake the Cell 2 to 3 times. (Fig.3)
6. Suck the whole amount of the sample in the Cell into the tube and press **[Start]** at the same time. (Fig.4)
7. Lightly shake the tube in Step 6 from 5 to 6 times, return the solution in the tube to the Cell in a gentle manner, set it again in the cell box. (Fig.5)
8. After 3 minutes have elapsed, the concentration will be automatically displayed.

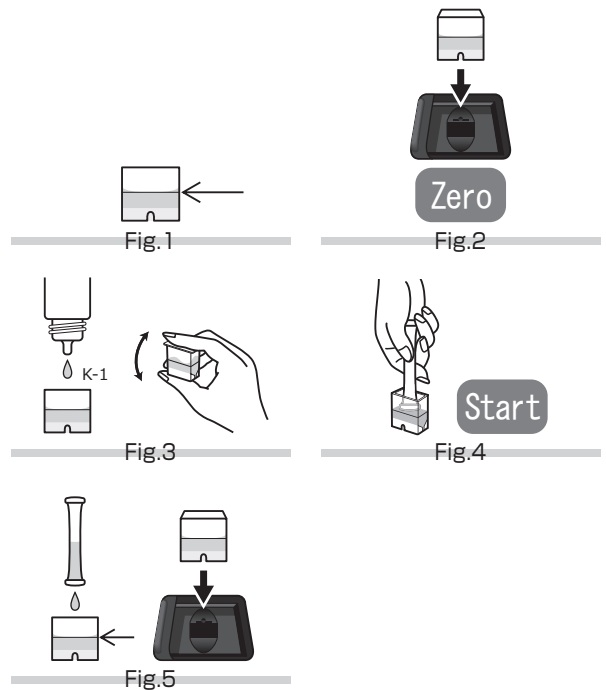

### CAUTION

1. In this method, the concentration of ionized phosphoric acid (PO<sub>4</sub><sup>3-</sup>) in the sample is measured.  
It is not possible to measure the concentration of hydrolyzable phosphorus and total phosphorus. To measure the concentration of hydrolyzable phosphorus and total phosphorus, conduct pretreatment according to JIS K 0102 46 or refer to "TP Total Phosphorus".
2. The optimum pH during color development is 1. If the pH of the sample is not within the range from 1 to 9, neutralize the sample with dilute sulfuric acid or dilute sodium hydroxide solution, etc.
3. Perform measurement with the sample temperature set to 20°C.  
If the sample temperature is other than 20 °C, multiplying the measurement value by either of the following coefficients can implement correction.  
15°C ····· ×1.05      25°C ····· ×0.95

### Influence of coexisting substance

The stored calibration curve has been created by using the standard solution. If the influence of other substance is considered, check the measurement value by comparing it with the official method or by standard addition method.  
The right chart is the list of interference data for acceptable level by adding each of the single substances to the standard solution.

≤ 1000mg/L.: B (III), Cl<sup>-</sup>, CN<sup>-</sup>, K<sup>+</sup>, Na<sup>+</sup>, NH<sub>4</sub><sup>+</sup>, NO<sub>3</sub><sup>-</sup>, SO<sub>4</sub><sup>2-</sup>, Zn<sup>2+</sup>  
≤ 800mg/L.: Al<sup>3+</sup>, Mn<sup>2+</sup>  
≤ 500mg/L.: Mg<sup>2+</sup>, NO<sub>2</sub><sup>-</sup>  
≤ 100mg/L.: Cr<sup>3+</sup>, Fe<sup>2+</sup>, Fe<sup>3+</sup>, Ni<sup>2+</sup>, Silica, Phenol  
≤ 50mg/L.: Co<sup>2+</sup>, Cu<sup>2+</sup>, F<sup>-</sup>, I<sup>-</sup>, Residual Chlorine  
≤ 20mg/L.: Ca<sup>2+</sup>, Cr (VI), Mo (VI)  
< 1mg/L.: As (V), Ba<sup>2+</sup>

It is not possible to measure seawater.

### Information on reagent

Refer to the usage that comes with PACKTEST.  
The pH of K-1 reagent and the solution is 2 or less.

## PO<sub>4</sub>-D Phosphate (Low Range)

Color development: None → Light purple → Purple  
Method : 4-Aminoantipyrine with enzyme  
Range : 0.10 — 3.00 mg/L (ppm)  
Reagent : WAK-PO<sub>4</sub> (D) Tube  
Reaction time : 5 min. after drawing sample into the tube.

Cell : PACKTEST Square Cup  
Wavelength : 540 nm, 570 nm

### Procedure

1. Press **[PO<sub>4</sub>-D]**.
2. Press **[OK]** to switch to the photometry window.
3. Fill the Cell with the sample for 1.5 mL (up to line). (Fig.1)
4. Put the Cell in the cell box and press **[Zero]**. (Fig.2)
5. Suck the whole amount of the sample in the Cell into the tube and press **[Start]** at the same time. (Fig.3)
6. Lightly shake the tube in Step 5 from 5 to 6 times, return the solution in the tube to the Cell in a gentle manner, set it again in the cell box. (Fig.4)
7. After 5 minutes have elapsed, the concentration will be automatically displayed.

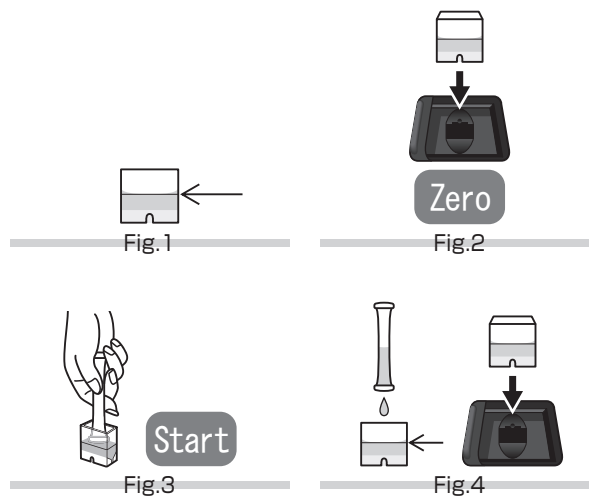

### CAUTION

1. In this method, the concentration of ionized phosphate ion(PO<sub>4</sub><sup>3-</sup>) is measured.  
It is not possible to measure the concentration of hydrolyzable phosphorus and total phosphorus. To measure the concentration of hydrolyzable phosphorus and total phosphorus, conduct pretreatment according to JIS K 0102 46.
2. The optimum pH during color development is 7. If the pH of the sample is not within the range from 6 to 9, neutralize the sample with dilute sulfuric acid or dilute sodium hydroxide solution, etc.
3. Perform measurement with the sample temperature set to 15 to 30°C .

### Influence of coexisting substance

The stored calibration curve has been created by using the standard solution. If the influence of other substance is considered, check the measurement value by comparing it with the official method or by standard addition method.

The right chart is the list of interference data for acceptable level by adding each of the single substances to the standard solution.

It is not possible to measure seawater.

Oxidizing substance such as hydrogen peroxide and residual chlorine may cause a positive measurement error.

Reductive substance may cause a negative measurement error.

≤ 1000mg/L.: Ba<sup>2+</sup>, Ca<sup>2+</sup>, Cl<sup>-</sup>, F<sup>-</sup>, I<sup>-</sup>, K<sup>+</sup>, Na<sup>+</sup>, NH<sub>4</sub><sup>+</sup>, NO<sub>2</sub><sup>-</sup>, NO<sub>3</sub><sup>-</sup>  
≤ 500mg/L.: B (III)  
≤ 250mg/L.: Phenol  
≤ 100mg/L.: Zn<sup>2+</sup>  
≤ 50mg/L.: Cu<sup>2+</sup>, Ni<sup>2+</sup>, SO<sub>4</sub><sup>2-</sup>  
≤ 20mg/L.: Mg<sup>2+</sup>  
≤ 10mg/L.: Al<sup>3+</sup>, Cr<sup>3+</sup>, Cr (VI)  
≤ 5mg/L.: Fe<sup>3+</sup>, Mn<sup>2+</sup>  
≤ 1mg/L.: CN<sup>-</sup>  
< 1mg/L.: Fe<sup>2+</sup>, Residual Chlorine

### Information on reagent

Refer to the usage that comes with PACKTEST.

The pH of the solution is about 7.

## PO<sub>4</sub>-P-D Phosphate-Phosphorus (Low Range)

Color development: None → Light purple → Purple  
Method : 4-Aminoantipyrine with enzyme  
Range : 0.03 — 1.00 mg/L(ppm)  
Reagent : WAK-PO<sub>4</sub> (D) Tube  
Reaction time : 5 min. after drawing sample into the tube.

Cell : PACKTEST Square Cup  
Wavelength : 540 nm, 570 nm

### Procedure

1. Press **[PO<sub>4</sub>-P-D]**.
2. Press **[OK]** to switch to the photometry window.
3. Fill the Cell with the sample for 1.5 mL (up to line). (Fig.1)
4. Put the Cell in the cell box and press **[Zero]**. (Fig.2)
5. Suck the whole amount of the sample in the Cell into the tube and press **[Start]** at the same time. (Fig.3)
6. Lightly shake the tube in Step 5 from 5 to 6 times, return the solution in the tube to the Cell in a gentle manner, set it again in the cell box. (Fig.4)
7. After 5 minutes have elapsed, the concentration will be automatically displayed.

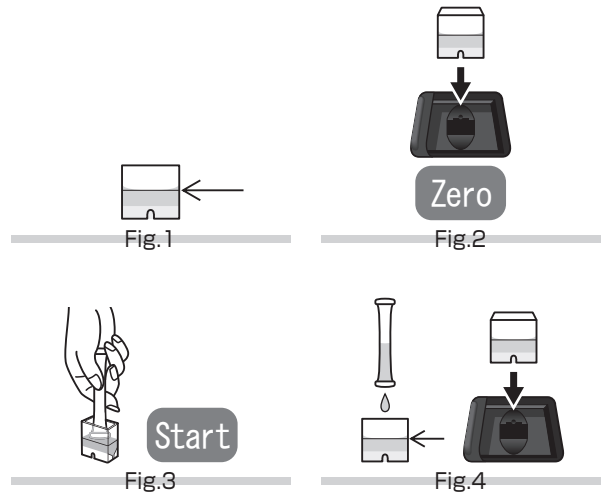

### CAUTION

1. In this method, the concentration of ionized phosphate ion(PO<sub>4</sub><sup>3-</sup>) is measured.  
It is not possible to measure the concentration of hydrolyzable phosphorus and total phosphorus. To measure the concentration of hydrolyzable phosphorus and total phosphorus, conduct pretreatment according to JIS K 0102 46.
2. The optimum pH during color development is 7. If the pH of the sample is not within the range from 6 to 9, neutralize the sample with dilute sulfuric acid or dilute sodium hydroxide solution, etc.
3. Perform measurement with the sample temperature set to 15 to 30°C .

### Influence of coexisting substance

The stored calibration curve has been created by using the standard solution. If the influence of other substance is considered, check the measurement value by comparing it with the official method or by standard addition method.

The right chart is the list of interference data for acceptable level by adding each of the single substances to the standard solution.

It is not possible to measure seawater.

Oxidizing substance such as hydrogen peroxide and residual chlorine may cause a positive measurement error.

Reductive substance may cause a negative measurement error.

≤ 1000mg/L.: Ba <sup>2+</sup> , Ca <sup>2+</sup> , Cl <sup>-</sup> , F <sup>-</sup> , I <sup>-</sup> , K <sup>+</sup> , Na <sup>+</sup> , NH <sub>4</sub> <sup>+</sup> , NO <sub>2</sub> <sup>-</sup> , NO <sub>3</sub> <sup>-</sup>
≤ 500mg/L.: B (III)
≤ 250mg/L.: Phenol
≤ 100mg/L.: Zn <sup>2+</sup>
≤ 50mg/L.: Cu <sup>2+</sup> , Ni <sup>2+</sup> , SO <sub>4</sub> <sup>2-</sup>
≤ 20mg/L.: Mg <sup>2+</sup>
≤ 10mg/L.: Al <sup>3+</sup> , Cr <sup>3+</sup> , Cr (VI)
≤ 5mg/L.: Fe <sup>3+</sup> , Mn <sup>2+</sup>
≤ 1mg/L.: CN <sup>-</sup>
< 1mg/L.: Fe <sup>2+</sup> , Residual Chlorine

### Information on reagent

Refer to the usage that comes with PACKTEST.

The pH of the solution is about 7.



## S Sulfide (Hydrogen Sulfide)

Color development: None → Light blue → Blue  
Method : Methylene blue Method  
Range : 0.05 — 0.80 mg/L(ppm)  
Reagent : WAK-S K-1 (Dropper) , Tube  
Reaction time : 3 min. after drawing sample into the tube.

Cell : PACKTEST Square Cup  
Wavelength : 670 nm, 620 nm

### Procedure

1. Press [S].
2. Press [OK] to switch to the photometry window.
3. Fill the Cell with the sample for 1.5 mL (up to line). (Fig.1)
4. Put the Cell in the cell box and press [Zero]. (Fig.2)
5. Add two droplets of K-1 reagent. (Fig.3)
6. Immediately suck the whole amount of the sample in the Cell into the tube and press [Start] at the same time. (Fig.4)
7. Lightly shake the tube in Step 6 from 5 to 6 times, return the solution in the tube to the Cell in a gentle manner, set it again in the cell box. (Fig.5)
8. After 3 minutes have elapsed, the concentration will be automatically displayed.

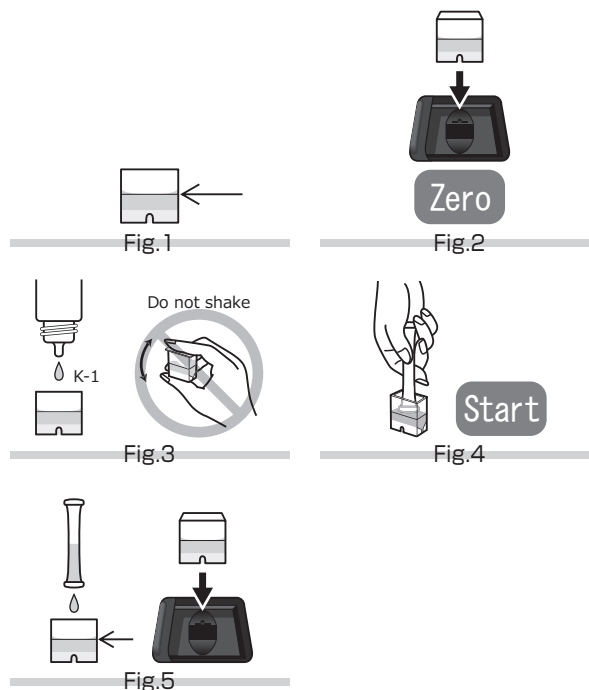

### CAUTION

1. In this method, the concentration of sulfur in the hydrogen sulfide ( $H_2S$ ), ionized hydrogen sulfide ( $HS^-$ ) and sulfide ion ( $S^{2-}$ ) states is measured. It is not possible to measure the concentration of sulfuric acid and sulfurous acid.
2. In the case where the sulfide existing in the sample is considered sulfide ions ( $S^{2-}$ ) only, the obtained result can be converted into the concentration of hydrogen sulfide by multiplying it by 1.06.
3. The optimum pH during color development is 2. If the pH of the sample is not within the range from 2 to 9, neutralize the sample with dilute sulfuric acid or dilute sodium hydroxide solution, etc.
4. Perform measurement with the sample temperature set to 15 to 30°C.

### Influence of coexisting substance

The stored calibration curve has been created by using the standard solution. If the influence of other substance is considered, check the measurement value by comparing it with the official method or by standard addition method.

The right chart is the list of interference data for acceptable level by adding each of the single substances to the standard solution.

Seawater does not affect the measurement.

Oxidizing substance or reductive substance may affect the measurement.

If metallic ions are mixed with sulfide ions, metallic sulfide is produced and it cannot be detected as sulfide ions any longer. In this case, perform separation of metallic sulfide by referring to the JIS method or others.

#### Except for Heavy metal ions:

- ≤ 100mg/L.: B (III),  $Ca^{2+}$ ,  $Cl^-$ ,  $F^-$ ,  $K^+$ ,  $Mg^{2+}$ ,  $Na^+$ ,  $NH_4^+$ ,  $NO_3^-$ ,  $PO_4^{3-}$ ,  $SO_4^{2-}$ , Phenol, Anionic Surfactant
- ≤ 10mg/L.:  $I^-$
- ≤ 1mg/L.:  $NO_2^-$ ,  $SO_3^{2-}$
- < 1mg/L.: Residual Chlorine

#### Heavy metal ions:

- ≤ 10mg/L.:  $Al^{3+}$ ,  $Ba^{2+}$ ,  $CN^-$ ,  $Co^{2+}$ ,  $Cr^{3+}$ ,  $Fe^{2+}$ ,  $Fe^{3+}$ ,  $Ni^{2+}$ ,  $Zn^{2+}$
- ≤ 5mg/L.:  $Mn^{2+}$ , Mo (VI)
- ≤ 1mg/L.: Cr (VI)
- < 1mg/L.:  $Cu^{2+}$

### Information on reagent

Refer to the usage that comes with PACKTEST.

The pH of K-1 reagent and the solution is 2 or less.

## SiO<sub>2</sub> Silica

Color development: None → Light blue → Blue

Method : Molybdenum Blue

Range : 3.0 — 60.0 mg/L(ppm)

Reagent : WAK-SiO<sub>2</sub> Distilled water, K-1 (Dropper) , K-2 (Dropper) , Tube

Reaction time : 5 min. after drawing sample into the tube.

Cell : PACKTEST Square Cup

Wavelength : 650 nm, 560 nm

### Procedure

1. Press **[SiO<sub>2</sub>]**.
2. Press **[OK]** to switch to the photometry window.
3. Fill the Cell with the sample for 0.2 mL by using the small pipette. (Fig.1)
4. Add the Water for Dilution for 1.5 mL to the sample in the Cell by using the large pipette, attach the cap, and shake the Cell 2 to 3 times. (Fig.2)
5. Remove the cap of the Cell, put the Cell in the cell box and press **[Zero]**. (Fig.3)
6. Add two droplets of K-1 reagent, attach the cap, shake the Cell 2 to 3 times, and leave for 3 minutes. (Fig.4)
7. Add one droplet of K-2 reagent, attach the cap, shake the Cell 2 to 3 times, and leave for 30 seconds. (Fig.5)
8. Suck the whole amount of the sample in the Cell into the tube and press **[Start]** at the same time. (Fig.6)
9. Lightly shake the tube in Step 8 from 5 to 6 times, return the solution in the tube to the Cell in a gentle manner, set it again in the cell box. (Fig.7)
10. After 5 minutes have elapsed, the concentration will be automatically displayed.

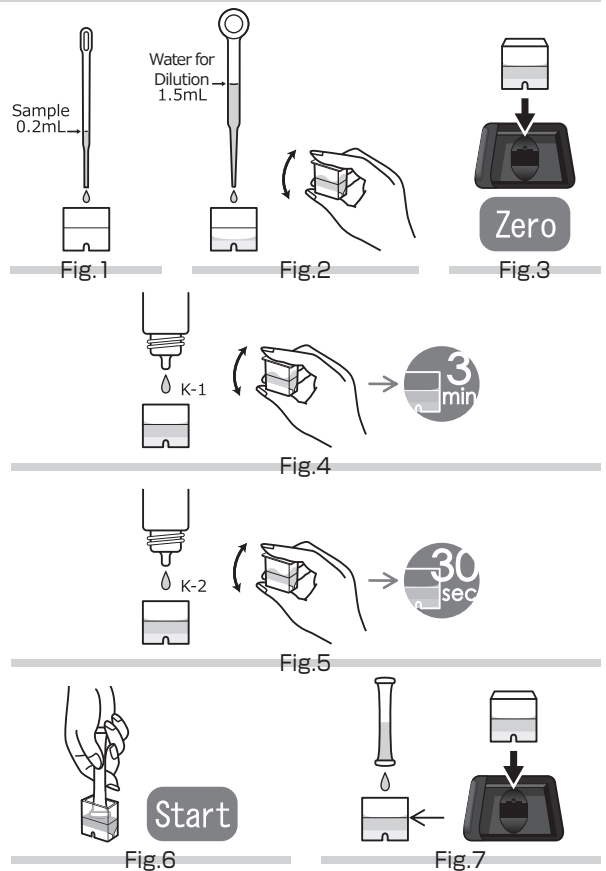

### CAUTION

1. While silica is classified into ionized silica, dissolved and colloidal silica and total silica and each of them is displayed as silicon dioxide (SiO<sub>2</sub>), in this method, the concentration of ionized silica (SiO<sub>3</sub><sup>2-</sup>) is measured. To measure the dissolved and colloidal silica and total silica, perform measurement after pretreatment of the respective measurement targets according to JIS K 0101 44.2 or 44.3.
2. Use the small pipette for sample after thoroughly cleaning it with pure water or cleaning its inside with the sample.
3. The optimum pH during color development is 2. If the pH of the sample is not within the range from 2 to 9, neutralize the sample with dilute sulfuric acid or dilute sodium hydroxide solution, etc.
4. Perform measurement with the temperatures of the sample and dilution water set to 15 to 30°C.
5. Use of a measuring pipette or the like instead of the supplied pipette enables more accurate measurement.

### Influence of coexisting substance

The stored calibration curve has been created by using the standard solution. If the influence of other substance is considered, check the measurement value by comparing it with the official method or by standard addition method.

The right chart is the list of interference data for acceptable level by adding each of the single substances to the standard solution.

Seawater does not affect the measurement.

Oxidizing substance or reductive substance may affect the measurement.

Even a tiny amount of hydrogen sulfide may obstruct the measurement. If hydrogen sulfide is considered to coexist, acidify and boil the sample to remove hydrogen sulfide before performing measurement.

≤ 5000mg/L.: Al<sup>3+</sup>, B (III), Ca<sup>2+</sup>, Cl<sup>-</sup>, CN<sup>-</sup>, Co<sup>2+</sup>, Fe<sup>2+</sup>, I<sup>-</sup>, K<sup>+</sup>, Mg<sup>2+</sup>, Mn<sup>2+</sup>, Mo (VI), Na<sup>+</sup>, NH<sub>4</sub><sup>+</sup>, Ni<sup>2+</sup>, NO<sub>3</sub><sup>-</sup>, SO<sub>4</sub><sup>2-</sup>, Zn<sup>2+</sup>, Anionic Surfactant, Residual Chlorine, Phenol, Formaldehyde  
≤ 1000mg/L.: Cr (VI), Cu<sup>2+</sup>, F<sup>-</sup>, Fe<sup>3+</sup>, NO<sub>2</sub><sup>-</sup>  
≤ 500mg/L.: PO<sub>4</sub><sup>3-</sup>  
≤ 100mg/L.: Ba<sup>2+</sup>, Cr<sup>3+</sup>  
≤ 50mg/L.: V (V)

### Information on reagent

Refer to the usage that comes with PACKTEST.

The pH of K-1 reagent, K-2 reagent, and the solution is 2 or less.

## SiO<sub>2</sub>-D Silica (Low Range)

Color development: None → Light blue → Blue  
Method : Molybdenum Blue  
Range : 0.30 — 7.00 mg/L(ppm)  
Reagent : WAK-SiO<sub>2</sub> (D) K-1 (Dropper) , K-2 (Dropper) , Tube  
Reaction time : 5 min. after drawing sample into the tube.

Cell : PACKTEST Square Cup  
Wavelength : 650 nm, 560 nm

### Procedure

1. Press **[SiO<sub>2</sub>-D]**.
2. Press **[OK]** to switch to the photometry window.
3. Fill the Cell with the sample for 1.5 mL (up to line). (Fig.1)
4. Put the Cell in the cell box and press **[Zero]**. (Fig.2)
5. Add two droplets of K-1 reagent, attach the cap, shake the Cell 2 to 3 times, and leave for 3 minutes. (Fig.3)
6. Add one droplet of K-2 reagent, attach the cap, shake the Cell 2 to 3 times, and leave for 30 seconds. (Fig.4)
7. Suck the whole amount of the sample in the Cell into the tube and press **[Start]** at the same time. (Fig.5)
8. Lightly shake the tube in Step 7 from 5 to 6 times, return the solution in the tube to the Cell in a gentle manner, set it again in the cell box. (Fig.6)
9. After 5 minutes have elapsed, the concentration will be automatically displayed.

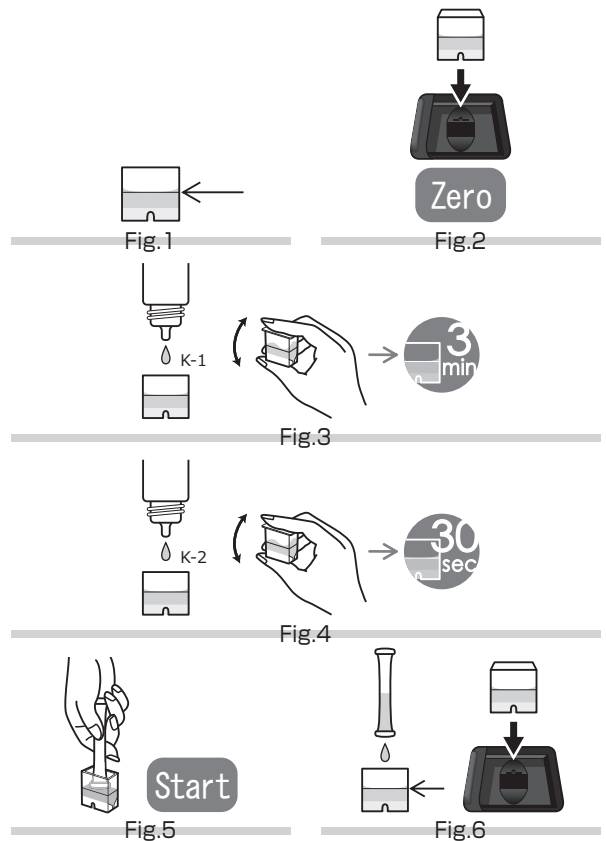

### CAUTION

1. While silica is classified into ionized silica, dissolved and colloidal silica and total silica and each of them is displayed as silicon dioxide (SiO<sub>2</sub>), in this method, the concentration of ionized silica (SiO<sub>3</sub><sup>2-</sup>) is measured. To measure the dissolved and colloidal silica and total silica, perform measurement after pretreatment of the respective measurement targets according to JIS K 0101 44.2 or 44.3.
2. The optimum pH during color development is 2. If the pH of the sample is not within the range from 2 to 9, neutralize the sample with dilute sulfuric acid or dilute sodium hydroxide solution, etc.
3. Perform measurement with the temperatures of the sample and dilution water set to 15 to 30°C .

### Influence of coexisting substance

The stored calibration curve has been created by using the standard solution. If the influence of other substance is considered, check the measurement value by comparing it with the official method or by standard addition method.

The right chart is the list of interference data for acceptable level by adding each of the single substances to the standard solution.

Seawater does not affect the measurement.

Oxidizing substance or reductive substance may affect the measurement.

Even a tiny amount of hydrogen sulfide may obstruct the measurement. If hydrogen sulfide is considered to coexist, acidify and boil the sample to remove hydrogen sulfide before performing measurement.

≤ 1000mg/L.: Al <sup>3+</sup> , B (III), Ca <sup>2+</sup> , Cl <sup>-</sup> , CN <sup>-</sup> , Co <sup>2+</sup> , Fe <sup>2+</sup> , I <sup>-</sup> , K <sup>+</sup> , Mg <sup>2+</sup> , Mn <sup>2+</sup> , Mo (VI), Na <sup>+</sup> , NH <sub>4</sub> <sup>+</sup> , Ni <sup>2+</sup> , NO <sub>3</sub> <sup>-</sup> , SO <sub>4</sub> <sup>2-</sup> , Zn <sup>2+</sup> , Anionic Surfactant, Residual Chlorine, Phenol, Formaldehyde
≤ 500mg/L.: NO <sub>2</sub> <sup>-</sup>
≤ 200mg/L.: Cr (VI)
≤ 100mg/L.: Cu <sup>2+</sup> , F <sup>-</sup> , Fe <sup>3+</sup>
≤ 50mg/L.: PO <sub>4</sub> <sup>3-</sup>
≤ 10mg/L.: Ba <sup>2+</sup> , Cr <sup>3+</sup> , V (V)

### Information on reagent

Refer to the usage that comes with PACKTEST.

The pH of K-1 reagent, K-2 reagent, and the solution is 2 or less.

## SO<sub>4</sub> Sulfate

Color development: Transparent → White Turbidity  
Method : Barium sulfate turbidimetry  
Range : 5 — 100 mg/L(ppm)  
Reagent : DPR—SO<sub>4</sub> R—A (Dropper) , R-1 (Dropper) , R-2 (Dropper)  
Reaction time : 3 min. after R-2 reagent is added.

Cell : PACKTEST Square Cup  
Wavelength : 615 nm

### Procedure

1. Press **[SO<sub>4</sub>]**.
2. Press **[OK]** to switch to the photometry window.
3. Fill the Cell with the sample for 1.5 mL (up to line). (Fig.1)
4. Add one droplet of the R-A reagent, attach the cap, and shake the Cell 2 to 3 times. (Fig.2)
5. Add one droplet of the R-1 reagent after shaking it intensely, attach the cap, and shake the Cell 2 to 3 times. (Fig.3)
6. Remove the cap of the Cell, put the Cell in the cell box and press **[Zero]**. (Fig.4)
7. Add one droplet of the R-2 reagent, attach the cap, shake the Cell 30 times or more in 10 seconds, and press **[Start]**. (Fig.5)
8. Remove the cap of the Cell, set the Cell in the cell box again. (Fig.6)
9. After 3 minutes have elapsed, the concentration will be automatically displayed.

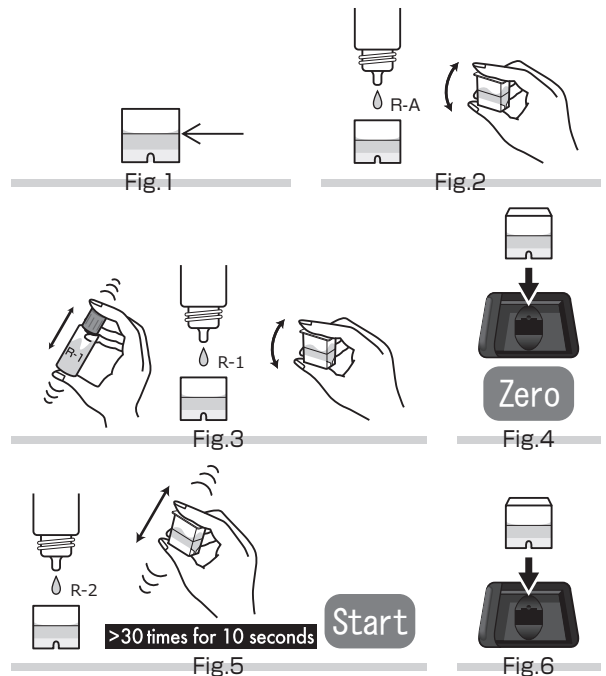

### CAUTION

1. In this method, the concentration of ionized sulfuric acid (SO<sub>4</sub><sup>2-</sup>) is measured.
2. The optimum pH during color development is about 2. If the pH of the sample is not within the range from 2 to 9, neutralize the sample with dilute hydrochloric acid or dilute sodium hydroxide solution, etc. (Do not use sulfuric acid.)
3. Perform measurement with the sample temperature set to 20 to 30°C.
4. Depending on the operation method, the results vary. In Step 7 of "Procedure", shake the Cell in a constant manner. If the Cell is shaken gently, the measurement value tends to be low. If the Cell is shaken intensely, the measurement value tends to be high.
5. To set the Cell in the cell box, remove the cap. Wipe off water droplets before setting the Cell in the cell box.
6. As turbid substances attach to the Cell after measurement, thoroughly clean the Cell.

### Influence of coexisting substance

The stored calibration curve has been created by using the standard solution. If the influence of other substance is considered, check the measurement value by comparing it with the official method or by standard addition method. The right chart is the list of interference data for acceptable level by adding each of the single substances to the standard solution.

It is possible to measure seawater, but as it has a high concentration of sulfate ions, dilution is necessary. (Approximately 100 times in the case of artificial seawater)

Substances such as sulfite ions and thiosulfuric acid ions turn into sulfate ions and are measured depending on their oxidation state.

If anions that cause production of insoluble barium salt are contained under the acid condition, measurement is not possible.

#### Except for Heavy metal ions:

- ≤ 1000mg/L.: B (III) , Ca<sup>2+</sup> , Cl<sup>-</sup> , F<sup>-</sup> , K<sup>+</sup> , Na<sup>+</sup> , NH<sub>4</sub><sup>+</sup> , NO<sub>2</sub><sup>-</sup> , NO<sub>3</sub><sup>-</sup> , Phenol
- ≤ 500mg/L.: PO<sub>4</sub><sup>3-</sup>
- ≤ 200mg/L.: Residual Chlorine
- < 1mg/L.: Anionic Surfactant

#### Heavy metal ions:

- ≤ 200mg/L.: Fe<sup>3+</sup>
- ≤ 100mg/L.: Cr (VI)
- ≤ 20mg/L.: Al<sup>3+</sup>

### Information on reagent

Refer to the usage supplied with "DPR-SO<sub>4</sub>".

The pH of the R-1 reagent and the solution is about 2 or less.

## TH Total Hardness

Color development: Light purple → Purple  
Method : Phthalein Complexone  
Range : 10 — 150 mg/L(ppm)  
Reagent : WAK-TH Tube  
Reaction time : 1 min. after drawing sample into the tube.

Cell : PACKTEST Square Cup  
Wavelength : 569 nm, 550 nm, 670 nm

### Procedure

1. Press **[TH]**.
2. Press **[OK]** to switch to the photometry window.
3. Fill the Cell with the sample for 1.5 mL (up to line). (Fig.1)
4. Put the Cell in the cell box and press **[Zero]**. (Fig.2)
5. Suck the whole amount of the sample in the Cell into the tube and press **[Start]** at the same time. (Fig.3)
6. Shake the tube in Step 5 about 10 times. (If the reagent is left in the tube, further shake the tube.) (Fig.4)
7. Gently return the solution in the tube to the Cell, set it again in the cell box. (Fig.5)
8. After 1 minutes have elapsed, the concentration will be automatically displayed.

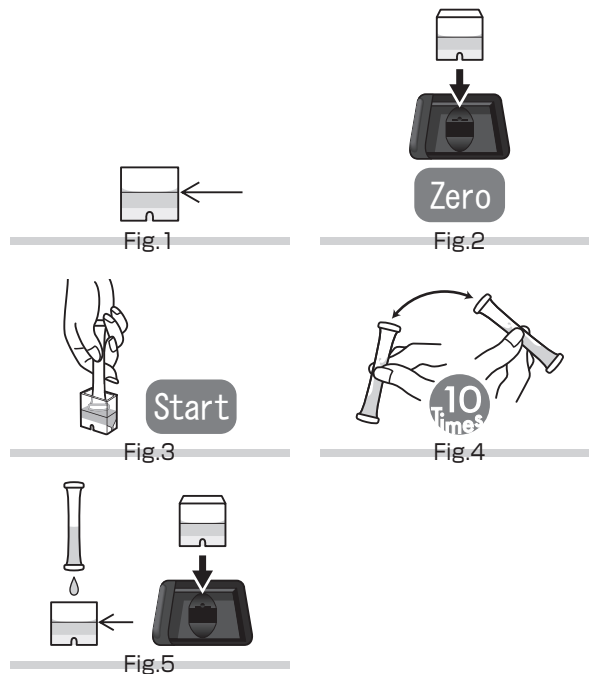

### CAUTION

1. In this method, a sample having the ratio between calcium hardness and magnesium hardness of 2:1 to 3:1 can be measured. The calibration curve has been created using 2.5:1 as the standard solution.
2. A sample with a higher percentage of calcium hardness produces a higher result, and a sample with a higher percentage of magnesium hardness produces a lower result.
3. If the total hardness value in the sample is 10 mg/L or less, color development will occur, but the result will be displayed as "UNDER".
4. The optimum pH during color development is 10. If the pH of the sample is not within the range from 5 to 10, neutralize the sample with dilute sulfuric acid or dilute sodium hydroxide solution, etc.
5. Perform measurement with the sample temperature set to 15 to 30°C .

### Influence of coexisting substance

The stored calibration curve has been created by using the standard solution. If the influence of other substance is considered, check the measurement value by comparing it with the official method or by standard addition method. The right chart is the list of interference data for acceptable level by adding each of the single substances to the standard solution.

It is not possible to measure seawater.

$\leq 1000\text{mg/L.}$ : $\text{Cl}^-$ , $\text{K}^+$ , $\text{Na}^+$ , $\text{NH}_4^+$ , $\text{NO}_2^-$ , $\text{NO}_3^-$ , $\text{PO}_4^{3-}$ , $\text{SO}_4^{2-}$ , Anionic Surfactant, Phenol
$\leq 100\text{mg/L.}$ : B (III), $\text{F}^-$ , $\text{I}^-$ , Silica
$\leq 50\text{mg/L.}$ : $\text{Ba}^{2+}$
$\leq 10\text{mg/L.}$ : $\text{CN}^-$ , Mo (VI)
$\leq 5\text{mg/L.}$ : $\text{Al}^{3+}$
$\leq 1\text{mg/L.}$ : $\text{Co}^{2+}$ , Cr (VI), $\text{Ni}^{2+}$ , Residual Chlorine
$< 1\text{mg/L.}$ : $\text{Cr}^{3+}$ , $\text{Cu}^{2+}$ , $\text{Fe}^{2+}$ , $\text{Fe}^{3+}$ , $\text{Mn}^{2+}$ , $\text{Zn}^{2+}$

### Information on reagent

Refer to the usage that comes with PACKTEST.  
The pH of the solution is about 10.

## TN-2 Total Nitrogen

Color development: Light red → Red

Method : Decomposition by Potassium Peroxodisulfate under Alkaline Condition  
+ Reduction and Naphthylethylenediamine

Cell : PACKTEST Square Cup

Wavelength : 539 nm, 580 nm

Range : 0.5 — 7.0 mg/L (ppm)

Reagent : Reagent for Total Nitrogen (Mini Autoclave) (Model : TNP-N-R)

Reaction time : 5 min. after drawing sample into the tube.

Additional tool : Mini Autoclave Set (Model: TNP-MAS), Heater

Usage : Read the instruction supplied with "Reagent for Total Nitrogen (Mini Autoclave)".

### Procedure

1. Press **[TN-2]**.
2. Press **[OK]** to switch to the photometry window.
3. Take the whole amount of the pretreated sample cooled to 20°C in the Cell, and add two droplets of R-3 reagent, attach the cap, and shake the Cell 2 to 3 times. (Fig.1)
4. Remove the cap of the Cell, put the Cell in the cell box and press **[Zero]**. (Fig.2)
5. Submerge the aperture of the tube in the sample, and the release your finger to suck the whole amount of the sample at once. At the same time, press **[Start]**. (Fig.3)
6. Shake the tube in Step 5 by overturning it to right and left for 60 times in 1 minute. (Fig.4)
7. Immediately return the solution in the tube to the Cell in a gentle manner, set it again in the cell box. (Fig.5)
8. After 5 minutes have elapsed, the concentration will be automatically displayed.

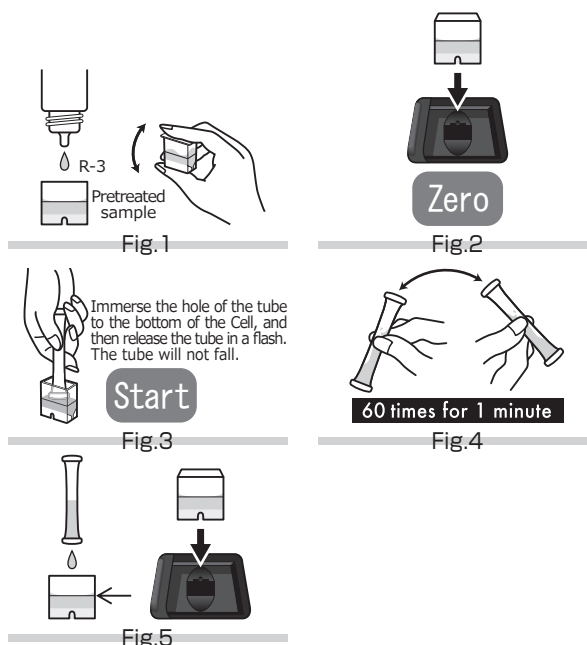

### CAUTION

1. In this method, the concentration of nitrogen in the form of ionized nitrate ion ( $\text{NO}_3^-$ ) in the pretreated sample is measured.
2. After the pretreated sample has been cooled down to 20°C, conduct the measurement.

### Influence of coexisting substance

The stored calibration curve has been created by using the standard solution. If the influence of other substance is considered, check the measurement value by comparing it with the official method or by standard addition method.

The right chart is the list of interference data for acceptable level by adding each of the single substances to the standard solution.

Measure seawater after diluting it by 10 times and pretreatment it. Oxidizing substance or reductive substance may affect the measurement. (However, in this measurement method, reductive substances are not considered left in the pretreated sample.)

$\leq 1000\text{mg/L.}; \text{B (III)}, \text{K}^+, \text{Mg}^{2+}, \text{Na}^+, \text{PO}_4^{3-}, \text{Phenol}$
$\leq 800\text{mg/L.}; \text{Cl}^-$
$\leq 200\text{mg/L.}; \text{Al}^{3+}, \text{Ca}^{2+}, \text{F}^-, \text{Ni}^{2+}$
$\leq 100\text{mg/L.}; \text{Fe}^{3+}$
$\leq 50\text{mg/L.}; \text{Co}^{2+}, \text{Zn}^{2+}$
$\leq 5\text{mg/L.}; \text{Ba}^{2+}$
$\leq 1\text{mg/L.}; \text{Cu}^{2+}, \text{Mo (VI)}$
$\leq 0.5\text{mg/L.}; \text{Cr (VI)}$

### Information on reagent

Refer to the usage that come with reagent.

The pH of the solution is 2 or less.

## TP-2 Total Phosphorus

Color development: None → Light blue → Blue

Method : Decomposition by Potassium Peroxodisulfate under Acid Condition  
+ Molybdenum blue

Range : 0.10 – 2.00 mg/L (ppm)

Reagent : Reagent for Total Phosphorus (Mini Autoclave) (Model : TNP-P-R)

Reaction time : 3 min. after drawing sample into the tube.

Additional tool : Mini Autoclave Set (Model: TNP-MAS), Heater

Usage : Read the instruction supplied with "Reagent for Total Phosphorus (Mini Autoclave)".

Cell : PACKTEST Square Cup

Wavelength : 650 nm, 580 nm

### Procedure

1. Press **[TP-2]**.
2. Press **[OK]** to switch to the photometry window
3. Take the whole amount of the pretreated sample cooled to 20°C in the Cell. (Fig.1)
4. Put the Cell in the cell box and press **[Zero]**. (Fig.2)
5. Add four droplets of R-3 reagent, attach the cap, and shake the Cell 2 to 3 times. (Fig.3)
6. Suck the whole amount of the sample in the Cell into the tube and press **[Start]** at the same time. (Fig.4)
7. Lightly shake the tube in Step 6 from 5 to 6 times, return the solution in the tube to the Cell in a gentle manner, set it again in the cell box. (Fig.5)
8. After 3 minutes have elapsed, the concentration will be automatically displayed.

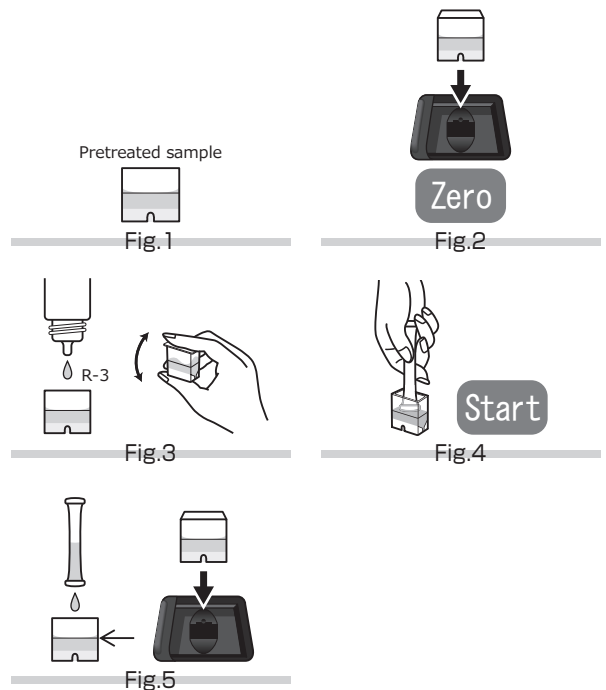

### CAUTION

1. In this method, the concentration of ionized phosphoric acid ( $\text{PO}_4^{3-}$ ) in the pretreated sample is measured.
2. After the pretreated sample has been cooled down to 20°C, conduct the measurement.  
When its temperature is between 30°C to 40°C, an approximate result can be obtained by multiplying the measurement value by 0.8.

### Influence of coexisting substance

The stored calibration curve has been created by using the standard solution. If the influence of other substance is considered, check the measurement value by comparing it with the official method or by standard addition method. The right chart is the list of interference data for acceptable level by adding each of the single substances to the standard solution.

≤ 1000mg/L.: B (III),  $\text{Cl}^-$ ,  $\text{CN}^-$ ,  $\text{K}^+$ ,  $\text{Na}^+$ ,  $\text{NO}_3^-$ ,  $\text{SO}_4^{2-}$ ,  $\text{Zn}^{2+}$   
≤ 800mg/L.:  $\text{Al}^{3+}$   
≤ 500mg/L.:  $\text{Mg}^{2+}$   
≤ 100mg/L.:  $\text{Fe}^{3+}$ ,  $\text{Ni}^{2+}$ , Silica  
≤ 50mg/L.:  $\text{Co}^{2+}$ ,  $\text{Cu}^{2+}$ ,  $\text{F}^-$   
≤ 20mg/L.:  $\text{Ca}^{2+}$ , Cr (VI), Mo (VI)  
< 1mg/L.: As (III),  $\text{Ba}^{2+}$

Seawater does not affect the measurement.

### Information on reagent

Refer to the usage that come with reagent.  
The pH of the solution is 2 or less.

## Turbid-F Turbidity (Formazine)

Measurement of turbidity of sample  
Calibration : Formazine Turbidity standard solution  
Measurement range: 10 to 400 deg.  
Reagent : not used  
Measurement time: 0 minute

Cell : PACKTEST Square Cup  
Wavelength : 660 nm

### Procedure

1. Press **[Turbid-F]**.
2. Press **[OK]** to switch to the photometry window.
3. Fill the Cell with pure water for 1.5 mL (up to line). (Fig.1)
4. Put the Cell in the cell box and press **[Zero]**. (Fig.2)
5. Take out the Cell, discard the pure water, fill the same Cell with 1.5 mL of sample. (Fig.3)
6. Set the Cell in the cell box again and press **[Start]**. (Fig.4)
7. The Turbidity will be automatically displayed.

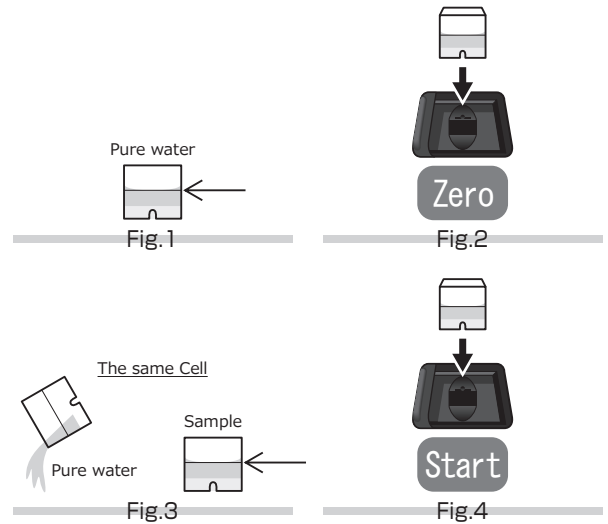

### CAUTION

Formazine turbidity is obtained in this method based on JIS K 0101 9.2 Transmitted-light turbidity.  
The principle of this method is different from Scattered-light turbidity (NTU Nephelometric Turbidity Unit).



## Turbid-P Turbidity (Polystyrene)

Measurement of turbidity of sample  
Calibration : Polystyrene Turbidity standard solution  
Measurement range: 10 to 100 deg.  
Reagent : not used  
Measurement time: 0 minute

Cell : PACKTEST Square Cup  
Wavelength : 660 nm

### Procedure

1. Press **[Turbid-P]**.
2. Press **[OK]** to switch to the photometry window.
3. Fill the Cell with pure water for 1.5 mL (up to line). (Fig.1)
4. Put the Cell in the cell box and press **[Zero]**. (Fig.2)
5. Take out the Cell, discard the pure water, fill the same Cell with 1.5 mL of sample. (Fig.3)
6. Set the Cell in the cell box again and press **[Start]**. (Fig.4)
7. The Turbidity will be automatically displayed.

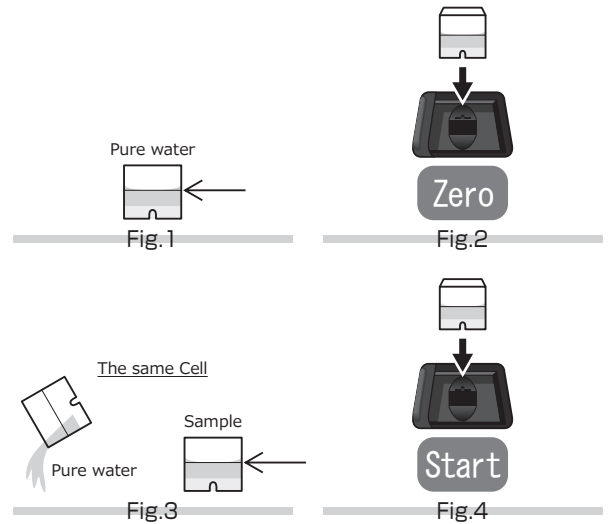

### CAUTION

Perform measurement after sufficiently shaking the sample.

## Zn-D Zinc (Low Range)

Color development: Yellow → Orange → Pink  
Method : 5-Br-PAPS  
Range : 0.02 – 0.40 mg/L(ppm)  
Reagent : WAK-Zn (D) K-1 (Small Pack) , K-2 (Liquid) , Tube  
Reaction time : 1 min. after drawing sample into the tube.

Cell : PACKTEST Square Cup  
Wavelength : 553 nm

### Procedure

1. Press **[Zn-D]**.
2. Press **[OK]** to switch to the photometry window.
3. Fill the Cell with the sample for 1.5 mL (up to line). (Fig.1)
4. Put the Cell in the cell box and press **[Zero]**. (Fig.2)
5. Add K-1 reagent, attach the cap, and sufficiently shake the Cell to completely dissolve the reagent. (Fig.3)
6. Add K-2 reagent for 0.3 mL using pipette, attach the cap and shake the Cell 2 to 3 times, and then remove the cap and let the Cell stand for 5 minutes. (Fig.4)
7. Suck the whole amount of the sample in the Cell into the tube and press **[Start]** at the same time. (Fig.5)
8. Lightly shake the tube in Step 7 about 30 times. (Fig.6)
9. Return the solution in the tube to the Cell in a gentle manner, set it again in the cell box. (Fig.7)
10. After 1 minute has elapsed, the concentration will be automatically displayed.

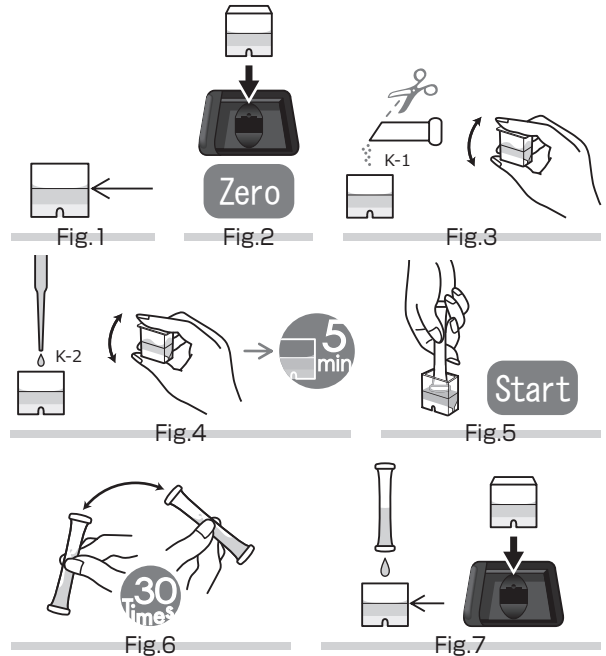

### CAUTION

1. In this method, the concentration of ionized zinc ( $Zn^{2+}$ ) in the sample is measured.  
If result of zinc concentration including suspension and precipitate is required, dissolve zinc in advance and then perform measurement.
2. The optimum pH during color development is 9. If the pH of the sample is not within the range from 5 to 10, neutralize the sample with dilute sulfuric acid or dilute sodium hydroxide solution, etc.
3. Perform measurement with the sample temperature set to 15 to 30°C .
4. Dissolve orange lumps in the tube as much as possible. Undissolved colorless reagent will not affect the measurement.
5. Use of a measuring pipette or the like instead of the supplied pipette enables more accurate measurement.

### Influence of coexisting substance

The stored calibration curve has been created by using the standard solution. If the influence of other substance is considered, check the measurement value by comparing it with the official method or by standard addition method.  
The right chart is the list of interference data for acceptable level by adding each of the single substances to the standard solution.

≤ 1000mg/L.: B (III) ,  $Ba^{2+}$  ,  $Ca^{2+}$  ,  $Cl^-$  ,  $F^-$  ,  $I^-$  ,  $K^+$  ,  $Mg^{2+}$  , Mo (VI) ,  
 $Na^+$  ,  $NH_4^+$  ,  $NO_2^-$  ,  $NO_3^-$  ,  $PO_4^{3-}$  ,  $SO_4^{2-}$  , Phenol  
≤ 50mg/L.: Residual Chlorine , Anionic Surfactant  
≤ 20mg/L.:  $CN^-$  ,  $Cr^{3+}$   
≤ 10mg/L.:  $Ag^+$  ,  $Al^{3+}$  , Cr (VI)  
≤ 1mg/L.:  $Co^{2+}$  ,  $Cu^{2+}$  ,  $Mn^{2+}$  ,  $Fe^{2+}$  ,  $Fe^{3+}$  ,  $Ni^{2+}$

Seawater does not affect the measurement.

### Information on reagent

Refer to the usage that comes with PACKTEST.  
The pH of the solution is about 9.