

Laboratory/General Use Plastic and Glass ORP Electrodes



Choice of extended rod or band-type platinum

Silver or gold versions available

Combination or half cell designs

Single or double reference junction

Sealed or refillable junctions

Glass or plastic bodies

Which material and configuration should I choose?

Sensorex makes both types—separate ORP half cells and combination ORP electrodes. The convenience of handling one combination electrode as compared to using separate ORP and reference electrodes has been well established in laboratory and portable ORP measurements. And since the price of Sensorex combination electrodes is much less than the total price of the separate electrodes, separate electrodes are used only for special purposes.

Sensorex utilizes 99.993% pure platinum rod to ensure there are no impurities in the platinum that could cause adverse reactions or interferences in ORP measurements

Glass or Plastic Body Electrodes?

Sensorex makes both body types, and they both provide identical excellent ORP measurements. Today's plastics allow ORP electrodes to be constructed with sturdy and chemically resistant epoxy or premium ULTEM bodies. A recessed protected design of the Sensorex plastic body electrodes extends over the extended tip or band measuring to ensure that the surface will not be damaged.

Single or Double Junction Reference?

Most ORP measurements can be made with single junction reference electrodes. However, materials such as heavy metals, proteins and sulfides can precipitate at the junction. Double junction designs use a buffering salt such as KNO₃ in the lower chamber contacting the sample, and prevent these reactions. For separate reference half cells, see LabSpecs.

Specifications

Wetted Materials	Epoxy (body), Glass, Platinum, Gold or silver (special versions)
Range of Measurement	+/-2000mV or range of ORP meter
Temperature/Pressure Max	176F(80C)/50psig(3.4bar)
Cable Length	30" (76cm)

Parts covered by this product data sheet include:

Model # SG500C-ORP, SG500CD-ORP, S500C-ORP, S500CD-ORP, S550C-ORP, S550CD-ORP, S510C-ORP, S510CD-ORP, S350CD-ORP, S450CD-ORP

GLASS BODY COMBINATION ORP ELECTRODES

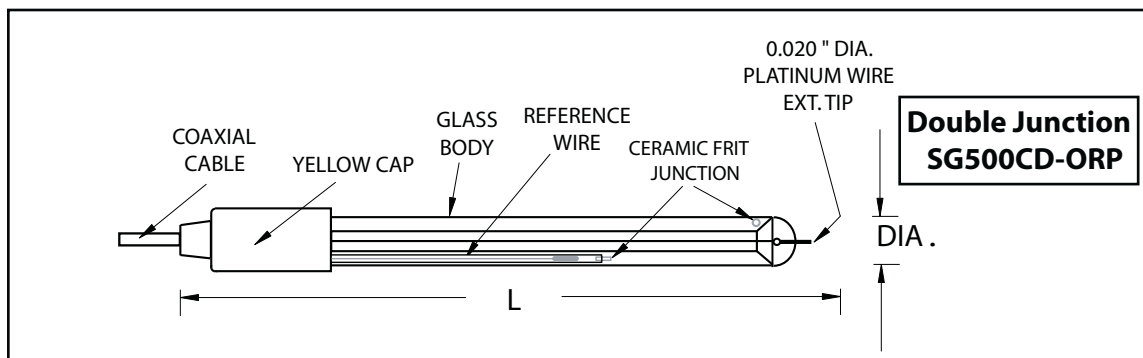
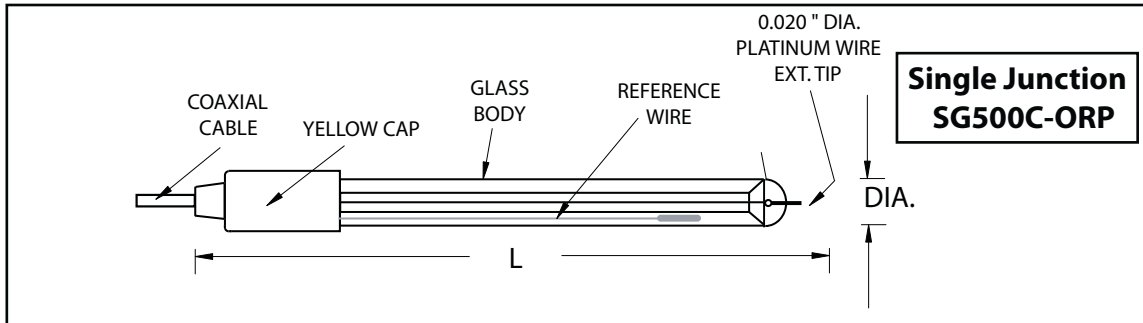

EPOXY BODY COMBINATION ORP ELECTRODES

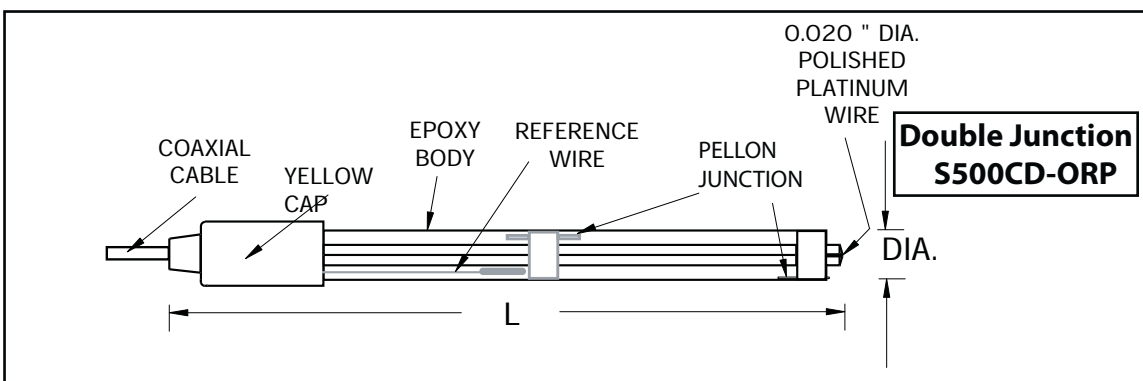
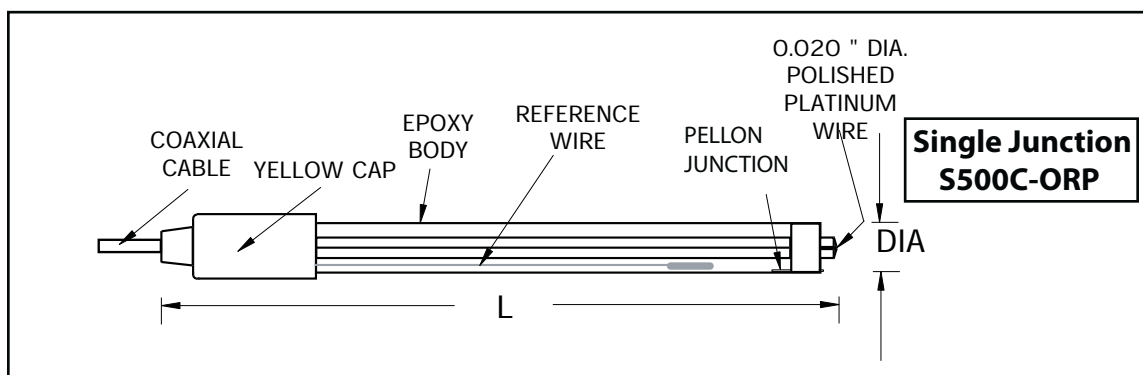

EPOXY BODY COMBINATION ORP ELECTRODES (cont.)

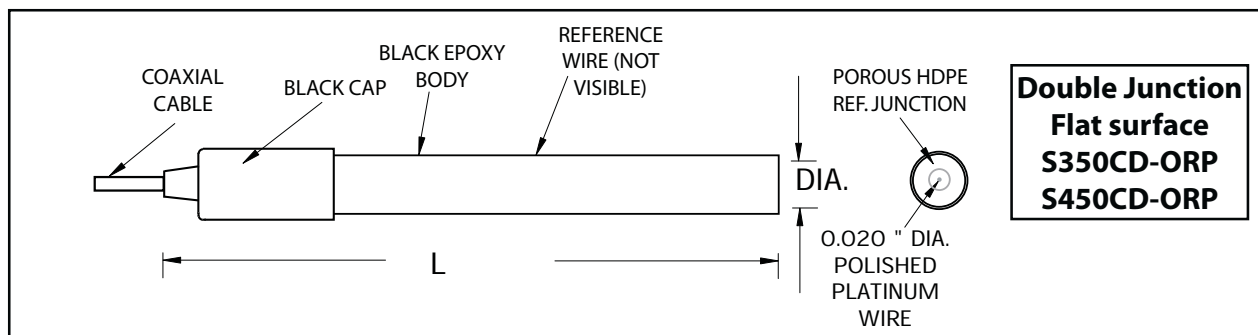
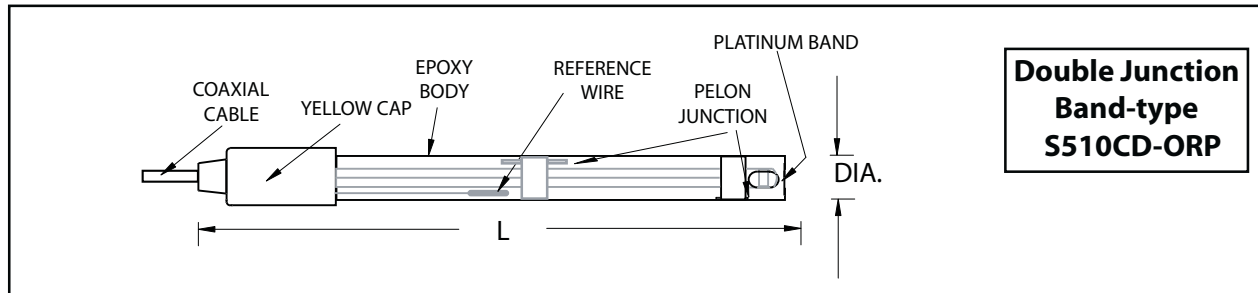
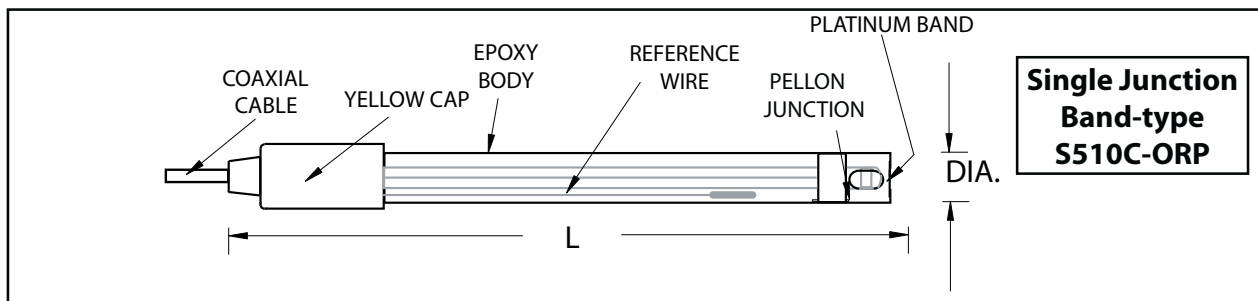
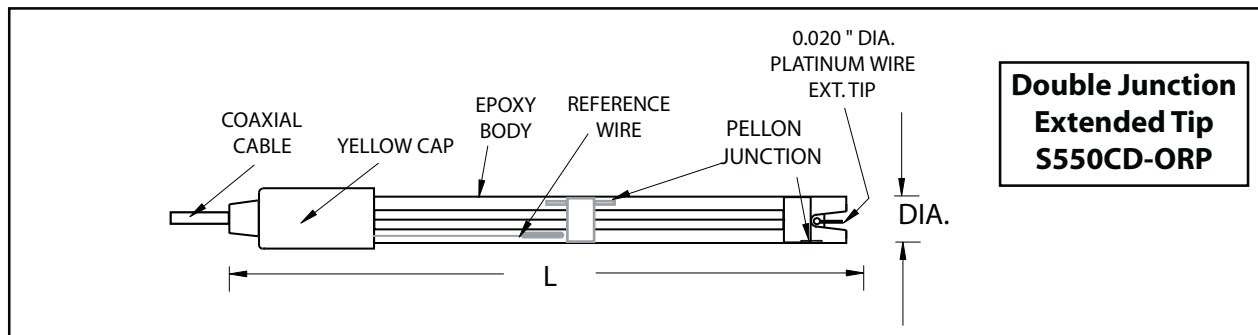
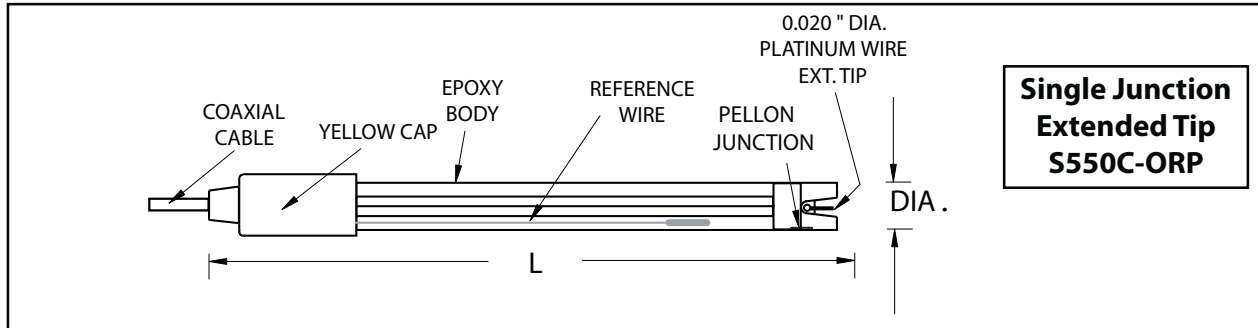

How do I choose the appropriate ORP laboratory/portable electrode for my use?

OR: Select by electrode type you currently use:

- a) Platinum, silver or gold
- b) Polished tip, exposed rod or band
- c) Sealed or re-fillable reference
- d) Epoxy or glass body
- e) Dimension required Length and diameter
- f) Separate ORP half-cell/separate reference half-cell(see LabSpecs for reference half cells)

Product Guide Lab ORP (Redox)

Application	Sensorex Part Number			
	Glass Body-	Epoxy Body-polished tip	Epoxy body - Extended tip	Epoxy Body-Band tip
Standard Laboratory	SG500C-ORP	S500C-ORP	S505C-ORP	S510C-ORP
Field Use	-----	S500CD-ORP	S505CD-ORP	S510CD-ORP
Low Ionic conditions	Inquire	S500CD-ORP-LC	Not available	Not available
Test tubes	Inquire	Not available	Not available	Not available
Tall flasks/ reactors	Inquire	Not available	S300CD-ORP	Not available
Mixed aqueous/organic	Inquire	-----	Not suggested	Not suggested
Contain Heavy metals	SG500CD-ORP	S500CD-ORP	S550CD-ORP	S510CD-ORP
Soil Samples	Not suggested	S500CD-ORP	S550CD-ORP	S510CD-ORP
Strong reducing agents (cyanide,...)	Inquire	S550CD-ORP-AU	Not available	Not suggested

Ordering Information

Model Number	Dimensions (L x Dia.)	Measuring Surface	Junction Type
S500C-ORP	6" (150mm) x 1/2" (12mm)	Platinum Polished Rod	Single Junction
S500CD-ORP	6" (150mm) x 1/2" (12mm)	Platinum Polished Rod	Double Junction
S550C-ORP	6" (150mm) x 1/2" (12mm)	Platinum Extended Tip	Single Junction
S550CD-ORP	6" (150mm) x 1/2" (12mm)	Platinum Extended Tip	Double Junction
S510C	6" (150mm) x 1/2" (12mm)	Platinum Band	Single Junction
S510CD	6" (150mm) x 1/2" (12mm)	Platinum Band	Double Junction
S550CD-ORP	6" (150mm) x 1/2" (12mm)	Gold Polished Rod	Double Junction
S350CD-ORP	6" (150mm) x 1/2" (12mm)	Platinum flat	Double Junction - HDPE
S450CD-ORP	4.5"(115mm) x 5/8" (15mm)	Platinum flat	Double Junction - HDPE
SG500C-ORP	6" (150mm) x 1/2" (12mm)	Platinum Extended Tip	Single Junction
SG500CD-ORP	6" (150mm) x 1/2" (12mm)	Platinum Extended Tip	Double Junction
S300C-ORP	12"(300mm) x 3/8" (9mm)	Platinum Extended Tip	Single Junction
S300CD-ORP	12"(300mm) x 3/8" (9mm)	Platinum Extended Tip	Double Junction

Note: All electrodes are supplied with 30" cable standard. Please specify connector type when ordering.



11751 Markon Dr.
 Garden Grove, CA 92841 USA
 Tel: 714-895-4344
 Fax: 714-894-4839
 E-mail: info@sensorex.com
 www.sensorex.com