

LAQUA



pH	ORP	Ion	Conductivity
Resistivity	Total Dissolved Solids	Salinity	

Benchtop Water Quality Instruments
Colour Touchscreen Meters



www.horiba-laqua.com



LAQUA

Benchtop Water Quality Instruments
Colour Touchscreen Meters

2011



LAQUA Benchtop Water Quality Instruments

2012



LAQUAtwin Pocket Water Quality Meters

2013



LAQUA Handheld Water Quality Instruments

2003



F-50 (desktop) The world's first pH meter with colour LCD display. Navigation panel guides operators on how to use the meter as well as resolve errors.



D-50 (portable) Waterproof, IP67-rated housing and multi-parameter.

1993



F-20 (benchtop) The world's first wireless pH meter. Large graphical display gives user instructions on screen.

1990



B-111 (Pen type) The pen type sensor allows small samples to be tested.

1987



C-1 (card) Development of the world's first flat sensor.

1980



Model F-80 (benchtop) The world's first instrument capable of measuring pH at 0.001 resolution includes an integral computer with automatic calibration and a self-diagnostic function.

L-7 (integrated) Introduction of a small, handheld pH meter with integrated electrode.



1977



Model F-7AD (benchtop) Incorporating an industry-first LCD display, the combination of a glass electrode, a reference electrode and a temperature-compensating electrode, makes testing easier.

1964



M-5 (benchtop) conversion from vacuum tube to semiconductor allows miniaturization and development of fast response meter

1950

HORIBA introduces Japan's first glass electrode pH meter.



History of the HORIBA pH Meter

The humble beginning of HORIBA...

In 1950, Dr. Masao Horiba pioneered and launched Asia's first pH meter in Kyoto, Japan. Since then, HORIBA has been introducing several of the world's firsts such as the first 0.001 resolution pH meter, the first flat sensor featured in the Cardy, the first wireless pH meter, the first colour LCD display, etc.

Touchscreen Precision. The New Benchmark.



- Large touch screen color graphic LCD—5.7 inches (115.2 x 86.4 mm)
- Chemical-resistant, 2mm thick super white glass panel with protection cover
- Easy to clean and elegant round body
- GLP / GMP compliant
- Switchable display—digital, graph, and analog
- Effortless single-touch operations—tap, flick, and drag
- 2-Channel display and simultaneous measurements for F-73 and F-74 models
- Small footprint—170 (W) x 174 (D) x 73 (H) mm
- Data acquisition software in mini USB is included
- 21 CFR Part 11 software complies with U.S. FDA's system requirements for electronic records and signatures (optional)



Protection Cover



Data Acquisition Software



21 CFR Part 11 Software

LAQUA

Benchtop Water Quality Instruments
Colour Touchscreen Meters

Intuitive Touch-Control Operation

Digital



Tap

Graph



Flick

Analog



Drag

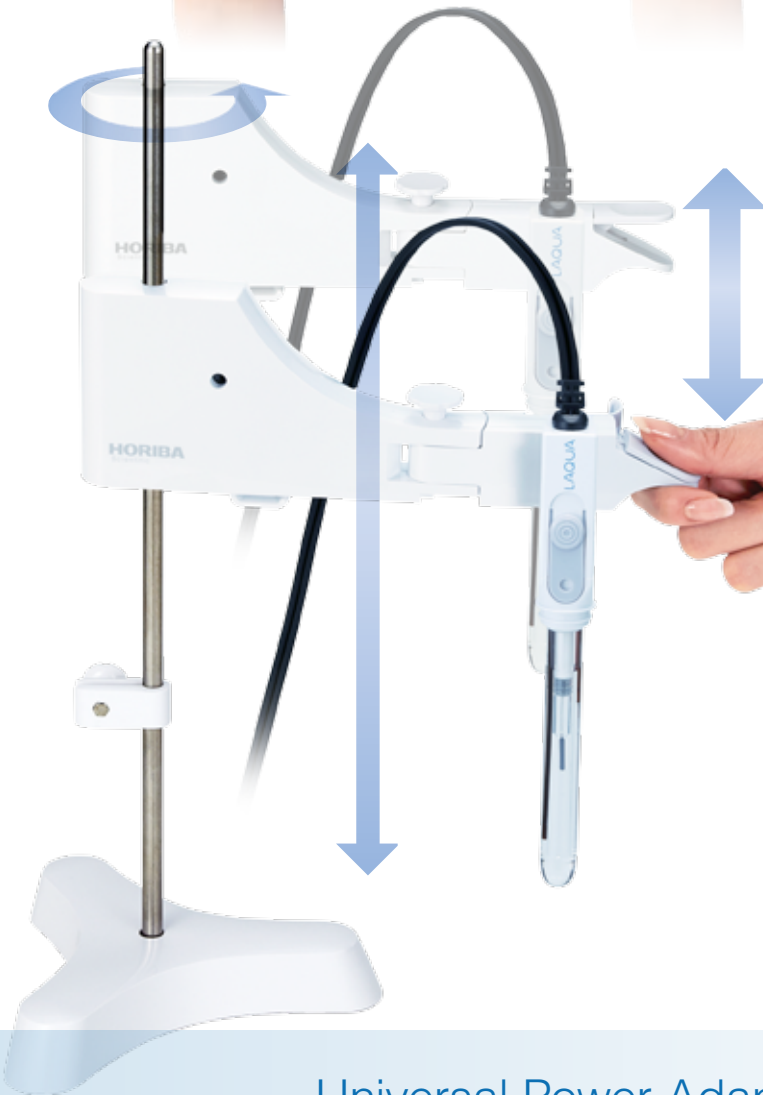

360° Electrode Stand Maneuverability

- Each meter comes with standard (Height: 384mm) electrode stand with arm
- Electrode stand arm holds up to 3 electrodes
- Taller electrode stand (Height: 650mm) with telescopic shaft is also available
- Arm level is adjusted by pressing and holding down the clip end while moving it up or down the shaft
- Stopper controls vertical slide of the electrode stand arm
- Arm rotates 360° so beakers can be conveniently positioned anywhere around the stand

Universal Power Adapter

- Multi-voltage (100-240V)
- 6 types of international standard plugs included (US, UK, EU, Australia / New Zealand, Korea and China)



Data Management

Data Key



- Data key shows settings that allow users to search, view, delete, and copy data from meter to USB flash drive

Sample ID



- Meter internal memory stores up to 2000 data with sample ID for easy reference

Data Storage

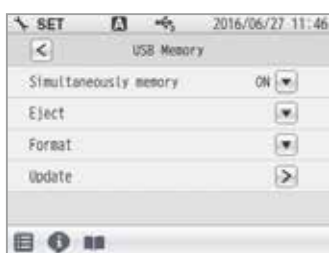

- Data can be stored simultaneously on both meter and USB flash drive (if inserted)
- Calibration and measurement data are logged automatically at set time interval

Data Search

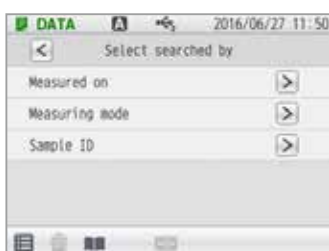

- Data search by date, parameter, or sample ID

Meter Connections



- Data output via USB to PC / USB flash drive or via RS232C to PC / printer (cables sold separately)
- Analog output adjustment—voltage output can be acquired from digital multimeter or recorder connected to the analog output connector

Custom Printout

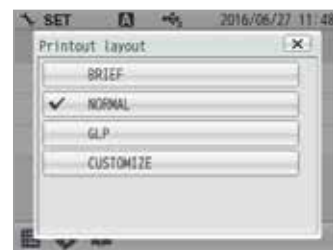

- Auto or manual printing of calibration and measurement values for record keeping
- Printout contents can be customized based on user preference or GMP/GLP requirements—date and time, operator, electrode and meter information, electrode status, and calibration data

Meter Security

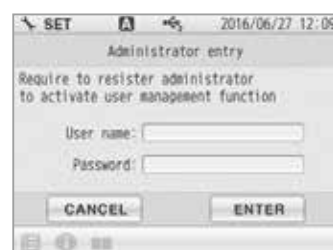

- Password setting for security
- Up to 25 administrators or operators can be registered

Intelligent Assistant

Provides step-by-step guidance on calibration, sample measurement, application methods, maintenance, inspection and troubleshooting

SMART



Calibration Support Function

Enjoy hassle-free calibration with on screen support. The meter will walk you through the steps of calibration.

- Auto Buffer Recognition
- Auto Calibration Function



Reading Stability Check

- Perform proper calibration with stable readings
- Determine the stability of reading at a glance in either digital or graph display during pH and ion calibration
- Stability value is a deviation between the maximum and minimum readings in the last 10 seconds



Electrode Status

- Electrode condition and results such as calibrated values, offset, acid and alkaline slopes, are shown at the end of calibration
- Programmable calibration reminder and alarm for measured values exceeding set limits
- Temperature indicator  appears when a temperature probe or electrode with integrated temperature sensor is connected to the meter
- Temperature sensor calibration function
- Electrode model, either selected from preset list or entered manually, and lot or MFG no. (entered manually) are included in stored data and printouts

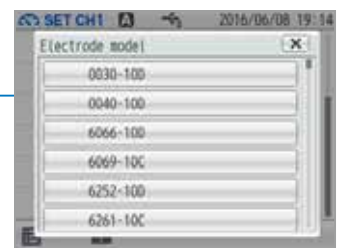

Inspection Function

Easy navigation for meter and electrode inspections using a simulator. Various industrial standards (JIS, USP, EP, JP, CP) are also supported.

- Convenient for IQ / OQ / PQ validation

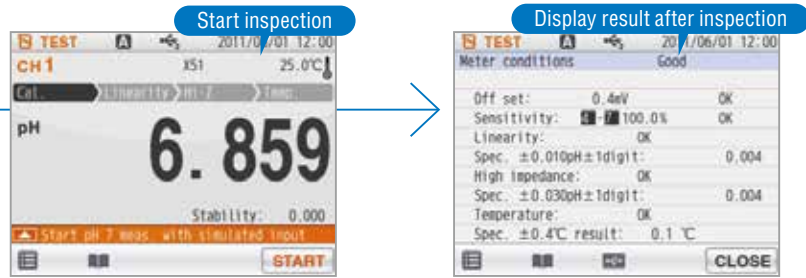

NAVIGATION

Troubleshooting Function

On-screen support for resolving a problem that occurs during calibration or sample measurements. A user's guide is incorporated in the software to assist with any operational difficulties.

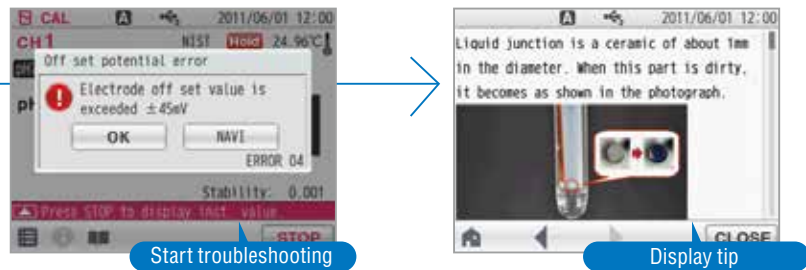

Application Functions

Various industry standard methods are supported by the instrument. Conductivity measurement for several pharmaceutical pure water guidelines and ion standard addition methods are incorporated in the meter.

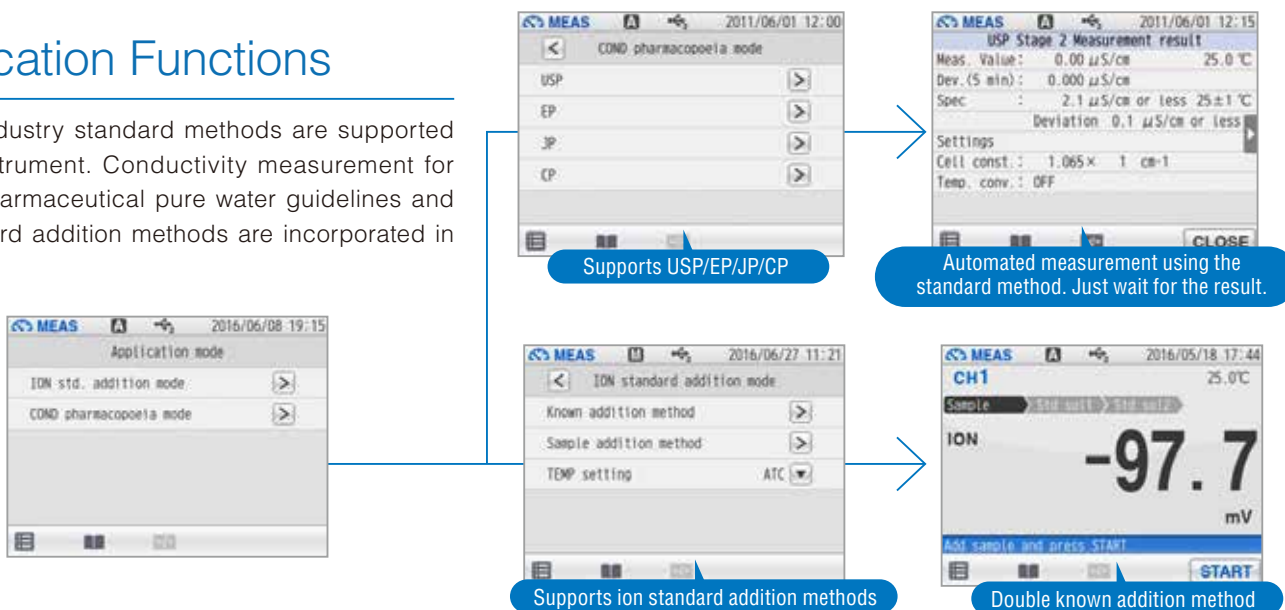

LAQUA

Benchtop Water Quality Instruments
Colour Touchscreen Meters

pH

- 5 pH buffer groups
 - USA (1.68, 4.01, 7.00, 10.01, 12.45)
 - NIST (1.68, 4.01, 6.86, 9.18, 12.45)
 - NIST2 (1.68, 4.01, 6.86, 10.01, 12.45)
 - China (1.68, 4.01, 6.86, 9.18, 12.46)
 - Custom (any pH buffers)
- Up to 5 calibration points
- 0.01 and 0.001 pH Resolutions
- Auto setting allows the meter to toggle between 0.01 and 0.001 resolution depending on the stability of the reading
- Auto calibration / Auto buffer recognition



mV

- Display absolute potential and relative potential



ADVANCED

ORP

- Capable of 1-point calibration



Ion

- Make your own calibration curve with maximum of 5 points or perform standard addition techniques
- Programmed with standard addition methods—known addition and sample addition (single and double are available for both methods)
- Measurement units - µg/L, mg/L, g/L, mmol/L, mol/L



Conductivity

- Automatic / manual calibration up to 4 points
- Adjustable temperature coefficient and reference temperature for temperature compensated readings
- Selectable cell constants – 0.1, 1.0, 10.0
- Auto ranging S/cm and S/m units, fix mS/cm unit
- Support conductivity standard methods for pharmaceutical water—USP, EP, JP and CP



Total Dissolved Solids (TDS)

- Programmed with 4 predetermined TDS curves for accurate measurement—Linear, EN27888, 442, and NaCl
- Select the TDS curve suitable for your application
- Calibration only in conductivity mode is required

TDS Calibration Curves

Application	Key chemical species	TDS selection
Aquaculture, pickling	NaCl	NaCl
Boiler water, HVAC	Na ₂ SO ₄ , NaHCO ₃ , NaCl	442 (Myron)
Environmental	EN standard for environmental water	EN 27888
General application	Not known	KCl (linear factor) Default: 0.5 Selectable: 0.4 to 1.0

Salinity

- Programmed with 2 predetermined salinity curves—NaCl and seawater
- Salinity value is calculated based on measured conductivity value
- 1-point calibration using standard solution
- Measurement units—percentage (%) and parts per thousand (ppt)

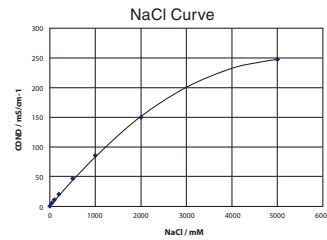

Auto Stable / Auto Hold

- In measurement mode, the meter displays live readings continuously
- Activate auto hold by tapping START
- Auto hold settings—Exact, Normal, Brief, Time, Customize, and Manual



FEATURES

Auto Log Data

- Log data automatically by setting time interval from 1 to 999 seconds

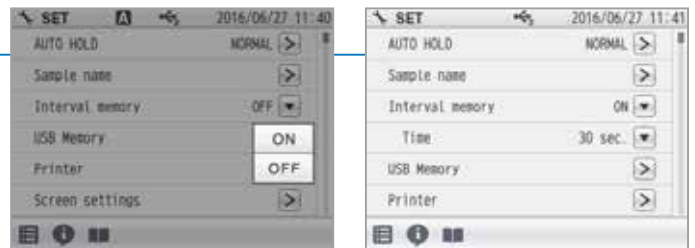

Multi-Language

- Choose a language that you are familiar with—English, Japanese, Chinese, Korean, and Vietnamese

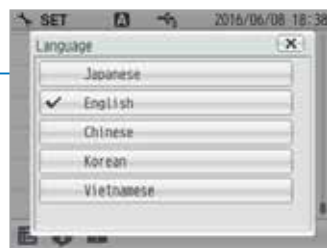

Screen Settings

- Set stylish theme on your meter screen—Standard, Cool, Monotone, and Kyoto
- Power saving mode—turns off the backlight to save power



Sound Setting

- Play a click sound every time you tap a key

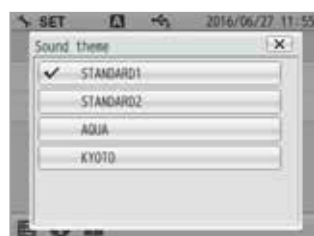
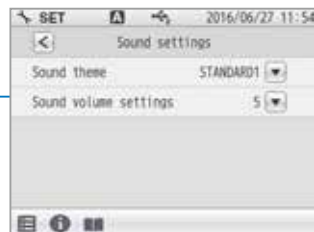





F-72
Single Channel

F-73
Dual Channel

Features:

- Up to 5 calibration points for pH and Ion
- 5 pH buffer groups – USA, NIST, NIST2, China, and Custom
- 0.01 and 0.001 pH resolutions
- pH calibration interval setting – 1 to 999 days
- 1-point ORP calibration
- Ion calibration curve and standard addition methods
- Temperature sensor calibration function
- Single channel for F-72 and dual channel display for F-73

Ordering Information:

Meter Kit*	 <p>F-72A-S (3999960011)</p> <ul style="list-style-type: none"> • F-72 meter • electrode stand • protection cover • power adaptor with 6 plugs • data acquisition software in USB • 9615S-10D - refillable, glass-body pH electrode with integrated temperature sensor, 1m cable, BNC & phono jack • 502-S - pH 4.01, 7.00, 10.01, 3.33M KCl solutions (250ml each) 	 <p>F-73A-S (3999960012)</p> <ul style="list-style-type: none"> • F-73 meter • electrode stand • protection cover • power adaptor with 6 plugs • data acquisition software in USB • 9615S-10D - refillable, glass-body pH electrode with integrated temperature sensor, 1m cable, BNC & phono jack • 502-S - pH 4.01, 7.00, 10.01, 3.33M KCl solutions (250ml each)
Meter Kit with 21 CFR Part 11 Software	F-72A-S-CFR (3999960210)	F-73A-S-CFR (3999960212)
Meter with Electrode Stand	F-72G (3000347100) <ul style="list-style-type: none"> • F-72 meter • electrode stand • protection cover • power adaptor with 6 plugs • data acquisition software in USB 	F-73G (3000347200) <ul style="list-style-type: none"> • F-73 meter • electrode stand • protection cover • power adaptor with 6 plugs • data acquisition software in USB
pH Electrode	9615S-10D (3200585428) <ul style="list-style-type: none"> • refillable, glass-body pH electrode with integrated temperature sensor, 1m cable, BNC & phono jack 	9615S-10D (3200585428) <ul style="list-style-type: none"> • refillable, glass-body pH electrode with integrated temperature sensor, 1m cable, BNC & phono jack
USA pH Buffer Set	502-S (3999960016) <ul style="list-style-type: none"> • pH 4.01, 7.00, 10.01, 3.33M KCl solutions (250ml each) 	502-S (3999960016) <ul style="list-style-type: none"> • pH 4.01, 7.00, 10.01, 3.33M KCl solutions (250ml each)
NIST pH Buffer Set	501-S (3999960015) <ul style="list-style-type: none"> • pH 4.01, 6.86, 9.18, 3.33M KCl solutions (250ml each) 	501-S (3999960015) <ul style="list-style-type: none"> • pH 4.01, 6.86, 9.18, 3.33M KCl solutions (250ml each)

*Kit with 501-S is available upon request. Add 'N' suffix to the order code when ordering.

Model	F-72 pH/ORP/Ion/Temp (°C)	F-73 Dual Channel pH/ORP/Ion/Temp (°C)
pH Range	-2.000 to 20.000 pH	-2.000 to 20.000 pH
Resolution	0.01 / 0.001 pH	0.01 / 0.001 pH
Accuracy	± 0.001 pH	± 0.001 pH
Calibration Points	Up to 5	Up to 5
Buffer Options	USA, NIST, NIST2, China, Custom	USA, NIST, NIST2, China, Custom
ORP Range	± 1999.9 mV	± 1999.9 mV
Resolution	0.1 mV	0.1 mV
Accuracy	±0.2 mV	±0.2 mV
Ion Range	0.000 µg/L to 9999 g/L (mol/L)	0.000 µg/L to 9999 g/L (mol/L)
Resolution	4 significant digits	4 significant digits
Accuracy	± 0.3% of full scale	± 0.3% of full scale
Calibration Points	Up to 5	Up to 5
Temperature Range	-30.0 °C to 130.0 °C	-30.0 °C to 130.0 °C
Resolution	0.1 °C	0.1 °C
Accuracy	±0.4°C	±0.4°C
Calibration Option	Yes	Yes
Navigation Function	Yes	Yes
Memory	2000	2000
Auto Data-Logging	Yes	Yes
Data Search	Yes	Yes
Custom Printing	Yes	Yes
Real Time Clock	Yes	Yes
Date / Time Stamp	Yes	Yes
Sample ID Input	Yes	Yes
Operator ID Input	Yes	Yes
Password Setting	Yes	Yes
Auto Stable / Auto Hold	Yes	Yes
Offset / Slope Display	Yes (independent acid and alkaline slopes depending on calibration)	Yes (independent acid and alkaline slopes depending on calibration)
Calibration Alarm Limit	Yes	Yes
Electrode Status	On screen display	On screen display
Diagnostic Messages	Yes	Yes
Display	Touch screen color graphic LCD	Touch screen color graphic LCD
Languages	English / Japanese / Chinese / Korean / Vietnamese	English / Japanese / Chinese / Korean / Vietnamese
Inputs	BNC, phono, DC socket	Dual BNC, dual phono, DC socket
Outputs	USB, RS232C, analog output	USB, RS232C, analog output
Power Requirements	AC adaptor 100 ~ 240V, 50/60 Hz	AC adaptor 100 ~ 240V, 50/60 Hz
Electrode Stand	Stand alone	Stand alone
Weight	700g	700g
Dimensions	170 (W) x 174 (D) x 73 (H) mm	170 (W) x 174 (D) x 73 (H) mm

Features:

- Wide conductivity range
- Automatic / manual conductivity calibration
- Up to 4 calibration points
- Adjustable temperature coefficient, reference temperature, and cell constant
- Temperature sensor calibration function
- Auto ranging S/cm and S/m and fix mS/cm conductivity units
- Parts per thousand (ppt) and percentage (%) salinity units
- NaCl and seawater salinity curves
- 4 Total dissolved solids (TDS) curves – EN27888, Linear, NaCl, 442

DS-72 Single Channel

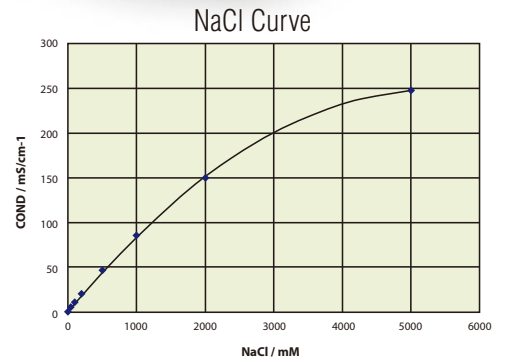
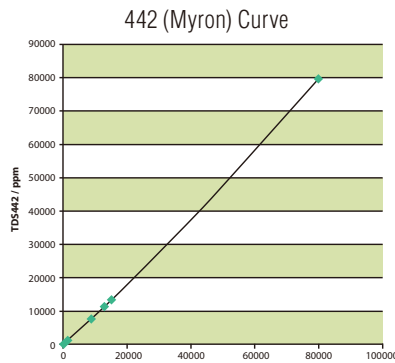
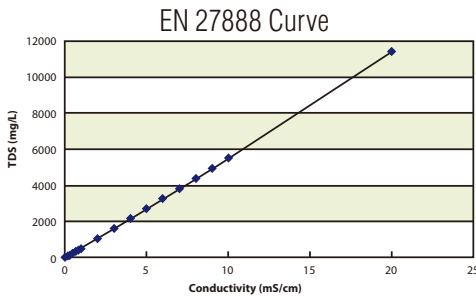

Ordering Information:

<p>Meter Kit</p>	 <p>DS-72A-S (3999960013)</p> <ul style="list-style-type: none"> • DS-72 meter • electrode stand • protection cover • power adaptor with 6 plugs • data acquisition software in USB • 3552-10D - Platinum/Platinum black, glass-body k=1.0 conductivity cell with integrated temperature sensor, 1m cable, BNC & phono jack • 503-S - 84µS/cm, 1413µS/cm, 12.88mS/cm & 111.8mS/cm conductivity standard solutions (250ml each)
<p>Meter Kit with 21 CFR Part 11 Software</p>	<p>DS-72A-S-CFR (3999960216)</p>
<p>Meter with Electrode Stand</p>	<p>DS-72G (3000347600)</p> <ul style="list-style-type: none"> • DS-72 meter • electrode stand • protection cover • power adaptor with 6 plugs • data acquisition software in USB
<p>Conductivity Cell</p>	<p>3552-10D (3014081545)</p> <ul style="list-style-type: none"> • Platinum/Platinum black, glass-body k=1.0 conductivity cell with integrated temperature sensor, 1m cable, BNC & phono jack
<p>Conductivity Standard Solutions Set</p>	<p>503-S (3999960017)</p> <ul style="list-style-type: none"> • 84µS/cm, 1413µS/cm, 12.88mS/cm & 111.8mS/cm conductivity standard solutions (250ml each)

Model	DS-72 EC/TDS/Res/Sal/Temp (°C)
EC Range	0.000 µS/cm to 19.99 mS/cm (k=0.1) 0.00 µS/cm to 199.9 mS/cm (k=1.0) 0.0 µS/cm to 1.999 S/cm (k=10.0)
Resolution	0.05% of full scale
Accuracy	±0.6% of full scale (±1.5% full scale > 18.0 mS/cm)
Reference Temperature	15 to 30°C (adjustable)
Temperature Coefficient	0.00 to 10.00% (adjustable)
Cell Constants	0.1 / 1.0 / 10.0
Calibration Points	4 (Auto / Manual)
Measurement Units	Auto-Ranging / Manual S/cm, S/m, Fix (mS/cm)
TDS Range	0.01 mg/L to 1000 g/L
Resolution	0.01 mg/L
Accuracy	±0.1% of full scale
TDS Curves	EN27888, Linear (0.40 to 1.0), 442, NaCl
Resistivity Range	0.00 kΩ.cm to 199.9 MΩ•cm (k=0.1) 0.000 kΩ.cm to 19.99 MΩ•cm (k=1.0) 0.0 Ω.cm to 1.999 MΩ•cm (k=10.0)
Resolution	0.05% of full scale
Accuracy	±0.6% of full scale (±1.5% full scale > 1.80 MΩ•cm)
Salinity Range	0.00 to 80.00 ppt / 0.000 to 8.000%
Resolution	0.01 ppt / 0.001%
Accuracy	0.2% of full scale
Salinity Curves	NaCl / Seawater
Temperature Range	-30.0 °C to 130.0 °C
Resolution	0.1 °C
Accuracy	± 0.4 °C
Navigation Function	Yes
Memory	2000
Auto Data-Logging	Yes
Data Search	Yes
Custom Printing	Yes
Real Time Clock	Yes
Date / Time Stamp	Yes
Sample ID Input	Yes
Operator ID Input	Yes
Password Setting	Yes
Auto Stable / Auto Hold	Yes
Diagnostic Messages	Yes
Display	Touch screen color graphic LCD
Languages	English / Japanese / Chinese / Korean / Vietnamese
Inputs	BNC, phono, DC socket
Outputs	USB, RS232C, analog output
Power Requirements	AC adaptor 100~240V, 50/60 Hz
Electrode Stand	Stand alone
Weight	700g
Dimensions	170 (W) x 174 (D) x 73 (H) mm

Features:

- Combine the functions of F-72 and DS-72 models
- Dual channel and simultaneous measurements
 - Channel 1: pH, Ion, mV, ORP
 - Channel 2: Conductivity, Salinity, Resistivity and TDS
- Switchable single or dual channel display

F-74
Dual Channel



Channel 1: pH



Channel 2: Conductivity



Dual Channel

Ordering Information:

Meter Kit*	<p>F-74A-S (3999960014)</p> <ul style="list-style-type: none"> • F-74 meter • electrode stand • protection cover • power adaptor with 6 plugs • data acquisition software in USB • 9615S-10D - refillable, glass-body pH electrode with integrated temperature sensor, 1m cable, BNC & phono jack • 3552-10D - Platinum/Platinum black, glass-body k=1.0 conductivity cell with integrated temperature sensor, 1m cable, BNC & phono jack • 502-S - pH 4.01, 7.00, 10.01, 3.33M KCl solutions (250ml each) • 503-S - 84µS/cm, 1413µS/cm, 12.88mS/cm & 111.8mS/cm conductivity standard solutions (250ml each)
Meter Kit with 21 CFR Part 11 Software	<p>F-74A-S-CFR (3999960214)</p>
Meter with Electrode Stand	<p>F-74G (3000347400)</p> <ul style="list-style-type: none"> • F-74 meter • electrode stand • protection cover • power adaptor with 6 plugs • data acquisition software in USB
pH Electrode	<p>9615S-10D (3200585428)</p> <ul style="list-style-type: none"> • refillable, glass-body pH electrode with integrated temperature sensor, 1m cable, BNC & phono jack
Conductivity Cell	<p>3552-10D (3014081545)</p> <ul style="list-style-type: none"> • Platinum/Platinum black, glass-body k=1.0 conductivity cell with integrated temperature sensor, 1m cable, BNC & phono jack
USA pH Buffer Set	<p>502-S (3999960016)</p> <ul style="list-style-type: none"> • pH 4.01, 7.00, 10.01, 3.33M KCl solutions (250ml each)
NIST pH Buffer Set	<p>501-S (3999960015)</p> <ul style="list-style-type: none"> • pH 4.01, 6.86, 9.18, 3.33M KCl solutions (250ml each)
Conductivity Standard Solutions Set	<p>503-S (3999960017)</p> <ul style="list-style-type: none"> • 84µS/cm, 1413µS/cm, 12.88mS/cm & 111.8mS/cm conductivity standard solutions (250ml each)

*Kit with 501-S is available upon request. Add 'N' suffix to the order code when ordering.

F-74	
Dual Channel pH/ORP/Ion/EC/TDS/Res/Sal/Temp (°C)	
Models	
pH Range	-2.000 to 20.000 pH
Resolution	0.01 / 0.001 pH
Accuracy	± 0.001 pH
Calibration Points	Up to 5
Buffer Options	USA, NIST, NIST2, China, Custom
ORP Range	± 1999.9 mV
Resolution	0.1 mV
Accuracy	± 0.2 mV
Ion Range	0.000 µg/L to 9999 g/L (mol/L)
Resolution	4 significant digits
Accuracy	± 0.3% of full scale
Calibration Points	Up to 5
EC Range	0.000µS/cm to 19.99mS/cm (k=0.1) 0.00 µS/cm to 199.9 mS/cm (k=1.0) 0.0 µS/cm to 1.999 S/cm (k=10.0)
Resolution	0.05% of full scale
Accuracy	±0.6% of full scale (±1.5% full scale > 18.0 mS/cm)
Reference Temperature	15 to 30°C (adjustable)
Temperature Coefficient	0.00 to 10.00% (adjustable)
Cell Constants	0.1 / 1.0 / 10.0
Calibration Points	4 (Auto / Manual)
Measurement Units	Auto Ranging / Manual S/cm, S/m, Fix (mS/cm)
TDS Range	0.01 mg/L to 1000 g/L
Resolution	0.01 mg/L
Accuracy	±0.1% of full scale
TDS Curves	EN27888, Linear (0.40 to 1.0), 442, NaCl
Resistivity Range	0.00 kΩ.cm to 199.9 MΩ•cm (k=0.1) 0.000 kΩ.cm to 19.99 MΩ•cm (k=1.0) 0.0 Ω.cm to 1.999 MΩ•cm (k=10.0)
Resolution	0.05% of full scale
Accuracy	±0.6% of full scale (±1.5% full scale > 1.80 MΩ•cm)
Salinity Range	0.00 to 80.00 ppt / 0.000 to 8.000 %
Resolution	0.01 ppt / 0.001%
Accuracy	0.2% of full scale
Salinity Curves	NaCl / Seawater
Temperature Range	-30.0 °C to 130.0 °C
Resolution	0.1 °C
Accuracy	± 0.4 °C
Navigation Function	Yes
Memory	2000
Auto Data-Logging	Yes
Data Search	Yes
Custom Printing	Yes
Real Time Clock	Yes
Date / Time Stamp	Yes
Sample ID Input	Yes
Operator ID Input	Yes
Password Setting	Yes
Auto Stable / Auto Hold	Yes
Offset / Slope Display	Yes (independent acid and alkaline slopes depending on calibration)
Calibration Alarm Limit	Yes
Electrode Status	On screen display
Diagnostic Messages	Yes
Display	Touch screen color graphic LCD / dual channel display
Languages	English / Japanese / Chinese / Korean / Vietnamese
Inputs	Dual BNC, dual phono, DC socket
Outputs	USB, RS232C, analog output
Power Requirements	AC adaptor 100~240V, 50/60 Hz
Electrode Stand	Stand alone
Weight	700g
Dimensions	170 (W) x 174 (D) x 73 (H) mm

pH Electrode Selection Guide

		3-in-1 ELECTRODES											COMBINATION ELECTRODES				
		PLASTIC				STANDARD ToupH	LONG ToupH	MICRO ToupH	SLEEVE ToupH	SLEEVE	NON-AQUEOUS	NEEDLE	PLASTIC	STANDARD ToupH	MICRO ToupH	SLEEVE ToupH	LONG
		9625-10D	9630-10D	9631-10D	9632-10D	9615S-10D	9680S-10D	9618S-10D	9681S-10D	6367-10D	6377-10D	6252-10D	9425-10C	9415-10C	9418-10C	9481-10C	6069-10C
Specification	Applicable temperature range (°C)	0-100	0-100	0-60	0-100	0-100	0-100	0-60	0-60	0-60	0-60	0-60	0-100	0-100	0-60	0-60	0-60
	Diameter (mm)	16	16	16	16	12	8	3	12	12	12	12	16	12	3	12	3
	Length (mm)	150	150	155	150	198	283	185	203	150	150	150	150	198	185	203	291

pH - Sample Conditions

Aqueous Solution	Conductivity	Normal (over 100 mS/m)	●	●	●	●	●	●	●	●	●	●	●	●	●	●	●	
		Low (approx. 10 -100 mS/m)		●						○		●				○		
		Very low (approx. 5 -100 mS/m)		○						○		●				○		
		High (approx. 5 S/m)	○	○	○	○	○	○		●				○	○		●	
	Strong alkaline (pH 10-12)				●	○	○		○	○				○		○		
	Strong acidity (pH 0-2) * Except HF sample			●		●								●				
	Quick heat change (within 50°C)	●	●	●	●								●					
	High viscosity (approx. 5 Pa-S)									●	○	●				●		
Solid/ Semisolid	Containing non-aqueous solvent					○	○	○	○	○	○	○		○	○	○	○	
		Suspension					○	○	○	●		●			○	○	●	
		Inside											○					
Surface																		

Sample Containers	Microtube/plate (> 50 µL)								●							●	
	Ampule > ø4 mm								●							●	○
	Micro container (> 2 mL)							○	●							●	○
	Tube ID:13 mm, L:100 - 150 mm							●									●
	Beaker 10 mL - 1 L	●	●	●	●	●	○	○	○	○	○	○	○	○	○	○	○
	Large container (> 1 L)	○	○	○	○	○	○	●						○	○		
	Petri dish																
	Droplet																

Water	Pure/ion-exchange water (approx. 0.1 mS/m)/ Distilled water (approx. 0.5 mS/m)											●				○	
	Tap/drinking water (approx. 10 mS/m)	○	●			○				○		●			○	○	
	Surface water		●			○				○		●			○	○	
	Pharmaceutical water/ Environmental water/acid rain	○	○			○				○		○			○	○	
Chemical reagent/ solvent	Caustic/strong acid (Except HF sample)			●		●				○				●		○	
	Hydrofluoric acid			●													
	Surfactant					○				●		○			○	●	
	Water-based paint					○				●		○			○	●	
	Dye/coloring agent									●		○				●	
Pharmaceutical/ biological sample	Protein-containing sample					○		○	●	○				○	○	●	
	Medicinal preparation							○	○			○			○	○	
	Enzyme solution						○	○	●			○			●		
	Tris buffer					●		○	○					●	○	○	
	Suspension					○				●		●			○	○	●
	Agar medium																
Food	Jam					○				●		○	○		○	○	●
	Meat/fish/Fruit/vegetable/ Dough												●				
	Honey											●					
	Cheese/butter																○
	Yogurt	○	○			○				○	○		○	○		○	
Beverage/ seasoning	Beer	○	○			○				●	○	●		○	○	●	
	Milk/Carbonated drink/juice/ sauce/soy sauce					○				●	○	○			○	○	●
	Mayonnaise/ketchup					○				●		○			○	○	●
Cosmetic/ lotion	Beauty cream/mascara					○				●		○	○		○	○	●
	Gel/soap/shampoo/Hair dye lotion					○				●		○			○	○	●
	Emulsified liquid					○				○		●			○	○	

● Recommended ○ Can be measured

ISFET ELECTRODE		
LONG ToupH	FLAT	GENERAL
9480-10C	6261-10C	0040-10D
0-100	0-50	0-60
8	12	16
283	150	190

●	●	●
○		
○		
○		○
○		○
	●	●

○		
●		
○	○	○
●		
	●	●
	●	●

○		
	●	●
	○	●(surface)
	○	●(surface)
		○(surface)
	○	○(surface)
	○	●(surface)

Stable measurement for a wide range of samples. Standard **ToupH** glass electrode (9615S-10D)

STANDARD ToupH



High stability and drift reduction. No more worries about the timing of your measurement value readings.

- Uses responsive glass that is 10 times stronger than JIS standard. The domed shape provides strength in all directions, greatly reducing damage concerns.
- Constructed with smooth surfaces for easy wiping and cleaning.

Recommended

Perfect for preparing buffers. Can be used on a wide range of aqueous test solutions.

Stable measurement for routine testing. Standard plastic electrode (9625-10D)

STANDARD



The electrode has a plastic body which is ideal for general purpose measurement.

- Can be submerged up to 1m depth and 30mins. (with refilling port closed)
- Waterproof, Pb-free

Recommended

Ideal for general purpose use. For measurement of tap water and drinking water.

For extremely small samples Micro **ToupH** glass electrode (9618S-10D)

MICRO ToupH



This pH electrode with temperature compensation sensor can take measurements from samples as small as 50µL, the smallest in the world.

- Our original manufacturing technology (Japanese Patent No. 4054245) is used to produce 2-ply piping 3mm in diameter.
- Compatible with extremely small containers such as micro tubes etc.
- The temperature sensor is located at the tip for high-speed temperature response. Refrigerated samples can be measured without needing to wait for them to return to room temperature.

Recommended

Can be used for a wide range of aqueous solutions, including those that cannot be obtained in large quantities. We recommend using our specialized cleaning solution after measuring samples that contain proteins.

For using a large container Long **ToupH** glass electrode (9680S-10D)

LONG ToupH



283 mm length & 8 mm diameter. The long, thin design makes this electrode perfect for measuring in large containers and test tubes.

- Uses responsive glass that is 10 times stronger than JIS standard. The domed shape provides strength in all directions, greatly reducing damage concerns.

Recommended

For measuring samples such as microbe culture fluids in test tubes. We recommend that it be used with the long type electrode stand (FA-70L).

For highly viscous samples Sleeve **ToupH** glass electrode (9681S-10D)

SLEEVE ToupH



Stable measurement can also be achieved for high viscous samples.

- The liquid junction section is constructed with a movable sleeve that can be rinsed clean, preventing highly viscous samples from clogging the liquid junction, and maintaining stable measurement performance

Recommended

For highly viscous samples and solutions, and samples that contain non-aqueous solvents (such as cosmetics or paints). We recommend that you take measurements while using the graph display function to confirm stable responses. (We recommend washing with a neutral detergent after use with samples that contain oil.)

For the surface of solid samples General ISFET pH electrode (0040-10D)

GENERAL ISFET



The sensor is located on the flat surface of the electrode tip, with less than a 100 µm protrusion from the housing.

- Measurements can be made from a minute amount of moisture on the solid sample surface.
- Use of a semiconductor sensor means there are no concerns that the electrode will be damaged.
- Also perfect for measuring samples in shallow containers such as Petri dishes.
- Replaceable sensor







Recommended

For highly viscous samples and solutions, and samples that contain non-aqueous solvents (such as cosmetics or paints). We recommend that you take measurements while using the graph display function to confirm stable responses. (We recommend washing with a neutral detergent after use with samples that contain oil.)





Combination ISE

Ion-selective electrodes are responsive to concentration of particular ions in the test liquid and are variable-potential electrodes. They are used in conjunction with reference electrodes to measure the concentration of particular ions. HORIBA's years of experience and know-how in this field are behind the wide range of ion electrodes we offer.

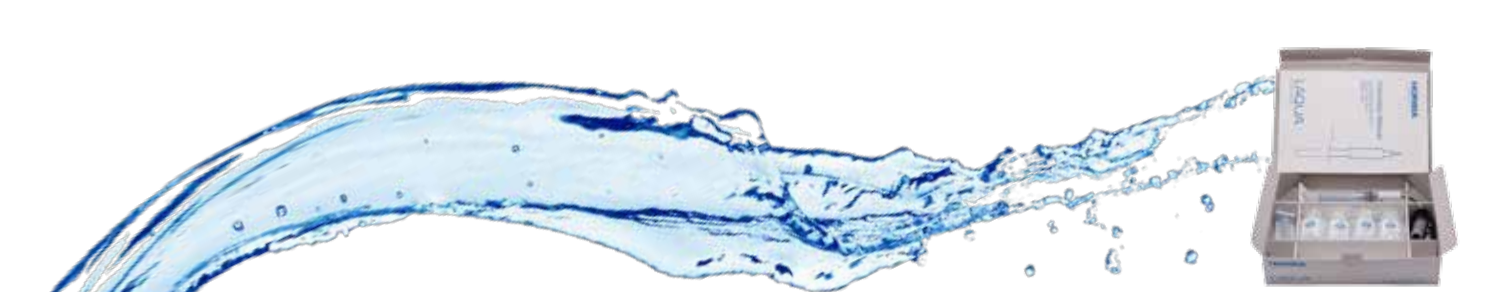
When measurements are made using an ion meter, calibrating it with various standard solutions will give direct readings of the ion concentration. Note that since volume-detection level changes with temperature, measurements must be taken at a fixed temperature.

Model	Accessories Included	Temp. Range (°C)	Measurement Range	pH Range
 <p>Ammonia ion (NH₃) electrode 5002S-10C 3200698386 Overall length: 161 mm Diameter of probe: 15 mm Connector: BNC</p>	<ul style="list-style-type: none"> • membrane cap, 3pcs • 1000mg/L ammonium ion standard solution, 50ml • 100mg/L ammonium ion standard solution, 50ml • ammonia electrode filling solution, 50ml • syringe • dropper • protective pipe • manual 	0 - 50	0.01 - 18,000 mg/L NH ₄ ⁺ (5 x 10 ⁻⁷ to 1 mol/L NH ₄ ⁺)	pH 12 or more
 <p>Calcium ion (Ca²⁺) electrode 6583S-10C 3200697410 Overall length: 150 mm Diameter of probe: 16 mm Connector: BNC</p>	<ul style="list-style-type: none"> • calcium electrode tip, 2pcs • 1000mg/L calcium ion standard solution, 50ml • 100mg/L calcium ion standard solution, 50ml • calcium electrode filling solution, 50ml • calcium ionic strength adjustor, 50ml • syringe • dropper • protective pipe • manual 	0 - 50	0.4 - 40,080 mg/L Ca ²⁺ (10 ⁻⁵ to 1 mol/L Ca ²⁺)	4.0 mg/L (10 ⁻⁴ mol/L) Ca ²⁺ , pH 5 to 11
 <p>Chloride ion (Cl⁻) electrode 6560S-10C 3200697407 Overall length: 150 mm Diameter of probe: 16 mm Connector: BNC</p>	<ul style="list-style-type: none"> • chloride electrode tip • 1000mg/L chloride ion standard solution, 50ml • 100mg/L chloride ion standard solution, 50ml • chloride electrode filling solution, 50ml • chloride ionic strength adjustor, 50ml • syringe • dropper • protective pipe • water-resistant abrasive sheet • manual 	0 - 50	0.35 - 35,000 mg/L Cl ⁻ (10 ⁻⁵ to 1 mol/L Cl ⁻)	350 mg/L (10 ⁻² mol/L) Cl ⁻ , pH 3 to 11
 <p>Fluoride ion (F⁻) electrode 6561S-10C 3200693774 Overall length: 150 mm Diameter of probe: 16 mm Connector: BNC</p>	<ul style="list-style-type: none"> • fluoride electrode tip • 1000mg/L fluoride ion standard solution, 50ml • 100mg/L fluoride ion standard solution, 50ml • fluoride electrode filling solution, 50ml • fluoride ionic strength adjustor, 50ml • syringe • dropper • protective pipe • manual 	0 - 50	0.02 - 19,000 mg/L F ⁻ (10 ⁻⁶ to 1 mol/L F ⁻)	0.1 to 1,000 mg/L F ⁻ , pH 5 to 8
 <p>Nitrate ion (NO₃⁻) electrode 6581S-10C 3200697408 Overall length: 150 mm Diameter of probe: 16 mm Connector: BNC</p>	<ul style="list-style-type: none"> • nitrate electrode tip, 2pcs • 1000mg/L nitrate ion standard solution, 50ml • 100mg/L nitrate ion standard solution, 50ml • nitrate electrode filling solution, 50ml • nitrate ionic strength adjustor, 50ml • syringe • dropper • protective pipe • manual 	0 - 50	0.62 - 62,000 mg/L NO ₃ ⁻ (10 ⁻⁵ to 1 mol/L NO ₃ ⁻)	62 mg/L (10 ⁻³ mol/L) NO ₃ ⁻ , pH 3 to 7
 <p>Potassium ion (K⁺) electrode 6582S-10C 3200697409 Overall length: 150 mm Diameter of probe: 16 mm Connector: BNC</p>	<ul style="list-style-type: none"> • potassium electrode tip, 2pcs • 1000mg/L potassium ion standard solution, 50ml • 100mg/L potassium ion standard solution, 50ml • potassium electrode filling solution, 50ml • potassium ionic strength adjustor, 50ml • syringe • dropper • protective pipe • manual 	0 - 50	0.39 - 39,000 mg/L K ⁺ (10 ⁻⁵ to 1 mol/L K ⁺)	3.9 mg/L (10 ⁻⁴ mol/L) K ⁺ , pH 5 to 11







Selection Coefficient	Replacement Tip	Electrode Filling Solution	100mg/L Standard Solution	1000mg/L Standard Solution	Ionic Strength Adjustor	Applications
—	 <p>NH₃ electrode membrane caps 3200705774</p>	500-NH3-IFS 3200697173	500-NH4-SL 3200697172	500-NH4-SH 3200697171	500-NH3-ISA 3200697174 	Agriculture, Soil, Power Station Water, Fish Tanks, Sea Water, Waste Water, Plating Baths, Air / Stack Gases and Biological Cultures or Samples
$Fe^{3+} = 0.1, Fe^{2+}, Zn^{2+} = 1, Sr^{2+} = 50$ $Ni^{2+}, Cu^{2+} = 70, Co^{2+} = 350$ $Mn^{2+} = 500, Mg^{2+} = 1,000$ $Na^+, K^+, Ba^{2+}, NH_4^+ = \text{over } 1,000$	 <p>7683S 3200697414</p>	500-CA-IFS 3200697177	500-CA-SL 3200697176	500-CA-SH 3200697175	500-CA-ISA 3200697178	Agriculture / Plant Tissue, Soil, Water Softening Systems, Boiler Feed Water, Drinking / Mineral Water, Biological Cultures, Dental / Clinical Analysis and Dairy / Food / Beverages Applications
$S_2O_3^{2-}, S^{2-}, I^-, Ag^+, Hg^{2+} = \text{Not acceptable}$ $SCN^- = 0.3, MnO_4^- = 0.1$ $Br = 0.03$ $NO_3^-, F^-, HCO_3^-, SO_4^{2-}, PO_4^{2-} = 1,000$	 <p>7660S 3200697411</p>	500-CL-IFS 3200697169	500-CL-SL 3200697168	500-CL-SH 3200697167	500-CL-ISA 3200697170	Agriculture, River / Tap Water, Plant Tissue, Soils, Boiler Feed Water, Clinical Analysis, Sweat, Urine, Cement, Plating Baths and Dairy / Food / Beverages Samples
Possible interference when multiply-charged ion (ex. Al^{3+}, Fe^{3+}) coexisted and foamed the complex.	 <p>7661S 3200693606</p>	500-F-IFS 3200697165	500-F-SL 3200697164	500-F-SH 3200697163	500-F-TISAB 3200697166	Dental / Toothpaste / Mouth Wash, Drinking / Seawater, Wastewater, Air / Stack Gases, Acids, Soils, Food, Biological Fluids, Plant Tissue, Coal, Carbonated Beverages and Bone
$ClO_4^-, I^- = \text{Not acceptable}, Br = 2$ $NO_2^- = 3, Cl^- = 300$ $HCO_3^-, H_2PO_4^-, SO_4^{2-} = \text{over } 1000$	 <p>7681S 3200697412</p>	500-NO3-IFS 3200697181	500-NO3-SL 3200697180	500-NO3-SH 3200697179	500-NO3-ISA 3200697182	Agriculture / Plant Tissue / Fertilizers, Surface / Seawater / Drinking Water, Sewage Effluent, Soils, Meats, Vegetables, Foods / Beverages
$Rb^+ = 0.4, Cs^+ = 3, NH_4^+ = 70$ $Li^+, Na^+, Mg^{2+}, Ca^{2+}, Sr^{2+}, Ba^{2+} = \text{over } 1,000$	 <p>7682S 3200697413</p>	500-K-IFS 3200697185	500-K-SL 3200697184	500-K-SH 3200697183	500-K-ISA 3200697186	Agriculture / Plant Tissue, Soils, Wastewater, River / Tap Water, Clinical Analysis, Saliva, Serum, Fertilizers, Soils and Wines, Dairy / Foods / Beverages

Note: Detailed information on standard solutions, ISAs, and filling solutions can be found on page 21



Metallic Electrode (For ORP Measurement)

Model	Operating Temperature Range (°C)	Electrode Material	Internal Solution	Applications
ORP Electrode 9300-10D Waterproof platinum 3-in-1 type  3014046710 Overall length: 150 mm Diameter of probe: 12 mm Connectors: BNC & phono jack	0-60	Pt / Glass	#300 (KCl)	Waterproof; Platinum on the flat tip allows measurement of small volume samples

Conductivity Cells (Submersible Type)

Model	Cell Constant	Measurement Range	Temp. Range (°C)	Cell Material	Thermistor	Minimum Sample Volume (ml)	Application
3551-10D  3014081712 Overall length: 175 mm Diameter of probe: 23 mm Connectors: BNC & phono jack	0.1 cm ⁻¹	0.1 μS/cm - 10 mS/cm	0 - 60	Pt-Pt black / Glass	Built-in	50	Low conductivity water (e.g., deionized, distilled)
	10 m ⁻¹	10 μS/m - 1 S/m					
3552-10D  3014081545 Overall length: 150 mm Diameter of probe: 12 mm Connectors: BNC & phono jack	1 cm ⁻¹	1 μS/cm - 100 mS/cm	0 - 100	Pt-Pt black / Glass	Built-in	15	General purpose use
	100 m ⁻¹	0.1 mS/m - 10 S/m					
3553-10D  3014081714 Overall length: 175 mm Width of probe: 28 mm Connectors: BNC & phono jack	10 cm ⁻¹	10 μS/cm - 1 S/cm	0 - 60	Pt-Pt black / Glass	Built-in	50	High conductivity water
	1000 m ⁻¹	1 mS/m - 100 S/m					
9382-10D  3014046709 Overall length: 150 mm Diameter of probe: 16 mm Connectors: BNC & phono jack	1 cm ⁻¹	1 μS/cm - 100 mS/cm	0 - 80	Ti-Pt black / Plastic	Built-in	20-30	General purpose use; Waterproof
	100 m ⁻¹	0.1 mS/m - 10 S/m					

Conductivity Cells (Flow Type)

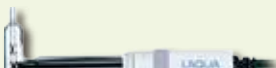
Model	Cell Constant	Measurement Range	Temp. Range (°C)	Cell Material	Thermistor	Minimum Sample Volume (ml)	Application
3561-10D  3014082350 Overall length: 143 mm Diameter of probe: 18 mm Connectors: BNC & phono jack	0.1 cm ⁻¹	0.1 μS/cm - 10 mS/cm	0 - 60	Pt-Pt black / Glass	Built-in	10	Low conductivity water (e.g., deionized, distilled)
	10 m ⁻¹	10 μS/m - 1 S/m					
3562-10D  3014082350 Overall length: 205 mm Diameter of probe: 18 mm Connectors: BNC & phono jack	1 cm ⁻¹	1 μS/cm - 100 mS/cm	0 - 60	Pt-Pt black / Glass	Built-in	16	General purpose use
	100 m ⁻¹	0.1 mS/m - 10 S/m					
3573-10C  3014082590 Overall length: 222 mm Diameter of probe: 18 mm Connector: BNC	10 cm ⁻¹	10 μS/cm - 1 S/cm	0 - 60	Pt-Pt black / Glass	—	4	High conductivity water
	1000 m ⁻¹	1 mS/m - 100 S/m					
3574-10C  3014082592 Overall length: 136 mm Diameter of probe: 66 mm Connector: BNC	10 cm ⁻¹	10 μS/cm - 100 mS/cm	0 - 60	Pt-Pt black / Glass	—	0.25	Small volume sample (e.g., column chromatography)
	1000 m ⁻¹	1 mS/m - 10 S/m					



501-S NIST pH Buffer Solution Kit



502-S USA pH Buffer Solution Kit



503-S Conductivity Standard Solution Kit



ORP Powders



220

250



230

Cleaning Solutions

pH Buffer Solution Kits

Code	Part No.	Description	Volume
501-S	3999960015	NIST pH Buffer Solution Kit (pH 4.01, 6.86, 9.18 buffers & 3.33M KCl)	250ml each
502-S	3999960016	USA pH Buffer Solution Kit (pH 4.01, 7.00, 10.01 buffers & 3.33M KCl)	250ml each

pH Buffer Solutions

Code	Part No.	Description	Volume
500-2	3999960028	pH 1.68 Buffer Solution at 25°C	500ml
500-4	3999960029	pH 4.01 Buffer Solution at 25°C	500ml
500-686	3999960030	pH 6.86 Buffer Solution at 25°C	500ml
500-7	3999960031	pH 7.00 Buffer Solution at 25°C	500ml
500-9	3999960032	pH 9.18 Buffer Solution at 25°C	500ml
500-10	3999960033	pH 10.01 Buffer Solution at 25°C	500ml
500-12	3999960034	pH 12.46 Buffer Solution at 25°C	500ml

Conductivity Standard Solution Kit

Code	Part No.	Description	Volume
503-S	3999960017	Conductivity Standard Solution Kit (84µS/cm, 1413µS/cm, 12.88mS/cm & 111.8mS/cm)	250ml each

Conductivity Standard Solutions

Code	Part No.	Description	Volume
500-21	3999960035	84 µS/cm Conductivity Standard Solution	500ml
500-22	3999960036	1413 µS/cm Conductivity Standard Solution	500ml
500-23	3999960037	12.88 mS/cm Conductivity Standard Solution	500ml
500-24	3999960038	111.8 mS/cm Conductivity Standard Solution	500ml

ORP Powders

Code	Part No.	Description	Volume
160-51	3200043618	89 mV at 25°C (for 250ml solution)	10 sachets/pack
160-22	3200043617	258 mV at 25°C (for 250ml solution)	10 sachets/pack

pH/ORP Electrode Filling Solutions

Code	Part No.	Description	Volume
525-3	3999960023	3.33M KCl	250ml
300	3200043640	3.33M KCl	250ml

pH Electrode Cleaning Solutions

Code	Part No.	Description	Volume
220	3014028653	For removing inorganic residues from glass membrane and liquid junction	2 x 50ml
230	3200530494	For removing inorganic and organic residues from glass membrane (30ml Solution A & 100ml Solution B)	30ml & 100ml
250	3200366771	For removing protein residues from glass membrane and liquid junction	400ml



Calcium Ion Electrode Solutions



Chloride Ion Electrode Solutions



Fluoride Ion Electrode Solutions



Potassium Ion Electrode Solutions



Ammonia Ion Electrode Solutions



Nitrate Ion Electrode Solutions

Ion Standard Solutions











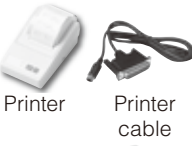

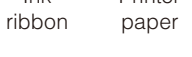



Code	Part No.	Description	Volume
500-NH4-SH	3200697171	1000 mg/L Ammonium Ion Standard Solution	500ml
500-NH4-SL	3200697172	100 mg/L Ammonium Ion Standard Solution	500ml
500-CA-SH	3200697175	1000 mg/L Calcium Ion Standard Solution	500ml
500-CA-SL	3200697176	100 mg/L Calcium Ion Standard Solution	500ml
500-CL-SH	3200697167	1000 mg/L Chloride Ion Standard Solution	500ml
500-CL-SL	3200697168	100 mg/L Chloride Ion Standard Solution	500ml
500-F-SH	3200697163	1000 mg/L Fluoride Ion Standard Solution	500ml
500-F-SL	3200697164	100 mg/L Fluoride Ion Standard Solution	500ml
500-NO3-SH	3200697179	1000 mg/L Nitrate Ion Standard Solution	500ml
500-NO3-SL	3200697180	100 mg/L Nitrate Ion Standard Solution	500ml
500-K-SH	3200697183	1000 mg/L Potassium Ion Standard Solution	500ml
500-K-SL	3200697184	100 mg/L Potassium Ion Standard Solution	500ml

Ionic Strength Adjustors

Code	Part No.	Description	Volume
500-NH3-ISA	3200697174	Ammonia Ionic Strength Adjustor 	500ml
500-CA-ISA	3200697178	Calcium Ionic Strength Adjustor	500ml
500-CL-ISA	3200697170	Chloride Ionic Strength Adjustor	500ml
500-F-TISAB	3200697166	Fluoride Ionic Strength Adjustor	500ml
500-NO3-ISA	3200697182	Nitrate Ionic Strength Adjustor	500ml
500-K-ISA	3200697186	Potassium Ionic Strength Adjustor	500ml

Ion Selective Electrode Filling Solutions

Code	Part No.	Description	Volume
500-NH3-IFS	3200697173	Ammonia Electrode Filling Solution	500ml
500-CA-IFS	3200697177	Calcium Electrode Filling solution	500ml
500-CL-IFS	3200697169	Chloride Electrode Filling Solution	500ml
500-F-IFS	3200697165	Fluoride Electrode Filling Solution	500ml
500-NO3-IFS	3200697181	Nitrate Electrode Filling Solution	500ml
500-K-IFS	3200697185	Potassium Electrode Filling Solution	500ml

Accessories		
Code	Part No.	Description
 LAQUA-SW-21CFR11	3200707161	21 CFR Part 11 Software includes CD with PIN code, USB cable, and manual
	3014030147 (230v) 3014030146 (120v)	Printer (for GLP/GMP compliance) Cable sold separately, Plain paper
	3014030148	Printer cable (1.5 m)
	3014030149	Printer paper (20 rolls)
	3014030150	Ink ribbon (5 pcs/set)
	3200647413	Multi-Voltage (100-240V) with 6 plugs, (US, UK, EU, ANZ, Korea and China) 1.8 m cable
	3014028368	Digital simulator X-51 (pH, mV, Ion, DO, temperature simulator)
	3014028370	Digital simulator X-52 (Conductivity, temperature simulator)
	3200382462	LCD protection sheet (2 pcs/pack)
	3200382441	Protection cover (Protects the meter for F-70, DS-70, 1000 series)
	3200373941	USB cable (to connect meter and PC.)
	3014030152	Analog cable (Analog (alarm) output cable)
	3014030151	Serial cable (to connect meter and PC (Serial, 9 pins))
FA-70S	3200382557	Adjustable, free-standing electrode stand (Height: 384 mm) <i>image on the right</i>
FA-70L	3200382560	Long, free-standing electrode stand (Height: 450-650mm) <i>image on the right</i>
	3200373991	Arm for electrode stand FA-70A, FA-70S, & FA-70L
	3200373961	Electrode holders, 2pcs (for mounting electrode with round cap on electrode stand arm)
	3200382477	Electrode protection caps, 3pcs (for 9615S-10D, 9618S-10D, 9681S-10D pH electrode)
	3200043508	Electrode protection caps, 5pcs (for 9621-10D, 9625-10D, 9630-10D, 9631-10D, 9632-10D, 6367-10D, 6377-10D, 6252-10D, 6261-10C, 1066A-10C, 1076-10C, 2060-10T, 9300-10D, 9382-10D, 3552-10D pH electrode)
	3200382482	Electrode protection cap for long electrode (for 9680S-10D, 9480-10C pH Electrode)

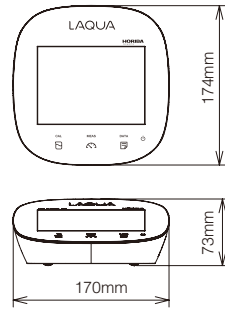

Body • Standard Electrode Stand

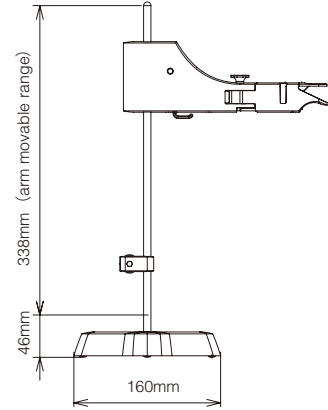

Long Type Electrode Stand

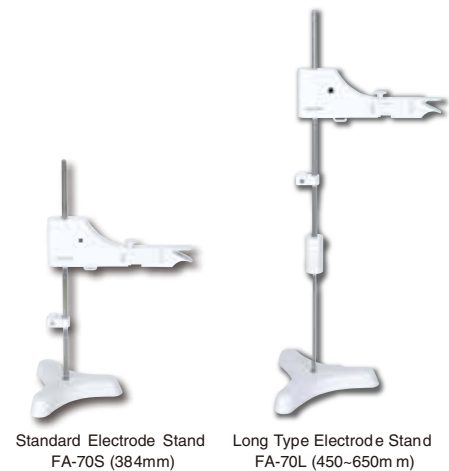
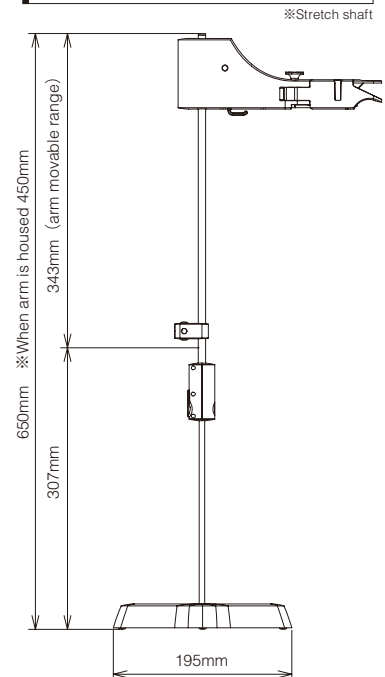

With over 60 years of engineering excellence, HORIBA's diverse range of water quality analyzers and electrodes are ideal for everyday laboratory needs through to the most demanding of applications. Visit our website for a wealth of useful information and water quality measurement tips to help you obtain the best results in your work.



Benchtop Meters

Developed using extensive feedback from users, our new LAQUA meters deliver the best solution for water quality analysis. Our LAQUA website features an online 'Selection Guide' to enable you to find the perfect LAQUA meter and electrode for your need.



Handheld Meters

In the lab, in the field or anywhere you need it. LAQUA Handheld meters are designed for use with one hand and with an IP67 waterproof rating and shock-resistant casing. Meters can be used for long periods, even in dark places, making it ideal for field measurements in rivers and lakes.



Electrodes

Various electrodes to match any application. A wide range of products for both benchtop and portable systems are available, including easy and reliable standard models, application-focused models for small samples or large containers, and special electrodes for specific sample characteristics.



Pocket Meters

Analyzing water quality is simplified when using our LAQUAtwin range of meters. Designed to produce accurate and reliable results. Anyone, anywhere, at any time can measure samples easily with a LAQUAtwin meter. See just how good they are at our website.



Application Notes

LAQUAtwin pocket meters offer quick and convenient alternative to analyze important parameters with high accuracy. Several application notes are available at (<http://goo.gl/znwE6j>) detailing the use of LAQUAtwin and the results achieved for the respective applications. Additional application notes will be added when available.



- The contents of this catalog are subject to change without prior notice, and without any subsequent liability to this company.
- The color of the actual products may differ from the color pictured in this catalog due to printing limitations.
- It is strictly forbidden to copy the content of this catalog in part or in full.
- All brand names, product names and service names in this catalog are trademarks or registered trademarks of their respective companies.
- Windows is a registered trademark of Microsoft Corporation in the United States and other countries.

HORIBA Instruments (Singapore) Pte. Ltd.
 83 Science Park Drive, #02-02A,
 The Curie, Singapore 118258
 Phone: 65 6908-9660
 Fax: 65 6745-8155
 e-mail: laqua@horiba.com
www.horiba-laqua.com

HORIBA UK Limited
 Kyoto Close, Moulton Park,
 Northampton NN3 6FL
 Phone: 44 (0) 1604 542567
 Fax: 44 (0) 1604 542699
 e-mail: waterquality@horiba.com
www.horiba.com/uk

