

# LAQUA

LAQUA WQ-300 Series Smart Handheld Water Quality Meters



pH | ORP | Dissolved Oxygen | Conductivity | Resistivity | Total Dissolved Solids | Salinity | Ion



[www.horiba-laqua.com](http://www.horiba-laqua.com)



# LAQUA WQ-300 Series

Smart Handheld Water Quality Meters



Meter and electrode shown in actual size



Scan code to view LAQUA WQ-300 Series feature video online



Visit the **HORIBA LAQUA Singapore** Channel on YouTube and subscribe to see more of our videos.





### Large Colour Graphic LCD Screen with Backlight

All models have colour graphic digital LCD screen (70 x 52 mm) with white LED backlight for easy viewing.



### Built-in Foldable Meter Stand

Collapsible meter stand is built-in at the back of the meter for convenient usage and storage.



### IP67 Waterproof and Dustproof

Fully protected from dust and capable of withstanding water immersion up to 1 meter depth for 30 mins.



### Battery and USB Powered

Four AA batteries or battery pack with micro USB cable can be used to power the meter in the field. USB charger plugged to a power outlet can be used for an uninterrupted operation in the lab.



### Eco-friendly, Shock-proof, Scratch Resistant, and Non-slip

Apart from their high impact strength, the polycarbonate and TPE materials are also long-lasting and recyclable. The TPE provides non-slip grip and is not easily damaged by abrasion.



### Built-in Sensor Holders

Three grooves on the meter housing serve as sensor holders.



# LAQUA WQ-300 Series

## Smart Handheld Water Quality Meters



10 m extension cable



### No Sensor Adapter Needed

Each sensor head has two grooves and one hook which can be used to attach up to three sensor heads.



### Efficient Sensor Locking Mechanism

The push-pull connectors deliver a simple yet fast and strong method to connect and disconnect sensors. The lock is released only when the outer sleeve of the connector is pulled back so accidental disconnection is prevented.

### Sensor's LED Light as Reading Stability Indicator

Blue LED light on the sensor head flashes until the reading is stable.

### Compatible with Conventional Electrodes having BNC and Phono Connectors and Long Cables

With 300-BNC sensor head adapter, conventional electrodes with BNC and phono connectors can be connected to the meter. Also, electrodes with up to 15m cable can be used without noise problem. 300-EXT-10, a 10 m extension cable, is available.



### Hands-free Testing

Hang the meter using a wrist strap or lanyard, place it into the carrying case, or mount it to a wall while in use.

### Ergonomic Design

The black meter housing is made of polycarbonate material covered with a layer of thermoplastic elastomer (TPE) material. It is lightweight, comfortable to touch, and suitable for field applications.



## Rugged Carrying Case

Keeps all your equipment organized and secure.

### Storage Space

Compartment for instruction manual and accessories.

### DO Sensor Guard



### Bottle Stand

Secures the bottles upright while doing calibration.



### Bottle Holders

Stores up to 8 x 60ml bottles of Standard Solutions

### Cable Space

For sensors with extra long cables

### Cable Winder

Organize sensor cables neatly.

### Sensor Holders

Holds pH, Conductivity, and DO sensors

English  
日本語  
Français  
Deutsch  
Español  
Português  
中文



## Multi-Language Options

Available in several languages—English, Japanese, French, German, Spanish, Portuguese, and Chinese.



## Simultaneous Calibrations and Measurements

Applicable for dual- and triple-channel models.

# LAQUA WQ-300 Series | Smart Handheld Water Quality Meters

## Versatile Channels & Adaptive Display

Single-, dual-, and triple-channel models are available. Sensors can be connected to any channel in dual- and triple-channel models and the meter screen automatically adjusts.

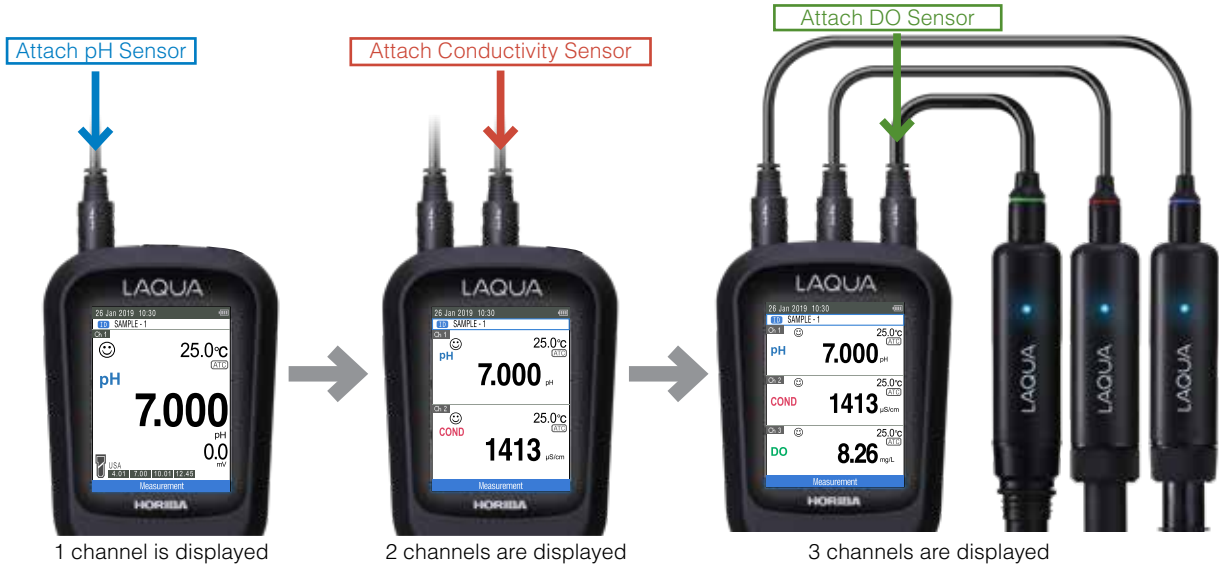

## Automatic Sensor Recognition

Sensor info, calibration data, and measurement setup stored in sensor head are viewable in the meter when sensor is connected.

26 Jan 2019 10:30	
SAMPLE - 1	
Ch 1	25.0°C (ATC)
pH	
7.000	
pH	0.0 mV
Measurement	



26 Jan 2019 10:30	
pH Setup	
pH Resolution	0.01 ▶
Buffer Group	USA ▶
CAL Alarm	OFF ▶
Temp. Type	ATC ▶
CAL Data Clear	▶
Set	

26 Jan 2019 10:30					
Ch1 Calibration Data					
Ch 1 Latest CAL Date	:29 Aug 2019				
Sensor Status	: Excellent				
Ave. Slope	: 97.8%				
Offset	: -1.9mV				
USA					
4.01 7.00 10.01					
P	Date Time	Cal Value	mV	°C	%
1	29 Aug 2019 14:55	4.00	168.8	23.4	96.9
2	29 Aug 2019 14:53	7.00	-2.1	23.6	98.7
3	29 Aug 2019 14:56	10.03	-177.6	23.3	
4					
5					
Measurement					

26 Jan 2019 10:30	
Ch1 Sensor Info.	
Sensor	
Model	: 300pH - 2
SN	: ABCD1234
SW Ver.:	0.3.6
Cartridge	
Model	: 300-P-C
SN	: 123456
Set	





## Data Transfer via USB or Wireless Communication

Meter stores up to 10,000 data with date/time stamp. Transfer data from meter to computer seamlessly via USB cable or wirelessly via Wi-Fi. Each meter comes with a wireless SD card.

Scan code to view LAQUA WQ-300 Series USB Data Transfer video



Scan code to view LAQUA WQ-300 Series Wireless Data Transfer video



## Printer Communication

Print data using a printer via 25-pin D-sub printer cable.

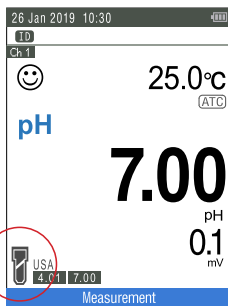

## Sensor Status Indicator

Sensor icon presents the sensor condition after calibration.



Excellent



Very Good



Good



Temperature sensor is connected to meter

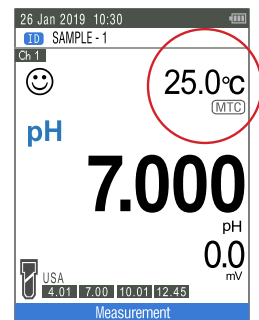

Temperature sensor is not connected to meter

## Temperature Sensor Indicator

## Sample ID

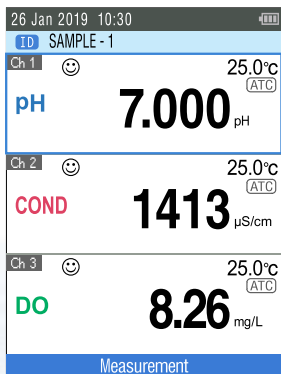

Use up to eight characters for creating Sample ID.

## Calibration Data

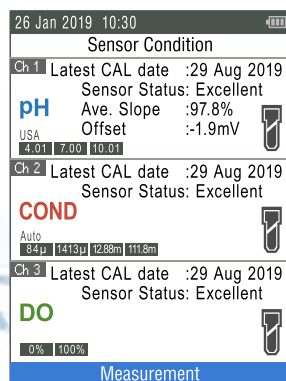

Right arrow button shows the latest calibration data.

## Measurement Modes

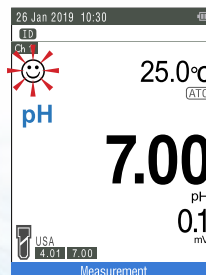

Auto Stable

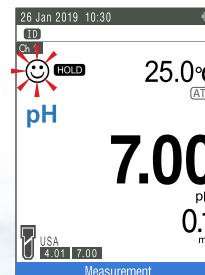

Auto Hold

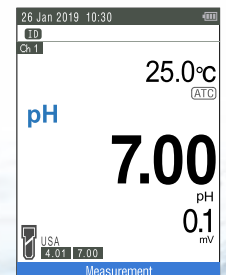

Real Time



# LAQUA WQ-300 Series | Smart Handheld Water Quality Meters

## Customizable Meter Kit

Create a custom meter kit by selecting the meter, sensor, and accessories.

DO COND pH  
Multi-parameter combinations



pH pH pH  
Single parameter combinations



Up to 55 possible meter + sensor combinations

## 5 Combinations

**WQ-310**  
Single Channel



## 15 Combinations

**WQ-320**  
Dual Channel



## 35 Combinations

**WQ-330**  
Triple Channel

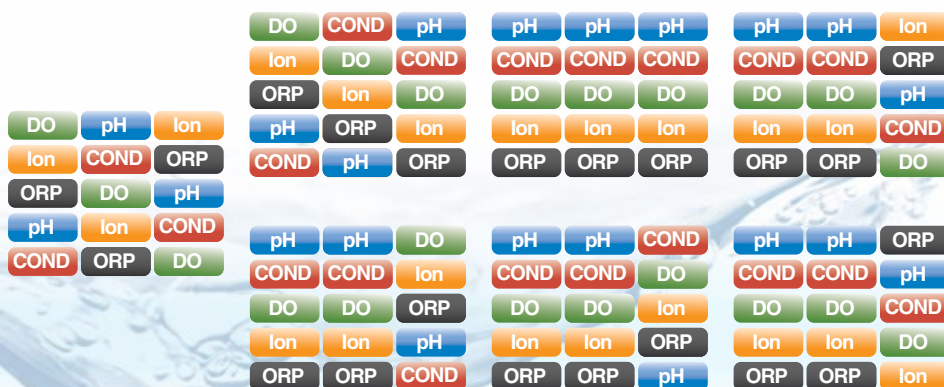



Choose your meter\*:  
Meter only

Choose your sensor kit:



\*Includes carrying case, 4 x AA batteries, wireless SD card, user manual, and quick guide

**WQ-310-K**  
Single Channel  
3200832605



**WQ-320-K**  
Dual Channel  
3200832606



**WQ-330-K**  
Triple Channel  
3200832607



Sensor (2.0m cable) kit

Sensor (5.0m cable) kit

**WQ 300 PH Kit 2M**

**pH** pH Sensor Kit with USA pH Buffers - 4000043090  
pH Sensor Kit with NIST pH Buffers - 4000043092

pH Sensor Cartridge

pH Sensor Head 2M

4.01, 7.00, 10.01 USA pH Buffers (60ml each)

**WQ 300 PH Kit 5M**

**pH** pH Sensor Kit with USA pH Buffers - 4000043091  
pH Sensor Kit with NIST pH Buffers - 4000043093

pH Sensor Cartridge

pH Sensor Head 5M

4.01, 7.00, 10.01 USA pH Buffers (60ml each)

**WQ 300 4-Cell EC Kit 2M**

**COND** 4-Cell Conductivity Sensor Kit with Conductivity Standards - 4000043094

4-cell Conductivity Sensor Cartridge

EC Sensor Head 2M

84µS/cm, 1413µS/cm, 12.88mS/cm, & 111.8 mS/cm Conductivity Standards (60ml each)

**WQ 300 4-Cell EC Kit 5M**

**COND** 4-Cell Conductivity Sensor Kit with Conductivity Standards - 4000043095

4-cell Conductivity Sensor Cartridge

EC Sensor Head 5M

84µS/cm, 1413µS/cm, 12.88mS/cm, & 111.8 mS/cm Conductivity Standards (60ml each)

**WQ 300 2-Cell EC Kit 2M**

**COND** 2-Cell Conductivity Sensor Kit with Conductivity Standards - 4000046656

2-cell Conductivity Sensor Cartridge

EC Sensor Head 2M

84µS/cm, 1413µS/cm, 12.88mS/cm, & 111.8 mS/cm Conductivity Standards (60ml each)

**WQ 300 2-Cell EC Kit 5M**

**COND** 2-Cell Conductivity Sensor Kit with Conductivity Standards - 4000046657

2-cell Conductivity Sensor Cartridge

EC Sensor Head 5M

84µS/cm, 1413µS/cm, 12.88mS/cm, & 111.8 mS/cm Conductivity Standards (60ml each)

**WQ 300 2-Cell EC Flow Cell Kit 2M**

**COND** 2-Cell Conductivity Sensor Kit with Flow-Cell and Conductivity Standards - 4000046674

2-cell Conductivity Sensor Cartridge

Flow Cell

EC Sensor Head 2M

84µS/cm, 1413µS/cm, 12.88mS/cm, & 111.8 mS/cm Conductivity Standards (60ml each)

**WQ 300 2-Cell EC Flow Cell Kit 5M**

**COND** 2-Cell Conductivity Sensor Kit with Flow-Cell and Conductivity Standards - 4000046675

2-cell Conductivity Sensor Cartridge

Flow Cell

EC Sensor Head 5M

84µS/cm, 1413µS/cm, 12.88mS/cm, & 111.8 mS/cm Conductivity Standards (60ml each)

**WQ 300 DO Kit 2M**

**DO** DO Sensor - 3200780940

Stainless Steel DO Sensor Protective Guard

Optical DO Sensor with membrane cap 2M

Calibration Bottle

**WQ 300 DO Kit 5M**

**DO** DO Sensor - 3200780942

Stainless Steel DO Sensor Protective Guard

Optical DO Sensor with membrane cap 5M

Calibration Bottle

**WQ 300 ION Kit 2M**

**Ion** Ion Sensor Kit - 4000043097

Sensor Head Adapter

Ion Selective Electrode (sold separately)

Ion Sensor Head 2M

**WQ 300 ION Kit 5M**

**Ion** Ion Sensor Kit - 4000053876

Sensor Head Adapter

Ion Selective Electrode (sold separately)

Ion Sensor Head 5M

**WQ 300 ORP Kit 2M**

**ORP** ORP Sensor Kit - 4000043096

ORP Sensor Cartridge

ORP Sensor Head 2M

3 x 560-225 ORP Solution (60ml)

**WQ 300 ORP Kit 5M**

**ORP** ORP Sensor Kit - 4000053875

ORP Sensor Cartridge

ORP Sensor Head 5M

3 x 560-225 ORP Solution (60ml)

\*10m extension cable available to achieve a maximum cable length of 15m



**Sensor head with built-in digital circuit**

Retains sensor and measurement information

**Sensor cartridge**

Replaceable, cost efficient and environment-friendly

Smart Digital Sensor



# HORIBA's Smart digital sensor technology

All sensor heads are offered in 2-m and 5-m cable versions. A 10-m extension cable is also available.

## ■ Maintenance-free, gel-filled pH sensor

No electrolyte refilling required

- KCl gel electrolyte
- Double junction reference
- Porous sintered polyethylene junction
- Built-in temperature sensor
- Rugged polycarbonate body
- Replaceable pH sensor cartridge



## ■ 2-Cell & 4-Cell conductivity sensors

Wide range of conductivity measurements possible

- 2-Cell conductivity sensor with flow cell is designed for ultra-pure water applications
- From clean water to industrial wastewater, the 4-cell type can measure a variety of samples with different conductivities
- Built-in temperature sensor
- Stainless steel 2-cell cartridge
- Durable epoxy / carbon body 4-cell cartridge
- Replaceable conductivity sensor cartridge

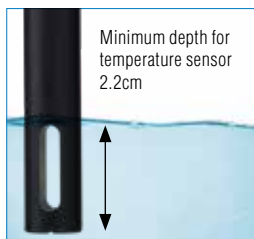

## ■ Optical dissolved oxygen (DO) sensor

Longer usable life with excellent performance

- Easy to handle – not affected with sample flow velocity, not sensitive to hydrogen sulfide, DO sensor cap replacement after 1-2 years\*
- Built-in temperature sensor
- Comes with replaceable DO sensor cap, air calibration bottle and Stainless Steel DO Sensor Protective Guard

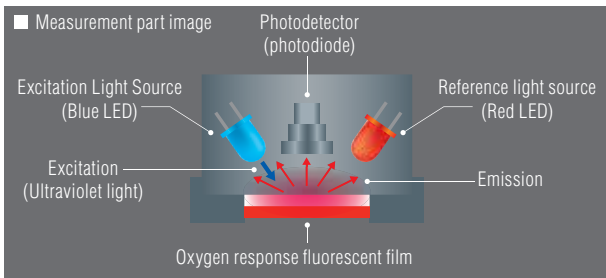

## ■ Maintenance-free, gel-filled ORP sensor

No electrolyte refilling required

- Platinum tip attached to glass
- KCl gel electrolyte
- Porous sintered polyethylene junction
- Built-in temperature sensor
- Rugged polycarbonate body
- Replaceable ORP sensor cartridge

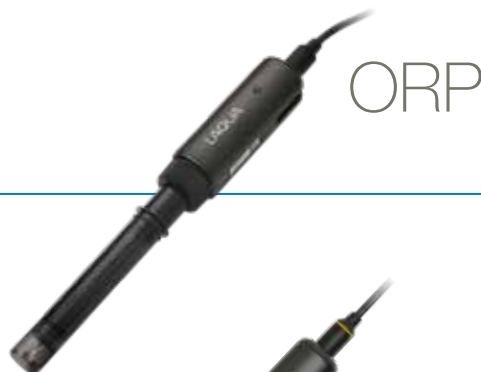

## ■ Ion sensor head

Compatible with conventional ion selective electrodes

- Accepts all combination ion selective electrodes with BNC connector
- Requires sensor head adapter



\*Depending on application, handling, and maintenance



# LAQUA WQ-300 Series | Smart Handheld Water Quality Meters

## Sensor and Meter Specifications

pH Sensor Head pH / mV / Temp (°C/°F)		
Model	300PH-2	300PH-5
Part No.	3200812206	3200812207
pH Range	-2.00 to 20.00 pH -2.000 to 20.000 pH	
Resolution	-2.00 to 20.00: 0.01 pH -2.000 to 20.000: 0.001 pH	
Accuracy	-2.00 to 20.00: ±0.01 -2.000 to 20.000: ±0.005	
Calibration Points	Up to 6	
pH Buffer Groups	USA, DIN, NIST, NIST10, Custom	
mV Range	±1000.0 mV	
Resolution	0.1 mV	
Accuracy	±0.1 mV	
Temperature Range	-30.0 to 130.0 °C -22.0 to 266.0 °F	
Resolution	0.1 °C / °F	
Accuracy	±0.5 °C / ±0.9 °F	
Calibration Option	Yes	
Body Material	ABS / Polycarbonate	
Length and Diameter	85 x 30 mm	
Connector	Push-pull	
Cable Length	2 m	5 m

pH Sensor Cartridge pH/mV/Temp (°C/°F)	
Model	300-P-C
Part No.	3200786363
pH Range	-2.00 to 20.00 pH -2.000 to 20.000 pH
Operating Temperature Range	0 to 80 °C -32.0 to 176.0 °F
Junction Material	Porous sintered polyethylene
Double Junction	Yes
Temperature Sensor	Built-in
Length and Diameter	110 x 16 mm
Body Material	Polycarbonate, glass bulb

Dissolved Oxygen Sensor DO (mg/L, %) / O <sub>2</sub> / Temp (°C/°F)		
Model	300-D-2	300-D-5
Part No.	3200780940	3200780942
Dissolved Oxygen (DO) Range	0.00 to 20.00 mg/L 0.0 to 200.0 %	
Resolution	0.01 mg/L, 0.1%	
Accuracy	±0.2 mg/L, ±2 %	
Salinity Compensation	Auto: by conductivity sensor / Manual: 0.0 to 40.0 ppt	
Barometric Pressure Compensation	Auto: by built-in barometer / Manual: 10.0 to 199.9 kPa	
Calibration Points	Up to 2	
Oxygen Range	0.0 to 50.0%	
Resolution	0.1%	
Accuracy	±0.5%	
Temperature Range	-30.0 to 130.0 °C -22.0 to 266.0 °F	
Resolution	0.1 °C / °F	
Accuracy	±0.5 °C / ±0.9 °F	
Calibration Option	Yes	
Body Material	ABS / Polycarbonate	
Length and Diameter	200 x 16 mm	
Connector	Push-pull	
Cable Length	2 m	5 m
Sensor cap included	1	

Dissolved Oxygen Sensor Cap	
Model	300-D-M
Part No.	3200781554
DO Range	0.00 to 20.00 mg/L 0.0 to 200.0 %
Operating Temperature Range	0 to 50.0 °C 32.0 to 122.0 °F
Length and Diameter	10 x 16 mm
Body Material	PVC, PMMA

Conductivity Sensor Head EC / Sal / TDS / Res / Temp (°C/°F)		
Model	300-C-2	300-C-5
Part No.	3200784468	3200812202
Conductivity Range	μS/cm	μS/m
	0.000 to 0.199	0.0 to 19.9
	0.200 to 1.999	20.0 to 199.9
	2.00 to 19.99	200 to 1999
	20.0 to 199.9	mS/m
	200 to 1999	2.00 to 19.99
	mS/cm	20.0 to 199.9
	2.00 to 19.99	200 to 1999
	20.0 to 199.9	S/m
	200 to 2000	2.00 to 19.99
200 to 2000	20.0 to 200.0	
Resolution	Auto ranging, up to 4 significant digits	
Accuracy	± 0.5% full scale of each range > 200 mS/cm (20.0 S/m): ± 1.5% full scale	
Reference Temperature	15 to 30 °C	
Temperature Coefficient	0.00 to 10.00 %/°C	
Calibration Points	Up to 4 (Auto) / Up to 5 (Manual)	
Units	S/cm, S/m	
Salinity Range	0.00 to 80.00 ppt 0.000 to 8.000 %	
Resolution	0.01 ppt, 0.001 %	
Accuracy	± 0.5% of reading or ± 0.01 ppt, whichever is greater	
Salinity Curves	NaCl, Seawater (UNESCO 1978)	
Calibration Option	Yes	
Total Dissolved Solids (TDS) Range	0.01 mg/L to 200,000 mg/L	
Resolution	0.01 minimum, 4 significant digits	
Accuracy	± 0.5% of reading or ± 0.1 mg/L, whichever is greater	
TDS Curves	Linear (0.40 to 1.00), EN27888, 442, NaCl	
Resistivity Range	Ω•cm	Ω•m
	0.1 to 199.9	0.001 to 1.999
	200 to 1999	2.00 to 19.99
	kΩ•cm	20.0 to 199.9
	2.00 to 19.99	200 to 1999
	20.0 to 199.9	kΩ•m
	200 to 1999	2.00 to 19.99
	MΩ•cm	20.0 to 199.9
	2.00 to 19.99	200 to 2000
	20.0 to 200.0	
Resolution	Auto ranging, up to 4 significant digits	
Accuracy	± 0.5% full scale of each range > 200 mS/cm (20.0 S/m): ± 1.5% full scale	
Temperature Range	-30.0 to 130.0 °C -22.0 to 266.0 °F	
Resolution	0.1 °C / °F	
Accuracy	±0.5 °C / ±0.9 °F	
Calibration Option	Yes	
Body Material	ABS / Polycarbonate	
Length and Diameter	85 x 30 mm	
Connector	Push-pull	
Cable Length	2 m	5 m

4-Cell Conductivity Sensor Cartridge	
Model	300-4C-C
Part No.	3200780928
Cell Constant	0.172 cm <sup>-1</sup>
Conductivity Range	10 μS/cm to 2000 mS/cm
Operating Temperature Range	0 to 100 °C 32.0 to 212.0 °F
Temperature Sensor	Built-in
Length and Diameter	110 x 16 mm
Body Material	Epoxy, carbon

2-Cell Conductivity Sensor Cartridge	
Model	300-2C-C
Part No.	3200820579
Cell Constant	0.1 cm <sup>-1</sup>
Conductivity Range	0.01 μS/cm to 500 μS/cm
Temperature Range	0 to 100 °C 32.0 to 212.0 °F
Temperature Sensor	Built-in
Length and Diameter	110 x 16 mm
Body Material	Stainless steel

Ion Sensor Head Ion / mV / Temp (°C/°F)		
Model	300-I-2	300-I-5
Part No.	3200812203	3200923560
Ion Range	(mg/L, mmol/L) 0.000 to 0.999, 1.00 to 9.99, 10.0 to 99.9, 100 to 999, 1000 to 9990, 10000 to 99900	
Resolution	0.001 minimum, 3 significant digits	
Accuracy	±0.3% full scale	
Calibration Points	Up to 5	
mV Range	±1000.0 mV	
Resolution	0.1 mV	
Accuracy	±0.1 mV	
Temperature Range	-30.0 to 130.0 °C -22.0 to 266.0 °F	
Resolution	0.1 °C / °F	
Accuracy	±0.5 °C / ±0.9 °F	
Calibration Option	Yes	
Body Material	ABS / Polycarbonate	
Length and Diameter	85 x 30 mm	
Connector	Push-pull	
Cable Length	2 m	5 m

ORP Sensor Head ORP / Temp (°C/°F)		
Model	300-O-2	300-O-5
Part No.	3200812204	3200923561
ORP Range	-2000 to +2000 mV	
Resolution	< ±1000.0 mV: 0.1mV ≥ 1000.0 mV: 1 mV	
Accuracy	< ±1000.0 mV: ±0.1 mV ≥ 1000.0 mV: ±1 mV	
Calibration Option	Yes	
Temperature Range	-30.0 to 130.0 °C -22.0 to 266.0 °F	
Resolution	0.1 °C / °F	
Accuracy	±0.5 °C / ±0.9 °F	
Calibration Option	Yes	
Body Material	ABS / Polycarbonate	
Length and Diameter	85 x 30 mm	
Connector	Push-pull	
Cable Length	2 m	5 m

ORP Sensor Cartridge ORP / Temp (°C/°F)	
Model	300-O-C
Part No.	3200922104
ORP Range	-2000 to +2000 mV
Temperature Range	0 to 80 °C -32.0 to 176.0 °F
Junction Material	Porous sintered polyethylene
Double Junction	Yes
Temperature Sensor	Built-in
Length and Diameter	110 x 16 mm
Body Material	Polycarbonate, platinum/glass

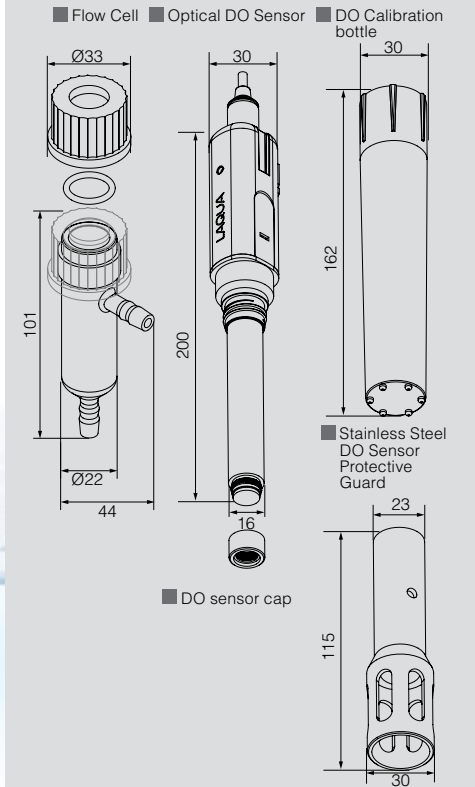
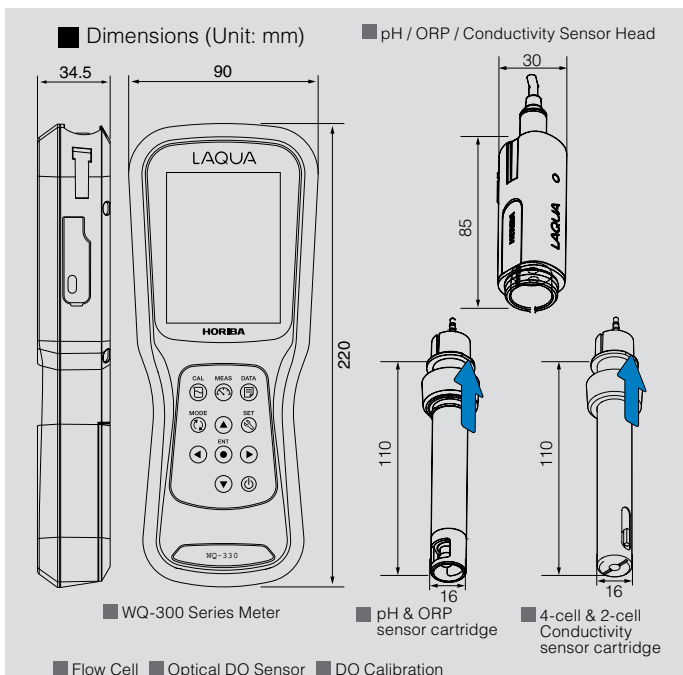

Model	WQ-310-K	WQ-320-K	WQ-330-K
Part No.	3200832605	3200832606	3200832607
Channel	Single	Dual	Triple
Memory	10,000 Data with date and time stamp		
Data Log	Auto / Manual		
Measurement Modes	Auto Stable / Auto Hold / Real Time		
Calibration Alarm	Programmable: 0 to 400 days		
Auto Power Off	Programmable: 0 to 60 minutes		
Real-time Clock	Available		
Sensor Status	On display		
Diagnostics	Error codes		
Language	English, Japanese, French, German, Spanish, Portuguese, Chinese		
PC Communication	Via micro USB cable or wireless		
Printer Communication	Via 25-pin D-sub printer (RS232) cable		
Meter Input	Push-pull connector		
Display	Color graphic TFT-LCD, 3.5 inches		
Housing	IP67, shock & scratch resistant, non-slip (ABS / polycarbonate)		
Power Requirement	4 x AA batteries / battery pack or USB charger with micro USB cable		
Battery Life	> 100 hours (with display brightness 3 and no sensor connected)		
Dimensions	220 (L) x 90 (W) x 34 (H) mm		
Weight	Approx. 400g (batteries included), 320 g (batteries excluded)		
Standard Accessories	Carrying case, 4 x AA batteries, wireless SD card, manual, and quick guide		

# LAQUA WQ-300 Series | Smart Handheld Water Quality Meters

## Accessories & Solutions

### pH Buffers

Part No.	Model	Description
3999960015	501-S	NIST pH Buffers Kit (pH 4.01, 6.86, 9.18 buffers & 3.33M KCl, 250ml each)
3999960016	502-S	USA pH Buffers Kit (pH 4.01, 7.00, 10.01 buffers & 3.33M KCl, 250ml each)
3999960028	500-2	pH 1.68 Buffer at 25°C, 500ml
3999960029	500-4	pH 4.01 Buffer at 25°C, 500ml
3999960030	500-686	pH 6.86 Buffer at 25°C, 500ml
3999960031	500-7	pH 7.00 Buffer at 25°C, 500ml
3999960032	500-9	pH 9.18 Buffer at 25°C, 500ml
3999960033	500-10	pH 10.01 Buffer at 25°C, 500ml
3999960034	500-12	pH 12.46 Buffer at 25°C, 500ml





NIST pH Buffers Kit 501-S



USA pH Buffers Kit 502-S

### ORP Standard Solution & Powders

Part No.	Model	Description
4000047848	500-225	ORP Standard Solution 225 mV at 25°C (500ml)
3200043618	160-51	89 mV at 25°C for 250ml (10 sachets/pack) 
3200043617	160-22	258 mV at 25°C for 250ml (10 sachets/pack) 



ORP Standard Solution 225 mV



ORP Powders

### Conductivity Standards

Part No.	Model	Description
3999960017	503-S	Conductivity Standards Kit (84µS/cm, 1413µS/cm, 12.88mS/cm & 111.8mS/cm, 250ml each)
3999960035	500-21	84µS/cm Conductivity Standard at 25°C, 500ml
3999960036	500-22	1413µS/cm Conductivity Standard at 25°C, 500ml
3999960037	500-23	12.88mS/cm Conductivity Standard at 25°C, 500ml
3999960038	500-24	111.8mS/cm Conductivity Standard at 25°C, 500ml



Conductivity Standards Kit 503-S

### Ion Standard Solutions

Part No.	Model	Description
3200697172	500-NH4-SL	100 mg/L Ammonium Ion Standard Solution
3200697171	500-NH4-SH	1000 mg/L Ammonium Ion Standard Solution
3200697176	500-CA-SL	100 mg/L Calcium Ion Standard Solution
3200697175	500-CA-SH	1000 mg/L Calcium Ion Standard Solution
3200697168	500-CL-SL	100 mg/L Chloride Ion Standard Solution
3200697167	500-CL-SH	1000 mg/L Chloride Ion Standard Solution
3200697164	500-F-SL	100 mg/L Fluoride Ion Standard Solution
3200697163	500-F-SH	1000 mg/L Fluoride Ion Standard Solution
3200697180	500-NO3-SL	100 mg/L Nitrate Ion Standard Solution
3200697179	500-NO3-SH	1000 mg/L Nitrate Ion Standard Solution
3200697180	500-K-SL	100 mg/L Potassium Ion Standard Solution
3200697179	500-K-SH	1000 mg/L Potassium Ion Standard Solution



Calcium Ion Electrode Solutions



Chloride Ion Electrode Solutions



Fluoride Ion Electrode Solutions



Potassium Ion Electrode Solutions



Ammonia Ion Electrode Solutions



Nitrate Ion Electrode Solutions

### Ionic Strength Adjustors

3200697174	500-NH3-ISA	Ammonia Ionic Strength Adjustor 
3200697178	500-CA-ISA	Calcium Ionic Strength Adjustor
3200697170	500-CL-ISA	Chloride Ionic Strength Adjustor
3200697166	500-F-TISAB	Fluoride Ionic Strength Adjustor
3200697182	500-NO3-ISA	Nitrate Ionic Strength Adjustor
3200697182	500-K-ISA	Potassium Ionic Strength Adjustor

### Ion Selective Electrode Filling Solutions

3200697173	500-NH3-IFS	Ammonia Electrode Filling Solution
3200697177	500-CA-IFS	Calcium Electrode Filling Solution
3200697169	500-CL-IFS	Chloride Electrode Filling Solution
3200697165	500-F-IFS	Fluoride Electrode Filling Solution
3200697181	500-NO3-IFS	Nitrate Electrode Filling Solution
3200697181	500-K-IFS	Potassium Electrode Filling Solution



## Cleaning Solutions

Part No.	Model	Description
3014028653	220	Cleaning solution for removing inorganic sample residues, 50ml x 2pcs
3200530494	230	Cleaning solution for removing inorganic and organic sample residues, Solution A (30ml) & Solution B (100ml)
3200366771	250	Cleaning solution for removing proteins, 400ml



220 250

## Sensors, Cartridges, and Tips

Part No.	Model	Description
3200786363	300-P-C	pH sensor cartridge
3200922104	300-O-C	ORP sensor cartridge
3200780928	300-4C-C	4-cell conductivity sensor cartridge
3200820579	300-2C-C	2-cell conductivity sensor cartridge
3200781554	300-D-M	Optical DO sensor cap
3014046710	9300-10D	ORP electrode with flat platinum tip and temperature sensor
3200698386	5002S-10C	Ammonia electrode (combination)
3200697410	6583S-10C	Calcium ion selective electrode (combination)
3200697407	6560S-10C	Chloride ion selective electrode (combination)
3200693774	6561S-10C	Fluoride ion electrode (combination)
3200697408	6581S-10C	Nitrate ion selective electrode (combination)
3200697409	6582S-10C	Potassium ion selective electrode (combination)
3200705774	-	Ammonia electrode membrane caps (3 pcs.)
3200697414	7683S	Calcium electrode tip
3200697411	7660S	Chloride electrode tip
3200693606	7661S	Fluoride electrode tip
3200697412	7681S	Nitrate electrode tip
3200697413	7682S	Potassium electrode tip



230

Cleaning Solutions



Ammonia electrode membrane caps



Calcium electrode tip



Chloride electrode tip



Fluoride electrode tip



Nitrate electrode tip



Potassium electrode tip

## Accessories

Part No.	Model	Description
3200844642	—	Flow Cell (for 300-2C-C)
3200821465	300-BNC	pH/ORP/Ion sensor head adapter
3200921588	300-EXT-10	10-m sensor head extension cable
3014028368	X-51	Digital simulator (300-BNC is required for pH, ORP, and Ion sensor heads)
3014030146	—	Printer for GLP / GMP compliance, 120V US version (printer cable is sold separately)
3014030147	—	Printer for GLP / GMP compliance, 230V EU version (printer cable is sold separately)
3200779638	—	25-pin D-sub printer (RS232) cable, 1.5m
3014030149	—	Printer paper, 20 rolls
3014030150	—	Printer ink ribbon, 5pcs/pack
3200828646	—	Black pH sensor tip guard (for 200 series, 300 series), 3pcs/pack
3200043508	—	Electrode protection caps, 5pcs/pack

\*Sensors carry 6-month warranty against manufacturing defects.



300-BNC Sensor Head Adapter



X-51 Digital Simulator



Flow Cell



Black pH sensor tip guard

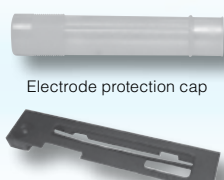

Printer ink ribbon



Printer paper



25-pin D-sub printer cable



Printer



10-m sensor head extension cable

With over 60 years of engineering excellence, HORIBA's diverse range of water quality analyzers and electrodes are ideal for everyday laboratory needs through to the most demanding of applications. Visit our website for a wealth of useful information and water quality measurement tips to help you obtain the best results in your work.

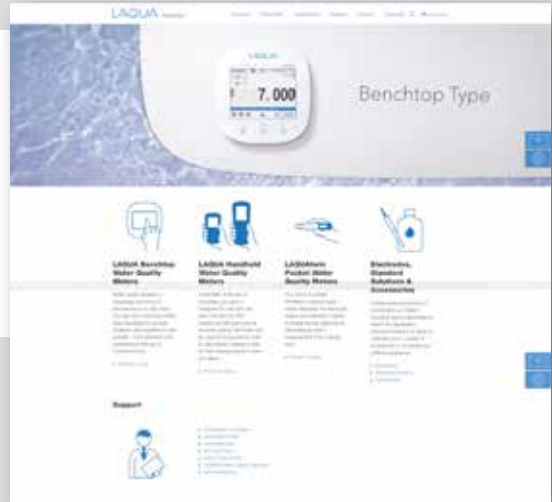

**Benchtop Meters**

Developed using extensive feedback from users, our new LAQUA meters deliver the best solution for water quality analysis. Our LAQUA website features an online 'Selection Guide' to enable you to find the perfect LAQUA meter and electrode for your need.



**Handheld Meters**

In the lab, in the field or anywhere you need it. LAQUA Handheld meters are designed for use with one hand and with an IP67 waterproof rating and shock-resistant casing. Meters can be used for long periods, even in dark places, making it ideal for field measurements in rivers and lakes.



**Pocket Meters**

Analyzing water quality is simplified when using our LAQUAtwin range of meters. Designed to produce accurate and reliable results. Anyone, anywhere, at any time can measure samples easily with a LAQUAtwin meter. See just how good they are at our website.



**Electrodes**

Various electrodes to match any application. A wide range of products for both benchtop and portable systems are available, including easy and reliable standard models, application-focused models for small samples or large containers, and special electrodes for specific sample characteristics.



**Application Notes**

LAQUAtwin pocket meters offer quick and convenient alternative to analyze important parameters with high accuracy. Several application notes are available at (<http://goo.gl/znwE6j>) detailing the use of LAQUAtwin and the results achieved for the respective applications. Additional application notes will be added when available.



Visit the **HORIBA LAQUA Singapore** Channel on YouTube and subscribe to see more of our videos.



**RoHS**

- The contents of this catalog are subject to change without prior notice, and without any subsequent liability to this company.
- The color of the actual products may differ from the color pictured in this catalog due to printing limitations.
- It is strictly forbidden to copy the content of this catalog in part or in full.
- All brand names, product names and service names in this catalog are trademarks or registered trademarks of their respective companies.
- Windows is a registered trademark of Microsoft Corporation in the United States and other countries.



■ **Asia Pacific**

**HORIBA Instruments (Singapore) Pte. Ltd.**  
83 Science Park Drive, #02-02A,  
The Curie, Singapore 118258  
Phone: 65 6908-9660 Fax: 65 6745-8155  
e-mail: [laqua@horiba.com](mailto:laqua@horiba.com)

■ **Europe, Middle East, & Africa**

**HORIBA UK Limited**  
Kyoto Close, Moulton Park,  
Northampton NN3 6FL  
Phone: +44 1604 642500  
e-mail: [waterquality@horiba.com](mailto:waterquality@horiba.com)